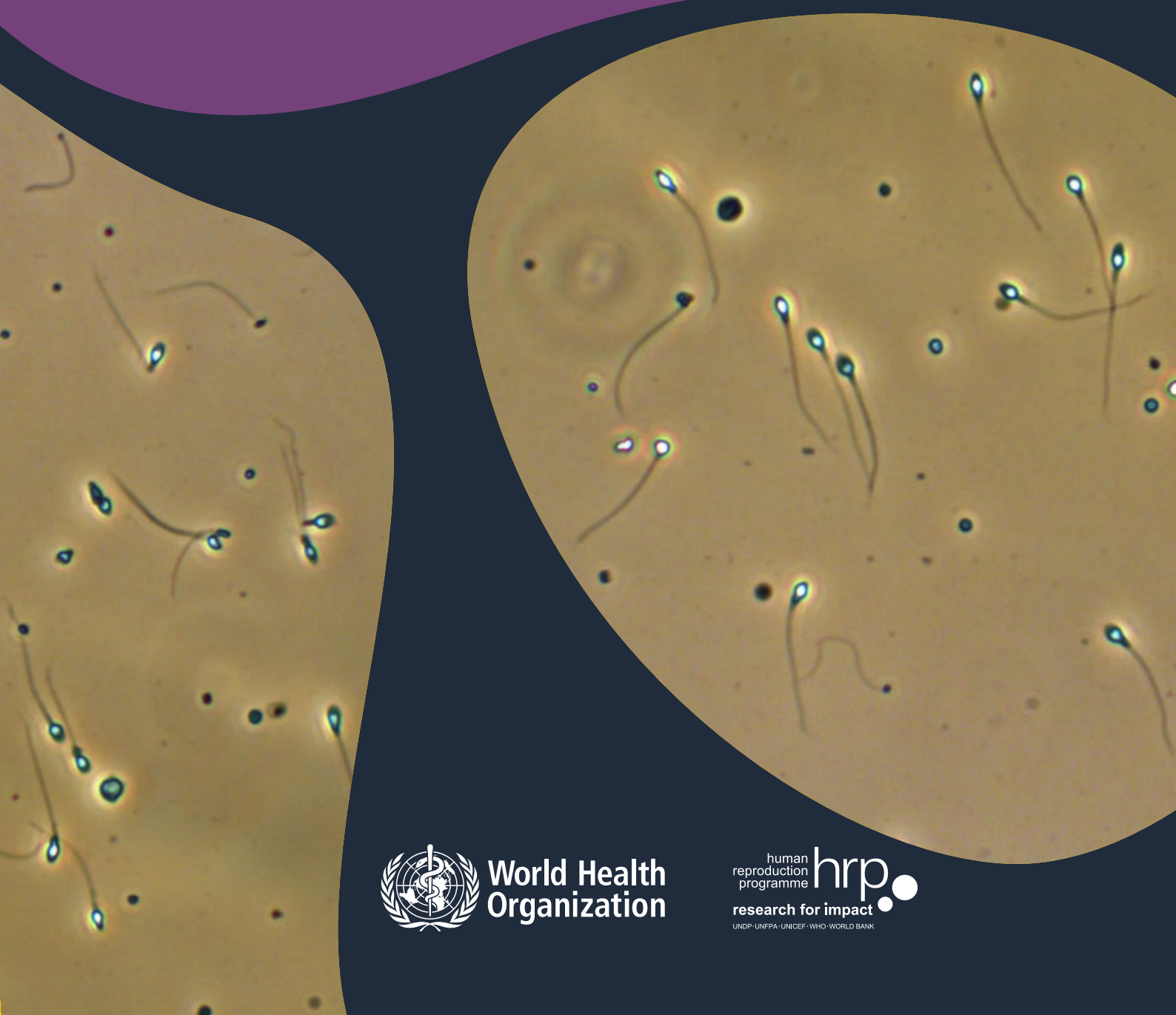


# WHO laboratory manual for the **examination and processing of human semen**

**Sixth Edition**



**World Health  
Organization**

human  
reproduction  
programme **hrp**  
research for impact  
UNDP · UNFPA · UNICEF · WHO · WORLD BANK



# WHO laboratory manual for the **examination and processing of human semen**

**Sixth Edition**



WHO laboratory manual for the examination and processing of human semen, Sixth Edition

ISBN 978-92-4-003078-7 (electronic version)

ISBN 978-92-4-003079-4 (print version)

© World Health Organization 2021

Some rights reserved. This work is available under the Creative Commons Attribution-NonCommercial-ShareAlike 3.0 IGO licence (CC BY-NC-SA 3.0 IGO; <https://creativecommons.org/licenses/by-nc-sa/3.0/igo>).

Under the terms of this licence, you may copy, redistribute and adapt the work for non-commercial purposes, provided the work is appropriately cited, as indicated below. In any use of this work, there should be no suggestion that WHO endorses any specific organization, products or services. The use of the WHO logo is not permitted. If you adapt the work, then you must license your work under the same or equivalent Creative Commons licence. If you create a translation of this work, you should add the following disclaimer along with the suggested citation: "This translation was not created by the World Health Organization (WHO). WHO is not responsible for the content or accuracy of this translation. The original English edition shall be the binding and authentic edition".

Any mediation relating to disputes arising under the licence shall be conducted in accordance with the mediation rules of the World Intellectual Property Organization (<http://www.wipo.int/amc/en/mediation/rules/>).

**Suggested citation.** WHO laboratory manual for the examination and processing of human semen, sixth edition. Geneva: World Health Organization; 2021. Licence: [CC BY-NC-SA 3.0 IGO](https://creativecommons.org/licenses/by-nc-sa/3.0/igo).

**Cataloguing-in-Publication (CIP) data.** CIP data are available at <http://apps.who.int/iris>.

**Sales, rights and licensing.** To purchase WHO publications, see <http://apps.who.int/bookorders>. To submit requests for commercial use and queries on rights and licensing, see <http://www.who.int/about/licensing>.

**Third-party materials.** If you wish to reuse material from this work that is attributed to a third party, such as tables, figures or images, it is your responsibility to determine whether permission is needed for that reuse and to obtain permission from the copyright holder. The risk of claims resulting from infringement of any third-party-owned component in the work rests solely with the user.

**General disclaimers.** The designations employed and the presentation of the material in this publication do not imply the expression of any opinion whatsoever on the part of WHO concerning the legal status of any country, territory, city or area or of its authorities, or concerning the delimitation of its frontiers or boundaries. Dotted and dashed lines on maps represent approximate border lines for which there may not yet be full agreement.

The mention of specific companies or of certain manufacturers' products does not imply that they are endorsed or recommended by WHO in preference to others of a similar nature that are not mentioned. Errors and omissions excepted, the names of proprietary products are distinguished by initial capital letters.

All reasonable precautions have been taken by WHO to verify the information contained in this publication. However, the published material is being distributed without warranty of any kind, either expressed or implied. The responsibility for the interpretation and use of the material lies with the reader. In no event shall WHO be liable for damages arising from its use.

Graphic Design by Lushomo

# Contents

<b>From the World Health Organization .....</b>	<b>vii</b>
<b>Acknowledgements .....</b>	<b>viii</b>
<b>Acronyms and abbreviations used in this manual .....</b>	<b>xii</b>
<b>Chapter 1: Introduction .....</b>	<b>1</b>
1.1 Scope of the manual.....	1
1.2 Introduction.....	1
1.3 The sixth edition.....	2
1.4 Methodology for the preparation of the sixth edition of the <i>WHO laboratory manual for the examination and processing of human semen</i> .....	4
<b>Chapter 2: Basic examination .....</b>	<b>9</b>
2.1 Introduction.....	9
2.2 Temporal outline of basic semen examination .....	12
2.3 Pre-examination procedures.....	13
2.4 Examination and post-examination procedures.....	15
2.5 Additional information and comments .....	64
<b>Chapter 3: Extended examination .....</b>	<b>83</b>
3.1 Indices of multiple sperm defects.....	83
3.2 Sperm DNA fragmentation.....	86
3.3 Genetic and genomic tests .....	105
3.4 Tests related to immunology and immunological methods .....	108
3.5 Assessment of interleukins – marker of male genital tract inflammation .....	116
3.6 Assessment of immature germ cells in the ejaculate .....	118
3.7 Testing for antibody coating of spermatozoa.....	119
3.8 Biochemical assays for accessory sex gland function.....	125
3.9 Assessment of sequence of ejaculation.....	135
<b>Chapter 4: Advanced examinations .....</b>	<b>139</b>
4.1 Seminal oxidative stress and reactive oxygen species testing.....	140
4.2 Assessment of the acrosome reaction.....	144
4.3 Assessment of sperm chromatin .....	149
4.4 Transmembrane ion flux and transport in sperm.....	152
4.5 Computer-aided sperm analysis (CASA) .....	155
4.6 Emerging technologies .....	159

**Chapter 5: Sperm preparation techniques ..... 161**

5.1 Introduction..... 161  
5.2 General principles..... 163  
5.3 Simple washing ..... 164  
5.4 Direct swim-up..... 165  
5.5 Discontinuous density gradients..... 166  
5.6 Magnetic activating cell sorting (MACS)..... 166  
5.7 Preparing HIV-infected semen samples..... 167  
5.8 Preparing testicular and epididymal spermatozoa ..... 167  
5.9 Preparing retrograde ejaculation samples..... 169  
5.10 Preparing assisted ejaculation samples..... 170

**Chapter 6: Cryopreservation of spermatozoa ..... 171**

6.1 Introduction..... 171  
6.2 Reasons for cryopreservation of spermatozoa..... 172  
6.3 Risk assessment of cryopreservation and storage of human semen..... 174  
6.4 Semen cryopreservation protocols..... 177  
6.5 Vitrification..... 182

**Chapter 7: Quality assurance and quality control..... 185**

7.1 Controlling for quality in the andrology laboratory..... 185  
7.2 The nature of errors in ejaculate examination ..... 188  
7.3 The QA programme..... 190  
7.4 QC charts for numerical values ..... 193  
7.5 QC charts for percentages ..... 197  
7.6 Assessing  $X_{\text{bar}}$  and S charts ..... 197  
7.7 Statistical procedures for analysing and reporting between-technician variability..... 199  
7.8 External quality control and quality assurance ..... 204  
7.9 Frequency and priority of quality control..... 205  
7.10 Training ..... 206

**Chapter 8: Appendices..... 211**

8.1 Interpretation of semen examination results ..... 211  
8.2 Equipment and safety ..... 214  
8.3 Microscopy for basic ejaculate examination ..... 221  
8.4 Stock solutions and media ..... 226  
8.5 Template for a semen analysis recording form..... 233  
8.6 QC material ..... 235  
8.7 National external quality control programmes for semen analysis..... 246

**Chapter 9: References..... 247**

# List of Tables

Table 2.1	Sufficient volumes of ejaculates – final volumes of diluted sperm suspensions for adequate handling.....	20
Table 2.2	Acceptable differences (based on 95% confidence interval) between two percentages for a given average, determined from replicate counts of 200 spermatozoa (total 400 counted) .....	26
Table 2.3	Comparison of difference between replicate counts and relation to uncertainty of result.....	33
Table 2.4	Calculation of sperm concentration from sperm count .....	35
Table 2.5	Fixation and Papanicolaou staining steps .....	47
Table 2.6	Classification of sperm morphology.....	51
Table 2.7	Papanicolaou plate 1 .....	56
Table 2.8	Papanicolaou plate 2 .....	58
Table 2.9	Papanicolaou plate 3 .....	60
Table 2.10	Papanicolaou plate 4 .....	61
Table 2.11	Papanicolaou plate 5 .....	61
Table 2.12	Probability of undetected spermatozoa from scanning wet preparations .....	66
Table 2.13	Probability of undetected spermatozoa after centrifugation .....	66
Table 2.14	Shorr plate .....	73
Table 2.15	DiffQuick plate .....	76
Table 2.16	Rounded sampling errors (%) and 95% confidence interval limits, according to total number of spermatozoa counted .....	78
Table 3.1	Calculation of indices of multiple sperm defects .....	85
Table 3.2	Sperm defect indices for men from fertile and infertile couples .....	86
Table 3.3	Basic levels of sperm chromosome disomy of healthy fertile men .....	107
Table 3.4	How much semen to use for an immunobead test .....	122
Table 3.5	Recommended standards for zinc assessments.....	127
Table 3.6	Recommended standards for fructose assessments.....	130
Table 3.7	Recommended standards for assessment of $\alpha$ -glucosidase activity.....	133
Table 7.1	Terminology of quality assurance and quality control .....	187
Table 7.2	Calculations of values for an $X_{\bar{c}}$ chart.....	194
Table 7.3	The factors necessary for calculation of warning and action limits for the $X_{\bar{c}}$ chart.....	195
Table 7.4	The calculation of warning and action limits for the $S$ chart .....	196
Table 7.5	Basic control rules for QC charts.....	198
Table 7.6	Sperm concentrations ( $\times 10^6/\text{ml}$ ) estimated by three members of staff on five QC samples .....	202
Table 7.7	Differences from sample mean computed by subtracting semen sample mean from each observation ....	202
Table 7.8	Mean, SD and the mean/standard error of these differences computed for each member of staff ( $n =$ number of samples).....	202
Table 7.9	Mean, SD and the mean/standard error of these differences computed for each member of staff ( $n =$ number of samples) .....	202
Table 7.10	The F-test from the two-way ANOVA for technicians and QC samples.....	203
Table 7.11	A summary of main features of IQC procedures.....	203
Table 7.12	Time schedule for QC .....	206
Table 7.13	Summary of QC tests .....	206
Table 7.14	Sources of variation (error) in assessing sperm concentration.....	208
Table 7.15	Sources of variation (error) in assessing sperm morphology.....	209
Table 7.16	Sources of variation (error) in assessing sperm motility .....	210
Table 7.17	Sources of variation (error) in assessing sperm vitality .....	210
Table 8.1	Definition of reference population in Campbell et al. (5).....	212
Table 8.2	Origin of data for the distribution of results (5) .....	212
Table 8.3	Distribution of semen examination results from men in couples starting a pregnancy within one year of unprotected sexual intercourse leading to a live birth. From Campbell et al. (5); fifth percentile given with variability (95% confidence interval) .....	213
Table 8.4	Example template for a semen analysis report form.....	233

# List of Figures

Fig. 2.1	Non-specific aggregation of spermatozoa in semen .....	21
Fig. 2.2	Schematic diagram of different extents of sperm agglutination .....	22
Fig. 2.3	Aids to assessing sperm motility.....	25
Fig. 2.4	Eosin–nigrosin smear observed in brightfield optics .....	27
Fig. 2.5	The haemocytometer with improved Neubauer ruling .....	30
Fig. 2.6	Which spermatozoa to count in the grid squares.....	31
Fig. 2.7	Scanning the entire coverslip for the presence of motile spermatozoa.....	37
Fig. 2.8	Morphologically "ideal" spermatozoa .....	43
Fig. 2.9	Preparing a normal semen smear .....	44
Fig. 2.10	Schematic drawings of some abnormal forms of human spermatozoa.....	50
Fig. 2.11	Structured order for the assessment of human sperm morphology .....	53
Fig. 2.12	Papanicolaou plate 1.....	55
Fig. 2.13	Papanicolaou plate 2.....	57
Fig. 2.14	Papanicolaou plate 3.....	59
Fig. 2.15	Papanicolaou plate 4.....	62
Fig. 2.16	Papanicolaou plate 5.....	63
Fig. 2.17	Schematic representation of typical morphological changes in human spermatozoa subjected to hypo-osmotic stress.....	70
Fig. 2.18	Photo micrographs under phase contrast microscope of spermatozoa subjected to hypo-osmotic stress .....	71
Fig. 2.19	Shorr plate.....	72
Fig. 2.20	DiffQuick plate .....	75
Fig. 3.1	TUNEL slide assay for DNA fragmentation using fluorescence .....	88
Fig. 3.2	Flow cytometry for analysis of Propidium Iodide and green fluorescence .....	90
Fig. 3.3	Sperm with (intact DNA, arrow) and without halo (fragmented DNA, arrowheads) .....	98
Fig. 3.4	Comet assay of sperm from an abnormal with extensive DNA fragmentation and normal male lacking visible DNA damage stained with ethidium bromide .....	102
Fig. 3.5	Comet as seen under a microscope, subsequent scoring with CASP software (tail DNA = 88%) .....	102
Fig. 3.6	Peroxidase-positive cells in human semen .....	110
Fig. 3.7	Leukocytes in semen .....	115
Fig. 3.8	Two examples of split-ejaculate collection devices .....	136
Fig. 3.9	Example of graphic representation of results of a normal four-fraction split-ejaculate, showing the distribution of volume, spermatozoa, progressive motility, zinc and fructose .....	137
Fig. 4.1	Examples of FITC-PNA-stained acrosome-intact and acrosome-reacted, viable and unviable spermatozoa .....	147
Fig. 4.2	Example of AB-positive (a) and AB-negative (b) spermatozoa at optical microscopy (×1000, oil immersion) .....	150
Fig. 4.3	Examples of CMA3-positive (a) and CMA3-negative (b) spermatozoa (left panel) .....	152
Fig. 4.4	Standard terminology for variables measured by CASA systems .....	157
Fig. 4.5	Examples of graphical expressions of different CASA applications.....	160
Fig. 7.1	An $\bar{X}_{\text{bar}}$ chart based on data from Table 7.1 .....	195
Fig. 7.2	An S chart for sperm concentration .....	197
Fig. 7.3	A Bland-Altman plot of manual and CASA estimates of percentage progressive sperm motility .....	200
Fig. 7.4	A Youden plot of estimates of the concentration of spermatozoa .....	201
Fig. 8.1	Nomogram for determining centrifugal force from rotor radius and rotation speed .....	218
Fig. 8.2	Section of a microscope .....	222
Fig. 8.3	Aids to assessing sperm motility.....	237
Fig. 8.4	View through an ocular with reticle (red grid).....	239
Fig. 8.5	View of the videotaped image of the stage micrometer on the monitor and the drawn overlay .....	239



# From the World Health Organization

Access to high-quality, evidence-based, affordable health services is key for Universal Health Coverage (UHC), including for sexual and reproductive health. Universal access to laboratory services is essential to ensure that concerned populations can avoid the adverse health and socioeconomic consequences of sexual and reproductive ill health.

The *WHO laboratory manual for the examination of human semen and sperm – cervical mucus interaction* was first published in 1980, in response to a growing need for standardization of procedures for the examination of human semen. The manual has subsequently been revised four times (in 1987, 1992, 1999 and 2010), and translated into a number of languages.

The manual is a reference document for procedures and methods for the laboratory examination and processing of human semen, which are intended to maintain and sustain the quality of analysis and the comparability of results from different laboratories. Indeed, over the past 40 years, the manual has become a recognized standard and is used extensively by clinical and research laboratories throughout the world.

It is a standard manual not only for those new to semen analysis, but also for all who process and examine semen to define its parameters for clinical use or research studies. The manual provides important information on semen examination and preparation for clinical evaluation, specialized assays, cryopreservation, quality control in the semen analysis laboratory, and laboratory examination in the investigation of male infertility. These are also critical in monitoring the response to treatment and other interventions that aim to improve male sexual and reproductive health.

This sixth edition of the manual will be an essential source of the latest evidence-based information for the laboratory procedures needed for fertility care. This edition has new and expanded sections on semen sample preparation, determining markers for infection, computer-aided sperm analysis, and basic extended and advanced categories.

The sixth edition of the *WHO Manual for the Laboratory Examination and Processing of Human Semen* will benefit programmes that seek to improve sexual and reproductive health, including fertility care and access, especially among males, thereby supporting countries' efforts to attain SDG 3.7 (universal access to sexual and reproductive health care services, including for family planning). The manual will also support accomplishment of SDG 3.8 (universal health coverage, including financial risk protection, and access to quality essential health care services).

WHO and HRP would like to thank the many technical experts from around the world who contributed to the review and revision of this manual.

**Ian Askew, PhD**  
**Director, Department of Sexual and Reproductive Health and Research,**  
**including the UNDP/UNFPA/UNICEF/WHO/World Bank Special Programme on**  
**Human Reproduction**  
**World Health Organization**

# Acknowledgements

This publication was produced by the Department of Sexual and Reproductive Health and Research of the World Health Organization (which includes the UNDP/UNFPA/UNICEF/WHO/World Bank Special Programme of Research, Development and Research Training in Human Reproduction – HRP). The participation of the following individuals in the preparation, editing and revision of this manual is greatly acknowledged.

## **Editor-in-Chief:**

### **Dr. Lars Björndahl, MD, PhD**

Laboratory medicine

Andrology Laboratory Director

ANOVA, Clinic for Endocrinology, Karolinska University Hospital and Department of Medicine, Huddinge, Karolinska Institutet, Stockholm, Sweden

## **Editorial board:**

### **Professor Oleg Apolikhin, MD, PhD**

Andrology

Professor and Director, Research Institute of Urology and Interventional Radiology named after N.A. Lopatkin – branch of the National Medical Research Center of Radiology of the Ministry of Health of the Russian Federation  
Moscow, Russian Federation

### **Professor Elisabetta Baldi, Doctor in Biology**

Laboratory medicine

Associate Professor of Clinical Pathology, Department of Experimental and Clinical Medicine, University of Florence

Responsible of the semen cryopreservation centre, Azienda Ospedaliero-Universitaria Careggi (AOUC)

Florence, Italy

### **Professor Christopher L.R. Barratt PhD, DSc, FRSE**

Head of Division Systems Medicine, Professor of Reproductive Medicine

School of Medicine, University of Dundee

Dundee, United Kingdom

### **Professor Mario Philip R. Festin, MD, MSc, MHPEd**

Obstetrics-gynaecology, clinical epidemiology, health professions education, family planning

Professor, Department of Obstetrics and Gynecology and Department of Clinical Epidemiology, College of Medicine, University of the Philippines Manila

Convenor, Philippine Study Group on Reproductive Health, National Institutes of Health, University of the Philippines

Manila, Philippines

WHO Secretariat Consultant

### **Dr. Jackson C. Kirkman-Brown, MBE, PhD**

Reproductive science, andrology, health care science, fertility

University Reader and Director, Centre for Human Reproductive Science (ChRS), College of Medical and Dental Sciences, University of Birmingham

HFEA Person Responsible and Science Lead, Birmingham Women's Fertility Centre, Birmingham Women's and Children's NHS Foundation Trust

Birmingham, United Kingdom

**Professor Dolores J. Lamb, MS, PhD, HCLD (ABB)**

Andrology/urology, clinical chemistry (National Registry of Clinical Chemistry)  
High Complexity Laboratory Director (HCLD, American Board of Bioanalysts)  
Dow Professor of Urology  
Vice-Chairman for Research (Urology)  
James Buchanan Brady Foundation Department of Urology, Director, Center for  
Reproductive Genomics, Englander Institute for Precision Medicine  
Weill Cornell Medical College  
New York, United States of America  
American Society for Reproductive Medicine

**Dr. Michael Mbizvo, PhD**

Andrology and reproductive epidemiology  
Professor, Reproductive Health Sciences, University of Zimbabwe  
Country Director/Senior Associate, Population Council  
Lusaka, Zambia

**Prof. Dr. Stefan Schlatt, PhD**

Reproductive biology, andrology  
University Professor and Director, Centre for Reproductive Medicine and Andrology,  
University of Münster, Germany  
WHO Collaborating Centre for Research in Male Reproduction

**Dr. Igor Toskin, MD, PhD, DSc**

Public health, STI, HIV/AIDS, urology, dermatology, epidemiology, sexual and  
reproductive health  
Scientist, Department of Sexual and Reproductive Health and Research  
World Health Organization  
Geneva, Switzerland  
WHO Secretariat

**Dr. Christina Wang, MD**

Endocrinology, andrology (male reproduction and contraception)  
Professor of Medicine, David Geffen School of Medicine, UCLA  
Division of Endocrinology, Department of Medicine, Harbor-UCLA Medical Center  
and the Lundquist Institute  
Torrance California, United States of America

**Contributors**

**Karel Blondeel, MSc, MA**

HIV/STI prevention and sexual health  
Doctoral student, Department of Medicine and Health Sciences, Ghent University  
Ghent, Belgium  
WHO Secretariat Consultant

**MUDr. Petr Houska**

Laboratory medicine  
Doctoral student, ANOVA, Clinic for Endocrinology, Karolinska University Hospital  
and Department of Medicine, Huddinge, Karolinska Institutet  
Stockholm, Sweden

**Dr. Stepan Krasnyak, MD**

Andrology, urology

Associate Scientist, Department of Andrology and Human Reproduction, Research Institute of Urology and Interventional Radiology named after N.A. Lopatkin – branch of the National Medical Research Center of Radiology of the Ministry of Health of the Russian Federation

Moscow, Russian Federation

The team would like to acknowledge Ian Askew, James Kiarie and Thabo Matsaseng for their support in meetings and discussions in the department.

Special thanks to Mrs. Natalie Narkie Maurer, Assistant and Secretary at the Department of Sexual and Reproductive Health and Research, World Health Organization, Geneva, Switzerland.

The support, advice and assistance of Susan Norris, Rebekah Thomas and Ian David Coltart of WHO are highly appreciated.

Special thanks to former WHO staff member Dr. Kirsten Vogelsong for her excellent record-keeping of the previous editions of the manual, which facilitated revision for the latest edition, and to the editor of the fifth edition of the manual, Dr. Trevor Cooper, for helping with the data and other items that were important in the continuity of this new edition.

The Department of Sexual and Reproductive Health and Research of the World Health Organization (which includes the UNDP/UNFPA/UNICEF/WHO/World Bank Special Programme of Research, Development and Research Training in Human Reproduction – HRP) would like to acknowledge all participants in the public review for their contributions.

Additional thanks to:

- Dr. Christoph Brenker, Postdoctoral Scientist, Centre for Reproductive Medicine and Andrology, University of Münster (for assistance with staining protocols, taking micrographs and plates for documentation of spermatozoal pathologies)
- Dr. Meurig Gallagher, Research Fellow, Centre for Systems Modelling and Quantitative Biomedicine, University of Birmingham (for help in writing the sperm motility and CASA sections)
- Dr. Monica Muratori, Research Assistant, Department of Experimental and Clinical Medicine, University of Florence (for assistance in writing the Tunel protocol for sperm DNA fragmentation)
- Dr. Sara Marchiani, Research Assistant, Department of Experimental and Clinical Medicine, University of Florence (for help in writing the protocol for sperm chromatin status evaluation).



**Dr. Christina Wang, MD**

This is the sixth edition of the *WHO Manual for the examination and processing of human semen*. The manual has been one of the most downloaded documents at the WHO website in past years.

Dr. Christina Wang has been involved with the manual since its first edition in 1980 (when it was the *WHO laboratory manual for the examination of human semen and sperm-cervical mucus interaction*) and continues to be part of the present sixth edition, as an active member of the manual's editorial board.

Dr. Wang is Professor of Medicine at the David Geffen School of Medicine at the University of California at Los Angeles. She is with the Division of Endocrinology, in the Department of Medicine, and the Site Director of the Clinical and Translational Science Institute at the Lundquist Institute at Harbor-UCLA Medical Center.

Dr. Wang is an internationally recognized investigator in male reproductive medicine and biology, and for many years she has continued to lead the efforts to develop a safe, effective and reversible hormonal male contraceptive, optimal methods of male hormone replacement therapy and new androgen replacement for hypogonadal men. In addition to all the above, Dr. Wang has been leading several other impactful research projects and initiatives – ranging from basic research to clinical trials – that aim to improve reproductive health outcomes.

The World Health Organization would like to acknowledge Dr. Wang's outstanding contribution to the development of all six editions of the *WHO Manual for the examination and processing of human semen*. Her contribution ensured both a high level of technical expertise in the development of the manual and also institutional continuity throughout all editions of this important document.

# Acronyms and abbreviations used in this manual

<b>ART</b>	assisted reproductive technology
<b>BSA</b>	bovine serum albumin
<b>BWW</b>	Biggers, Whitten and Whittingham
<b>CASA</b>	computer-aided sperm analysis
<b>CASMA</b>	computer-aided sperm morphometric assessment
<b>CD45</b>	cluster of determination 45 (pan-leukocyte marker)
<b>CD46</b>	cluster of determination 46 (acrosomal antigen)
<b>CMA3</b>	chromomycin A3
<b>DGC</b>	density-gradient centrifugation
<b>DNA</b>	deoxyribonucleic acid
<b>DNase</b>	desoxyribonuclease
<b>DPBS</b>	Dulbecco's phosphate-buffered saline
<b>DTT</b>	dithiothreitol
<b>EBSS</b>	Earle's balanced salt solution
<b>EDTA</b>	ethylenediamine tetra-acetic acid
<b>EQA</b>	external quality assessment
<b>EQC</b>	external quality control
<b>FITC</b>	fluorescein isothiocyanate
<b>GEYC</b>	glycerol-egg yolk-citrate
<b>HIV</b>	human immunodeficiency virus
<b>HPF</b>	high-power field
<b>HSA</b>	human serum albumin
<b>HTF</b>	human tubal fluid
<b>ICSI</b>	intracytoplasmic sperm injection
<b>Ig</b>	immunoglobulin
<b>IQC</b>	internal quality control
<b>IU</b>	international unit
<b>IUI</b>	intrauterine insemination
<b>IVF</b>	in vitro fertilization
<b>NA</b>	numerical aperture
<b>QC</b>	quality control
<b>sEBSS</b>	supplemented Earle's balanced salt solution
<b>SD</b>	standard deviation
<b>sDF</b>	sperm DNA Fragmentation
<b>SOP</b>	standard operating procedure
<b>TZI</b>	teratozoospermia index
<b>WHO</b>	World Health Organization



# Chapter 1: Introduction

1.1 Scope of the manual.....	1
1.2 Introduction .....	1
1.3 The sixth edition.....	2
1.4 Methodology for the preparation of the sixth edition of the <i>WHO laboratory manual for the examination and processing of human semen</i> .....	4

## 1.1 Scope of the manual

The overall aim of the manual is to describe laboratory methods for examination of the ejaculate, to contribute to global improvement in assessment of male reproductive function and treatment of male factor subfertility.

The methods provided here can be used as standard operating procedures not only for andrology laboratories but for any laboratory performing semen examination. The basic methods described in Chapter 2, when adopted and practised in laboratories, may improve the quality of semen examination and comparability of results across many laboratories. The extended semen assessment methods and research tests described in the subsequent chapters are included for technologists, scientists and clinicians who require more information on the functional capacity of spermatozoa and male reproductive organs. This information may be useful for investigating male factor subfertility, as well as for monitoring sperm parameters during the use of male contraceptive methods and in epidemiological studies on male reproductive health.

## 1.2 Introduction

The *WHO laboratory manual for the examination of human semen and sperm-cervical mucus interaction* was first published in 1980, in response to a growing need for standardization of procedures for the examination of human semen. The manual was revised four times (1-5), widely read and translated into a number of languages. Indeed, over the past 40 years, the manual became a recognized standard, used extensively by clinical and research laboratories throughout the world. It is a procedural guide not only for those new to semen analysis, but a reference text for all who process semen and need to analyse and define sperm parameters for clinical practice or clinical and epidemiological research studies.

Semen examination is important for different reasons:

- assessment of male reproductive function and genital tract patency to enable appropriate treatment for male subfertility and to monitor treatment response;
- appraisal of fertility potential and choice of suitable treatment modality for an infertile couple;



- measure efficacy of male contraception (e.g. vas occlusion and interventions including hormonal male contraception and other potential methods).

The clinical assessment of the male together with the semen analyses can guide the clinician to determine how to proceed with further investigation and management of the subfertile couple. The previous edition of this manual provided reference ranges for the commonly measured sperm variables based on data characterizing semen parameters of men whose partners had a time to pregnancy of 12 months or less. These distributions of values were defined according to standard methods used in clinical chemistry for the definition of reference ranges, but importantly they cannot be used as distinct limits between fertile and subfertile men (6). Although the semen and sperm parameters were not derived from many geographical areas allowing representativity of men from most populations, these distributions of values have been used globally. In addition, many known and unknown female factors hamper the value of using only semen examination parameters to predict the prognosis for the couple of spontaneous or assisted fertilization. A better prognostic value of semen examination can be obtained from using the combination of several parameters (7-9). The present methods for semen examination can provide many answers, but there are many questions that require other investigations (10). For an individual patient, a semen analysis is never prognostic of fertility, as it is the fertility potential of the couple that defines them as fertile or subfertile.

Despite success of prior manuals, it has become apparent that the previous edition did not provide the optimal format for a laboratory technician or scientist to perform a step-by-step semen examination procedure in a laboratory. In addition, over the past 10 years many new sperm-based tests have been validated for clinical and research purposes that should be discussed in the manual. Prompted by these considerations, WHO established an editorial committee with support from the WHO Secretariat to review all the methods described in the manual, with a view to endorsing, changing or updating them. When insufficient data were obtained using the methods described in the manual or not validated in more than one laboratory, the editorial committee developed a consensus position after evaluating the pertinent literature. In addition, an updated review of the distribution of results for semen and sperm parameters from presumed fertile men was conducted to include data from all populations whenever possible.

The lack of clear instructions on the order in which analyses should be performed when a semen sample is delivered to the laboratory led some laboratories to use methodologies described in other resources. Other laboratories developed their own versions of these methods, while still claiming to perform semen analysis according to the WHO manual (11). To make global comparisons easier, this new edition of the manual therefore includes step-by-step procedures and checklists to ensure it is user-friendly for laboratory technicians and scientists.

## 1.3 The sixth edition

The sixth edition comprises three parts: semen examination (**Chapter 2, 3 and 4**), sperm preparation and cryopreservation (**Chapters 5 and 6**) and quality assessment and quality control (**Chapter 7**). Procedures for semen examination are divided into three chapters: basic examinations, which are robust routine procedures for determining semen variables that not only andrology but any laboratory performing a semen examination can follow; extended analyses, which may be used in certain situations by choice of the laboratory or by special request from the clinician; and advanced examinations, which are not currently regarded as routine for use in





the initial evaluation of a subfertile male. As semen culture is not performed in an andrology laboratory, this is mentioned only in the section on sterile collection of semen. The section on sperm preparation extends beyond the ejaculate to include spermatozoa obtained from the testis and epididymis. Notably, human cervical mucus tests were eliminated from this new edition because they are no longer used in clinical practice. This new edition is written as an easy-to-follow procedural manual for those performing semen examination, with background information and rationale of the test separated from the description of the procedure.

The main features of this sixth edition are outlined below.

- The chapters on **semen examination** include details of how to proceed with step-by-step procedures, calculations and interpretation, so that any given methodology is essentially complete, with minimal cross-reference to other parts of the manual.
- **Basic examinations**
  - *Assessment of sperm numbers:*
    - Semen dilutions have been simplified, but 200 spermatozoa per replicate should be counted.
    - It is important that the laboratory does not stop assessing the number of sperm at low concentrations (2 million/ml), as suggested in the past edition, but report lower concentrations, noting that the errors associated with counting a small number of spermatozoa may be very high. Additional methods described in this chapter may be necessary to improve the accuracy and precision of very low sperm numbers.
    - The total sperm numbers per ejaculate (sperm output) have more diagnostic value than sperm concentration, but for this, semen volume must be measured accurately.
    - The section *for assessment of azoospermia* is retained, and *procedures for centrifugation* and using *stains for live spermatozoa* are also included as methods for the detection of spermatozoa in unfixed samples for assessment of post-vasectomy semen or when sperm output is markedly suppressed by contraceptive agents.
  - *Assessment of sperm motility.* The categorization of sperm motility has reverted back to fast progressively motile, slow progressively motile, non-progressively motile and immotile (grade a, b, c or d) because presence (or absence) of rapid progressive spermatozoa is clinically important (12).
  - *Assessment of sperm morphology.* The procedure to assess sperm morphology using a systematic approach is described and should be followed. In this edition, more and better-quality micrographs of spermatozoa from unprocessed semen samples considered normal, borderline or abnormal are included, accompanied by explanations of why each spermatozoon has been classified the way it has. This should help in training technicians to consistently define subtle features of spermatozoal morphology.
- **Extended examinations.** This chapter was extensively revised and now contains not only procedures to detect leukocytes, immature germ cells, sperm antibodies, indices of multiple sperm defects, and biochemical assays for accessory organ function, but also methods to detect sperm aneuploidy and sperm genetics as well as DNA fragmentation.



- **Advanced examinations.** This section includes both examinations that are classified as focused on very specialized as well as mainly research methods and other emerging technologies. This chapter was extensively revised. Obsolete tests such as the human oocyte and human zona pellucida binding and the hamster oocyte penetration tests have been removed. Descriptions of these tests are available from the fifth edition. The research tests in this edition include assessment of reactive oxygen species and oxidative stress, membrane ion channels, acrosome reaction and sperm chromatin. *Computer-assisted sperm analysis (CASA)* has been rewritten to describe the principles of CASA and its use as a research technology. In addition, emerging new methods using sperm movement or changes in light may constitute the basis of measuring sperm motility without the need of a microscope.
- The chapters on sperm **preparation** and **cryopreservation** of spermatozoa were updated.
- **Quality control.** This chapter has been revised to be easier to approach for non-statisticians. Rigorous quality maintenance for semen examination is necessary for analytical methods to be robust. Both internal and external quality procedures should be practised. Hints and suggestions are given on how to improve laboratory performance when quality control results are unsatisfactory.
- **Decision limits more accurate than reference ranges and reference limits.** Distribution of results from presumed fertile men is not sufficient to establish clinically useful decision limits. Data characterizing the semen characteristics of a reference population (men whose partners had a time to pregnancy of 12 months or less) have been revised (**Section 8.1 on page 221**). Data not previously reported and from more diverse populations were incorporated, and these analyses validated the distribution of results defined in the fifth edition of the manual. Distribution of data from the population is presented with one-sided intervals (extremes of the reference population data), although these percentiles do not represent distinct limits between fertile and subfertile men.

## 1.4 Methodology for the preparation of the sixth edition of the *WHO laboratory manual for the examination and processing of human semen*

By Mario Philip R. Festin and Igor Toskin

The *WHO laboratory manual for the examination and processing of human semen* is now in its sixth edition. The fifth edition has been one of the most popular WHO publications since it came out in 2010, with steadily increasing downloads even in recent years (95 975 in 2018, 120 803 in 2019 and 132 765 in 2020).

It has been the standard manual used by andrology laboratories, but also by other laboratories performing semen analysis, clinics and research institutions worldwide. By 2021 it had been cited in over 3000 peer-reviewed papers and reviews. The manual has been disseminated at international congresses and scientific meetings and in training programmes of WHO collaborating centres, professional societies and other academic institutions.

For the present revision, the process included the following. The manual secretariat was convened by the WHO Department of Reproductive Health and Research (RHR),



based on a list derived from the previous editorial team, and upon consultation with collaborating institutions of the department. A plan to come up with a list of members of the proposed editorial board was drawn up.

This list of possible contributors to the next edition was derived from a scan of speakers at andrology congresses, a review of the contributors to the fifth edition of the manual, and a scan of the peer-reviewed global medical literature on andrology and semen analysis. The basis for the final selection included a track record of research and practice on semen analysis, peer-reviewed publications and internationally recognized technical expertise, with a balance between clinical practice and laboratory experience. There was an attempt to obtain a balance of andrologists, laboratory experts, urologists, scientists, epidemiologists and others.

A core editorial team of eight people was formed to start the organization of the larger team of writers if needed. The core editorial team was selected based on active collaboration with the department in recent years, and previous experience on the semen manual. The core editorial team nominated the rest of the members of the larger contributors' team, as needed. No honoraria or fees are provided to editorial board members or contributors.

Once the list of core editors was finalized, WHO invited them to become members of the editorial board, with specific terms of reference. Their CVs, individual agreements and statements of possible conflicts of interest were submitted and kept on file. Most of the communications would initially be through teleconferences, later to also include face-to-face meetings in Geneva or elsewhere.

The proposed tasks of the core editorial team of eight were:

- suggesting other members of the contributors' team, as needed
- setting criteria for selecting the general contributors
- identifying the topics for revision or updating
- devising the process for scoping this edition.

The members of the editorial board for the sixth edition of the *WHO laboratory manual for the examination and processing of human semen* were:

- Oleg Apolikhin – <https://ecuro.ru/en/node/3485>
- Elisabetta Baldi – <https://www.unifi.it/p-doc2-0-0-A-3f2a3d2a393028.html>
- Christopher Barratt – <https://www.dundee.ac.uk/people/christopher-barratt>
- Lars Björndahl – <https://ki.se/en/people/larsbjor>
- Jackson Kirkman-Brown – <https://www.birmingham.ac.uk/staff/profiles/metabolism-systems/kirkman-brown-jackson.aspx>
- Dolores Lamb – <https://urology.weillcornell.org/dolores-lamb>
- Michael Mbizvo – <https://www.popcouncil.org/research/expert/michael-mbizvo>



- Stefan Schlatt – <https://www.medizin.uni-muenster.de/cera/cera-forschung/experimentelle-und-translazionale-forschung-zum-hoden/arbeitsgruppe/univ-prof-dr-rer-nat-stefan-schlatt-1.html>
- Christina Wang – <https://lundquist.org/christina-chung-lun-wang-md>

At the WHO, the manual secretariat included Igor Toskin and Mario Festin.

Additional members were added to support the senior members of the editorial team and will be recognized as contributors:

- Petr Houska
- Stepan Krasnyak
- Karel Blondeel.

The terms of reference included:

- to review the classification and presentation of procedures to enhance comprehension among technical personnel;
- to prepare a clearer presentation of the illustrations and photographs;
- to optimize the use of the content presently found in boxes inserted in the main text, by incorporating it into the main text wherever appropriate;
- to verify and update the reference standard values from the previous edition.

The WHO RHR Secretariat consulted with the WHO Guidelines Review Committee (GRC), which decides whether a publication needs to follow the documentation, review and approval process for guidelines. Upon review, the GRC noted that the previous editions of the manual had addressed how to collect and prepare specimens, how to analyse specimens and interpretation, including reference values for numbers, morphology, motility and other characteristics. There were no recommendations on whether, when and how to treat abnormalities.

The manual has only provided standardized procedures to follow to conduct laboratory testing and examination, thus has not made clinical or practice recommendations, which is outside the scope of the manual, as mentioned by the GRC. It was advised that the conclusions and information in the manual still be based on the best available evidence, including citations as available. The manual would have to meet WHO standards for document development and publication, including declaration of conflicts of interests, management of external committees, WHO style, clearance process and others. It would have to be linked to current WHO guidelines on the management of infertility and contraception, as relevant. The manual would retain its objective of describing procedures and how to set local standards for reference values. WHO received confirmation from the GRC that the present format of the manual does not make it a guideline and would not require its clearance or approval.

Also at WHO, proper communications were made with the Laboratory Standards Department for guidance on content and procedures, especially on the setting of standards in a manual.



Planning clearance was secured with the Documents Committee of the WHO Department of Reproductive Health and Research, and executive clearance prior to publication was given, once the document was completed. Other publications from the reviews and discussions in the preparation of the manual will be decided and agreed on by the editorial board.

The editorial core team identified possible topics regarding factors affecting semen parameters. A review of the literature on specific research issues was done as part of the preparation for the manual. If certain issues or topics were discussed, a decision was based on consensus or open vote. To facilitate the process of data-sharing, review and updating, an electronic platform was established. The editorial team also considered other topics to be included, modified or removed from the present version of the manual. Several decisions were made regarding format, topics for inclusion, topics for exclusion, and timelines. A series of teleconferences, individual and group email exchanges, and two in-person meetings were conducted between 2017 and 2020.

A literature review was required on certain identified topics. This supported the editorial board on topics about which there may be some uncertainty, either because they were a very recent technological development or due to a lack of evidence or experience. These were the basis for discussions for some of the vital decisions to be made. Some of the topics for review included:

- newer procedures for assessment of quality of sperm; and
- factors affecting quality of sperm – environmental factors, use of drugs, age-related factors, health-related factors and others (as part of the manual or as separate review papers for publication).

Timelines were prepared for each chapter and for the full manual. They included:

- outline content of the chapters
- first draft submission
- review by the editorial core group
- second draft submission
- review by the editorial core group
- approval by the editor-in-chief
- review by the main editor for consistency across all chapters
- internal review by WHO
- external review by other technical experts on andrology or semen analyses
- public review (as part of the standard procedures in preparing WHO documents)
- finalization of the document after collation and synthesis of all reviews and comments.



Experts from 43 countries in all 6 WHO Regions participated in the public review.

While the manual appendix describes the distribution of results from men whose partners became pregnant within 12 months of trying (**Section 8.1 on p211**), to present a more detailed description of the efforts to re-examine and update the reference distributions, a separate paper was prepared by a separate group of authors, which included some of the members of the editorial board, with key findings mentioned in Appendix 8 (see reference below). Other topics that are outside the scope of the manual are also to be published separately, including a landscape analysis of emerging technologies.

Reference to the reference value distribution paper:

Campbell MJ, Lotti F, Baldi E, Schlatt S, Festin MPR, Björndahl L, Toskin I, Barratt CLR. Distribution of semen examination results 2020 - A follow up of data collated for the WHO semen analysis manual 2010. *Andrology*. 2021 May;9(3):817-822. doi: 10.1111/andr.12983. Epub 2021 Mar 17.



# Chapter 2:

## Basic examination

2.1 Introduction .....	9
2.2 Temporal outline of basic semen examination .....	12
2.3 Pre-examination procedures .....	13
2.4 Examination and post-examination procedures.....	15
2.5 Additional information and comments.....	64

Basic examinations are those that any laboratory investigating human ejaculates is expected to perform. The techniques described here are designed to provide the best combination of highest reliability and most practical execution. Although there may be alternative techniques with similar results, it is imperative that comparable methods are used to achieve clinical and scientific standardization. This approach provides the foundation for proper development of the science behind male reproductive care.



All aspects of ejaculate collection and examination must be assessed using properly standardized procedures if the results are to provide reliable information.



### 2.1 Introduction

In contrast to most other body secretions examined for the purpose of diagnosis or follow-up of treatment, the ejaculate is a heterogeneous mixture of secretions that does not exist within the body before being expelled. The ejaculate is produced from a concentrated suspension of spermatozoa, stored in the paired epididymides, mixed with, and diluted by, primarily the prostatic fluid in the urethra, followed by the emptying of the secretion of the seminal vesicles (13). Thus, the sequential ejaculate fractions are not equally composed. Comparison of pre- and post-vasectomy ejaculate volume reveals that about 90% of the volume is composed of secretions from the accessory organs (14), mainly the prostate and seminal vesicles, with minor contributions from the bulbourethral (Cowper's) glands and epididymides.

The ejaculate has two major quantifiable attributes.

- **The number of spermatozoa** reflects sperm production by the testes, the patency of the post-testicular duct system, the efficacy of smooth muscle contractions in the epididymides and vasa deferentia to actively transport spermatozoa to the



urethra, and the erectile and ejaculation efficiency to expel a sperm-rich ejaculate. The latter aspects are affected by sexual arousal – duration and quality – and effected through nerve signals to smooth muscle cells (vasa deferentia, glands, urinary bladder sphincter) as well as to smooth muscle cells controlling blood inflow of blood into and outflow from the erectile tissues of the penis, and the striated bulbocavernosus and perineal muscles.

- **The fluid volume contributed by the various accessory glands** reflects the secretory activity of the glands and the following smooth muscle contractions that empties each gland. These activities are responses to autonomous nerve stimulation elicited by sexual arousal and as preparation for ejaculation.

The nature of the spermatozoa (their vitality, motility and morphology) and the composition of the fluids of the ejaculate are also important for sperm function. There are, however, significant differences regarding sperm exposure to the ejaculatory fluids between the situation in vivo and that occurring in vitro.

As a result of sexual intercourse, the initial, sperm-rich prostatic fraction of the ejaculate is likely to come into contact with cervical mucus extending into the vagina (15) without any significant contact with the rest of the ejaculate. In contrast, in the laboratory setting, the entire ejaculate is collected in one container, where spermatozoa are trapped in a gel developed from proteins of seminal vesicular origin. In vitro, this gel is subsequently liquefied by the action of prostatic proteases, during which time its osmolality rises (13, 16-18).

There is some evidence that the total volume and the content of spermatozoa of ejaculates vary depending on the circumstances under which the ejaculate is produced. Ejaculates produced by masturbation and collected in containers in a room near the laboratory can result in lower yield than those recovered from non-spermicidal condoms used during intercourse at home (19). This difference may reflect a different level and duration of sexual arousal, since the time spent producing a sample by masturbation also influences the ejaculate volume and contents (20).

Under given conditions of collection, ejaculate characteristics depend on factors that usually cannot be modified, such as sperm production by the testes, accessory organ secretions and recent (particularly febrile) illness, as well as other factors, such as ejaculation abstinence, that should be recorded and considered in interpreting the results.

The results of laboratory measurements of ejaculate characteristics will depend on the following.

- Whether a complete ejaculate is collected. During ejaculation, the first fractions expelled are mainly sperm-rich prostatic fluids, whereas later fractions are dominated by seminal vesicular fluid (13). Therefore, losing the first (sperm-rich) portion of the ejaculate has more influence on the results of analysis than losing the last portion would have.
- The activity of the accessory sex glands, the fluids of which dilute the concentrated epididymal spermatozoa at ejaculation (21). Thus, sperm concentration is not a direct measure of testicular sperm output, as it is influenced by the secretion functioning of other organs. The total number of spermatozoa ejaculated (sperm concentration multiplied by semen volume) is therefore a better reflection of the capacity for sperm production (22). For example, sperm concentrations in



ejaculates from young and old men may be the same, but total sperm numbers may differ, as both the volume of seminal fluid and total sperm output decrease with age, at least in some populations (23).

- The time between the examined ejaculate and the most recent previous ejaculation (period of ejaculatory abstinence – “abstinence time”, sometimes less specifically referred to as sexual abstinence). Spermatozoa accumulate in the epididymides until they are full, then overflow into the urethra and are flushed out in urine (24, 25); As the epididymides are never completely emptied by one ejaculation (24), some spermatozoa remain from the time of the previous ejaculation. This influences the range of age and quality of spermatozoa in the ejaculate (26). Sperm vitality and chromatin are unaffected by increased length of abstinence (27, 28) unless epididymal function is disturbed (29). Furthermore, extensive studies to determine the daily production of spermatozoa have indicated that 2–3 days of daily ejaculations is necessary to deplete the epididymal storage of spermatozoa (30, 31). Thus, the recommendation, based on clinical experience, to ask men to collect the ejaculate to be examined after a period of 2–7 abstinence days can contribute to variability and an indistinct limit between normal and subfertile results. The extent of this influence is difficult to ascertain, and it is rarely considered.

Key patient factors influencing the ejaculate will include:

- The size of the testicles, which influences the total number of spermatozoa produced per day and thereby indirectly output per ejaculate (2, 32–34). Testicular size reflects the level of spermatogenic capacity, which is also related to sperm morphology (35).
- Endocrine status (36)
- Medications the man is taking. For instance, the transport of spermatozoa from the epididymides to the urethra depends on the activation of alpha-1 receptors in smooth muscle cells in the vasa deferentia. Treatment with alpha-blockers (anti-hypertensive drugs and symptomatic treatment of prostate hypertrophy) or selective serotonin reuptake inhibitor (SSRI) antidepressants (e.g. sertraline, fluoxetine, amitriptyline) can inhibit vas deferens motility (37) and also accessory sex gland emptying.
- Supplements or non-prescribed medications such as anabolic steroids.

These variable and largely uncontrollable factors contribute to the well-known variation in semen composition among individuals (38, 39).

There is evidence that the results of one single ejaculate examination are enough to decide subsequent steps of an infertility investigation of the man (9). On the other hand, to define an exact baseline for an individual, it can be necessary to examine two or three ejaculates (40–44).

While measurements made on the whole population of ejaculated spermatozoa cannot define the fertilizing capacity of the few that reach the site of fertilization, ejaculate analysis nevertheless provides essential information on the functional status of the reproductive organs of the individual. All aspects of ejaculate collection and examination must be assessed using properly standardized procedures if the results are to provide reliable – that is, valid and useful – information. The methods

described in this chapter are accepted procedures that constitute the essential steps in semen evaluation.

## 2.2 Temporal outline of basic semen examination

Basic semen examination involves the following steps (which are described in detail in subsequent sections) (45, 46).

### 2.2.1 Preparations – Pre-examination procedures

The pre-examination procedures comprise:

- patient information
- sample collection
- sample reception
- initial sample handling.

#### 2.2.1.1 In the first 5 minutes – Initial sample handling

For practical reasons it is convenient to determine sample volume by weighing during the pre-examination phase.

- Measuring semen volume by weight can preferably be done at the time the sample is received, and before liquefaction.
- Allow time for liquefaction to occur (usually no more than 30 minutes).

### 2.2.2 Examination procedures

The procedures for ejaculate examination are divided between assessment that cannot be delayed without risk of introduction of laboratory-induced abnormalities, and those that can be done later without such risk. This allows the laboratory to organize an efficient workflow without jeopardizing examination quality.

#### 2.2.2.1 Between 30 and 60 minutes after ejaculate collection

- Assess liquefaction and macroscopic appearance of the semen.
- Prepare a wet preparation for assessing microscopic appearance, sperm motility and the dilution required for assessing sperm concentration.
- Measure semen pH (if indicated).
- Assess sperm vitality (if the percentage of motile cells is low).
- Make dilutions for assessing sperm concentration.



- Make smears for assessing sperm morphology, and fixing smears.
- Perform the mixed antiglobulin reaction (MAR) test for anti-sperm antibodies (if required).
- Assess the presence of leukocytes cells (if required).
- Centrifuge semen aliquots (if biochemical markers are to be assayed).

### 2.2.2.2 Within 3 hours of ejaculate collection

- Determine sperm concentration (can be done later, preferably the same day).
- Send samples to the microbiology laboratory (if required).

### 2.2.2.3 Later, the same day or on a subsequent day

- Stain and assess smears for sperm morphology.
- Biochemical analysis of accessory gland markers (optional).

## 2.2.3 Post-examination procedures

- Calculations
- Results presentation
- Approval of results for release.

## 2.3 Pre-examination procedures

This section describes all necessary steps before the actual analyses can start.

### 2.3.1 Patient information

- The man should be given clear written and spoken instructions concerning the collection of the semen sample. The clinician should give the same information to the patient.
- The primary recommendation is ejaculate collection by masturbation.
  - Coitus interruptus is not recommended and should only be used in exceptional cases due to the risk of incomplete collection and contamination with vaginal fluid and cells.
  - Special condoms for fertility investigations may be an alternative under exceptional circumstances, but the entire ejaculate will not be available for examination, and the specimen is likely to be contaminated by contact with the skin of the penis and to some extent also vaginal fluid and cells on the outside of the condom. Contraceptive condoms cannot be used due to the

presence of spermicidal agents. Ordinary latex condoms must not be used for semen collection because they contain agents that interfere with the motility of spermatozoa (47).

- Lubricants should be avoided, since they may contaminate the ejaculate and change its properties. If absolutely necessary, validated non-spermatotoxic lubricants must be used.
- The ejaculate needs to be completely collected, and the man should report any loss of any fraction of the sample.
- The ejaculate should be collected after a minimum of 2 days and a maximum of 7 days of ejaculatory abstinence.
- To avoid exposure of the semen to fluctuations in temperature and to control the time between collection and analysis, it is recommended that the sample be collected in a private room close to the laboratory. Ideally, investigations should commence within 30 minutes after collection, but at least within 60 minutes.
  - Individual exceptions can of course be necessary, and each individual should be given proper advice on possibilities and risks.
  - If not collected in the proximity of the laboratory, transport must not allow the sample temperature to go below 20 °C or above 37 °C.
  - If the patient for any reason must collect the ejaculate at another place, the specimen container should be kept close to the body under the clothes – for instance, in the armpit – during transport and should be delivered to the laboratory preferably within 30 minutes after collection and at least no longer than 50 minutes after collection.

### 2.3.2 Sample collection

- Before ejaculate collection, the specimen container should be kept at ambient temperature, between 20 °C and 37 °C, to avoid large changes in temperature that may affect the spermatozoa.
- The specimen container should be a clean, wide-mouthed container made of plastic, from a batch that has been confirmed to be non-toxic for spermatozoa (**Section 2.5.10 on page 67**).
- The specimen container, as well as corresponding manual work sheets, must be labelled with identifiers that in combination with the procedures for sample reception and further handling eliminate the risk for mix-up of samples and work sheets. Legal requirements for container identity markers may differ. It could be the man's name and identification number, the date and time of collection, or unique sample identifying numbers.
- The following information should be recorded at sample reception and presented in the final report (**Section 8.5 on page 233**):
  - identity of the man (e.g. name, birth date and personal code number) and ideally his confirmation that the sample is his own;
  - the period of prior ejaculatory abstinence;
  - the date and time of collection;



- the completeness of the sample and any difficulties in producing the sample (e.g. if collection was not done at the laboratory); and
- ejaculate volume.
- Special conditions apply for some specific situations:
  - sterile collection for assisted reproduction or cryostorage (**Section 2.5.11 on page 68**)
  - sterile collection for microbiological analysis (**Section 2.5.12 on page 68**).

### 2.3.3 Initial sample handling

- The collected ejaculate should without unnecessary delay be allowed to liquefy, preferably in an incubator at 37 °C and, if possible, on an orbital mixing platform, to facilitate the liquefaction and mixing of the specimen.
- The time between collection and the start of the ejaculate examination should be recorded at the start of macroscopic evaluation and presented in the final report. Preferably assessment should start within 30 minutes after collection and no more than 60 minutes after collection.
- Prolonged in vitro exposure to the liquefied ejaculate fluid will affect qualities such as motility and morphology.
- Ejaculates may contain dangerous infectious agents (e.g. human immunodeficiency virus (HIV), hepatitis viruses or herpes simplex virus) and should therefore be handled as a biohazard. Safety guidelines as outlined in **Section 8.2 on page 214** should be strictly followed; good laboratory practice is fundamental to laboratory safety (48).

## 2.4 Examination and post-examination procedures

### 2.4.1 Assessment of ejaculate volume

Precise measurement of volume is essential in any evaluation of ejaculate because it gives information on the secretory functions of the auxiliary sex glands. A reliable ejaculate volume assessment is also necessary for the calculation of the total number of spermatozoa, the total number of non-sperm cells in the ejaculate, and the total amounts of biochemical markers.

#### 2.4.1.1 Volume by weight

The volume is best measured by weighing the sample in the container in which it has been collected. This can preferably be done at reception of the ejaculation container before incubation for liquefaction. Other methods introduce greater inaccuracy (Cooper et al., 2007).



1. Use a pre-weighed container for collection of the ejaculate, with the weight noted on the container and lid.
  - Empty specimen containers commonly have different weights, so each container with lid should be individually pre-weighed. The weight should be recorded on the container and its lid with a permanent marker pen before it is given to the patient. If labels are used – for example, for identity markers – their weight should be included in the empty weight. Sterile containers should not, and do not, require opening for this.
2. Weigh the vessel with the ejaculate in it.
3. Subtract the weight of the empty container.
4. Calculate the volume from the sample weight, assuming the density of semen to be 1 g/ml (Auger et al., 1995). (Semen density has been reported to vary between 1.03 and 1.04 g/ml (49), 1.00 and 1.01 g/ml (50), and an average of 1.01 g/ml (51)).

## 2.4.2 Macroscopic evaluation

Macroscopic evaluation comprises a number of important observations that may not be possible to assess in an exact numerical value – and thereby controlled by traditional quantitative methods – but can still be of great clinical importance.

### 2.4.2.1 Macroscopic appearance of the ejaculate

A normal liquefied ejaculate has a macroscopically homogeneous, cream/grey-opalescent appearance. It may appear less opaque if the sperm concentration is very low; the colour may also be different – i.e. slightly yellowish after longer abstinence times, red-brown when red blood cells are present (haemospermia), or clearer yellow in a patient with jaundice or taking certain vitamins or drugs. If the ejaculate appears viscous, totally clear and colourless, then it may be pre-ejaculate from only the Cowper's glands, which men produce in varying quantity during arousal; in this scenario this should be discussed with the patient to establish whether an orgasm-associated ejaculation occurred.

### 2.4.2.2 Liquefaction

Immediately after ejaculation into the collection vessel, the ejaculate is typically a semi-solid coagulated mass or a gel-like clump. Usually the ejaculate begins to liquefy (become thinner) within a few minutes at room temperature, at which time a heterogeneous mixture of semi-solid lumps will be seen in the fluid. As liquefaction continues, the ejaculate becomes more homogeneous and more watery but still with a higher viscosity than water. In the final stages of liquefaction only small areas of coagulation remain.

A temperature of 37 °C will facilitate liquefaction. Also, a slow, swirling movement of the sample container will help liquefaction to complete. If a moving tray (orbital mixer) is not used during liquefaction, it is essential that the container is slowly swirled for 15–30 seconds before starting the macroscopic assessment of liquefaction.



Complete ejaculate liquefaction is normally achieved within 15–30 minutes at room temperature.

- If liquefaction is not complete within 30 minutes, this should be recorded, and noted in the final report. The ejaculate could then be left in 37 °C for another 30 minutes.
- If liquefaction is not complete after 60 minutes, this should also be included in the final report.
- Normal liquefied ejaculates may contain a few jelly-like granules (gelatinous bodies) which do not liquefy and do not appear to have any clinical significance. The presence of mucus strands though may interfere with ejaculate examination and should therefore be noted in the final report.

Further information on **liquefaction problems** is provided in the last part of this chapter.

### 2.4.2.3 Ejaculate viscosity

After liquefaction, the viscosity of the ejaculate can be estimated by gently aspirating it into a wide-bore (approximately 1.5 mm diameter) plastic disposable pipette (verified as non-toxic to sperm and, if needed, sterile), allowing the semen to drop by gravity and observing the length of any thread.

A normal liquefied ejaculate falls as small discrete drops. If viscosity is abnormal, the drop will form a thread more than 2 cm long.

### 2.4.2.4 Ejaculate odour

There is considerable variability in the ability of different individuals to perceive the normal smell of a human ejaculate (45). Information of a strong odour of urine or putrefaction can be of clinical importance; it is therefore important to note this in the report.

### 2.4.2.5 Ejaculate pH

The pH at ejaculation depends on the relative contribution of acidic prostatic secretion and alkaline seminal vesicular secretion. In the ejaculate there is no efficient control of the pH of the fluid. In vitro, there will be a continuous loss of CO<sub>2</sub> that causes a gradual increase in pH. The clinical interest of ejaculate pH is a low value. If pH is to be assessed, it should be done at a uniform time, preferably 30 minutes after collection, but in any case, within 1 hour of ejaculation.

For normal samples, pH test strips in the range 6.0–10.0 should be used.

1. Mix the semen sample well.
2. Spread a drop of semen evenly onto the pH strip.
3. Wait for the colour of the impregnated zone to become uniform (< 30 seconds).
4. Compare the colour with the calibration strip to read the pH.



A pH value under 7.2 may be indicative of a lack of alkaline seminal vesicular fluid. It can also be due to urine contamination.

### 2.4.3 Preparation for microscopic investigation

For reliable results of microscopic investigation, it is essential that the aliquots examined are representative of the entire ejaculate. The nature of the liquefied ejaculate, which is still more viscous than water, makes taking a representative sample of semen for analysis highly problematic. If the sample is not well mixed, analysis of two separate aliquots is unlikely to be representative of the entire ejaculate and can show marked differences in sperm concentration, motility, vitality and morphology. Even if the liquefied ejaculate is macroscopically homogeneous, small aliquots can have very different composition.

#### 2.4.3.1 Ejaculate mixing

Before removing an aliquot of semen for any assessment, mix the sample well in the original container, but not so vigorously that air bubbles are created. Mixing can be achieved by placing the specimen container on a moving tray during liquefaction in a 37 °C incubator. In the absence of an orbital mixer, a basic mixing could be achieved by approximately 15–30 seconds of manual swirling (**Section 2.4.2.2 on page 16**).

#### 2.4.3.2 Representative sampling

Although liquefied ejaculates macroscopically may appear completely homogenous, there may still be small but significant compartments with different composition of sperm and secretions. It is therefore essential to:

- use replicate aliquots of at least 50 µl for dilution for sperm concentration assessment
- use replicate aliquots of at least 10 µl for sperm motility assessment.

The comparison of such replicate aliquots is necessary to reduce the risk of errors due to non-representative sampling. Methods for comparison are described under each assessment technique.

#### 2.4.3.3 Making a wet preparation

Directly after the ejaculate has been properly mixed (Section 2.4.3.1), remove the appropriate volume, allowing no time for the spermatozoa to settle out of suspension. Always remix the semen sample before removing replicate aliquots. Replicate motility assessments must be made on two different, freshly prepared wet preparations (see **Wet preparation principles on page 65** for background).

1. Place a 10 µl well-mixed aliquot onto a clean microscope slide that preferably is prewarmed to 37 °C (e.g. in the sample incubator).

- Take care to avoid the formation and trapping of air bubbles between the coverslip and the slide.





2. Place a 22 mm × 22 mm coverslip by dropping it carefully horizontally over the drop. The weight of the coverslip spreads the sample (so use a #1½ weight coverslip).
3. Assess the freshly made wet preparation as soon as the contents are no longer drifting.
  - If flow has not ceased within 1 minute after application of the coverslip, a new wet preparation must be made.

### 2.4.4 Assessment under the microscope

A light microscope equipped with phase-contrast optics is necessary for all examinations of unstained preparations of fresh semen (**Section 8.3 on page 221** for how to set up a microscope).

#### 2.4.4.1 Low magnification

An initial microscopic examination of the ejaculate aliquot involves scanning the preparation at a total magnification of ×100 (i.e. a combination of a ×10 objective lens with a ×10 ocular).

This provides an overview of the sample, to reveal if spermatozoa are evenly distributed in the preparation, any visible mucus strands, and sperm aggregation or agglutination. In case of uneven distribution, the reason could be:

- insufficient mixing
- high viscosity
- insufficient liquefaction
- sperm clumping.

#### 2.4.4.2 High magnification

The preparation should then be assessed at ×200 or ×400 total magnification (i.e. a combination of a ×20 or a ×40 objective with a ×10 ocular). This permits:

- assessment of sperm motility;
- determination of the dilution required for accurate assessment of sperm number (Section 2.4.4.3);
- determination of the presence of round cells that requires further assessment;
- determination of the presence of cells other than spermatozoa (e.g. epithelial cells) or "round cells" (leukocytes and immature germ cells).



### 2.4.4.3 Estimating appropriate dilution for sperm counting

The dilution of the ejaculate required to allow sperm concentration to be measured accurately is estimated from the number of spermatozoa observed in an entire high magnification microscopic field. At least 50 µl of well-mixed ejaculate should be used, and the total volume of sperm suspension should be at least 200 µl. The calculation of field area is described in **Section 2.5.9 on page 67**).

If no spermatozoa are observed, examine the replicate wet preparation. If no spermatozoa are found in the second preparation, proceed as in **Section 2.4.8.8 on page 35**. Table 2.1 has been developed to ensure the use of sufficient volumes of ejaculates and obtain final volumes of diluted sperm suspensions for adequate handling.

**Table 2.1 Sufficient volumes of ejaculates – final volumes of diluted sperm suspensions for adequate handling**

Spermatozoa per ×400 field	Spermatozoa per ×200 field	Dilution	Ejaculate (µl)	Fixative (µl)
> 200	> 800	1 : 50 (1 + 49)	50	2 450
40–200	160–800	1 : 20 (1 + 19)	50	950
16–40	64–160	1 : 10 (1+ 9)	50	450
2–15	8–64	1 : 5 (1 + 4)	50	200
< 2	< 8	1 : 2 (1 + 1)	100	100

#### 2.4.4.4 Fixative for diluting ejaculate aliquots

Prepare, for example, 1 litre of an aqueous solution containing 0.595 M sodium bicarbonate and approximately 0.14 M formalin (any liquid solution of formaldehyde is called formalin). The final concentration of formalin is one tenth of that used in pathology and cytology laboratories. Compared to the situation in such laboratories, the evaporation of formalin from counting chamber preparations is extremely low. Local regulations on handling of formalin must be followed, but handling in ventilation hoods is likely to be compulsory only for the preparation of the low concentration stock solution.

1. Dissolve 50 g of sodium bicarbonate (NaHCO<sub>3</sub>) in about 500 ml of distilled water, add 10 ml of 36–40% formaldehyde solution and add water up to 1000 ml final volume.
2. If desired, add 0.25 g of trypan blue (colour index 23859) or 5 ml of saturated (> 4 mg/ml) gentian violet (colour index 42555) to highlight the sperm heads and facilitate proper loading of the counting chambers.
3. Store at 2–8 °C for up to 12 months. If crystals form in the solution, pass it through a 0.45 µm filter before use.

#### 2.4.4.5 Dilution for the assessment of sperm number

Dilution with a fixative is necessary to immobilize spermatozoa. Immotile spermatozoa are much easier to count accurately than motile spermatozoa. Dilution is also important to create a specimen that is more aqueous for more reliable

loading into the haemocytometer. At least 50  $\mu\text{l}$  semen should be mixed with the diluent solution to ensure reliable representativity and sufficient suspension volume for thorough sample mixing (vortexing is possible after fixation). The appropriate dilution is estimated at the initial microscopic examination.

1. Use an air-displacement pipette to dispense the appropriate amount of fixative into two dilution vials.
2. Mix the semen sample carefully without making bubbles.
3. Use a positive displacement pipette to take an exact volume of semen for dilution.
4. Wipe the semen off the outside of the pipette tip, taking care not to touch the opening of the tip. Ascertain that there are no air bubbles in the pipette tip.
5. Dispense the semen into the fixative and rinse the pipette tip by aspirating and expressing the fixative. Remove the pipette tip with the plunger fully pressed and vortex the dilution immediately to reduce the risk of formation of visible precipitates that would make assessments unreliable.
6. Mix the semen sample well again and prepare the replicate dilution following the steps above.

#### 2.4.4.6 Assessment of sperm clumping

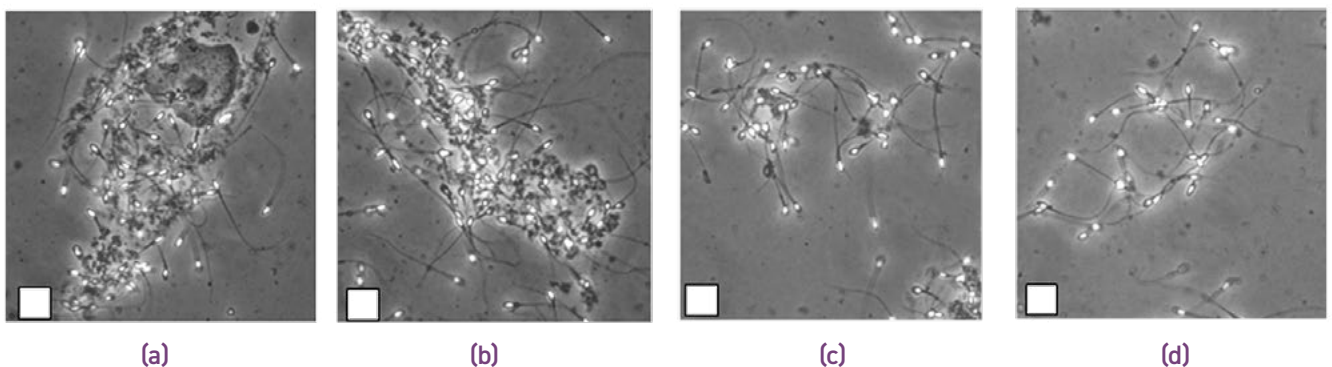
There are two different types of sperm clumping that it is essential to assess separately.

##### Sperm aggregates

The adherence either of immotile spermatozoa to each other or of motile spermatozoa to mucus strands, non-sperm cells or debris is defined as non-specific aggregation (Fig. 2.1).

**Fig. 2.1 Non-specific aggregation of spermatozoa in semen**

Views of spermatozoa aggregated with an epithelial cell (a), debris (b) or spermatozoa (c, d).



Micrographs courtesy of C. Brazil.

Sperm agglutinates

Agglutination specifically refers to motile spermatozoa sticking to each other, head-to-head, tail-to-tail or in a mixed way. The motility is often vigorous, with a frantic shaking motion, but sometimes the spermatozoa are so agglutinated that their motion is limited. Any motile spermatozoa that stick to each other by their heads, tails or mid-pieces should be noted. Motile spermatozoa stuck to cells or debris or immotile spermatozoa stuck to each other (aggregation) should not be scored as agglutination.

The major type of agglutination (reflecting the degree and the site of attachment should be recorded (52) (Fig. 2.2).

Fig. 2.2 Schematic diagram of different extents of sperm agglutination

Parts involved	Degree of agglutination			
	1. Isolated (< 10 sperm/agglutinate, many free sperm)	2. Moderate (10-50 sperm/agglutinate, free sperm)	3. Large (agglutinates >50 sperm, some sperm still free)	4. Gross (all sperm agglutinated, and agglutinates interconnected)
<b>A. Head-to-head</b>				
<b>B. Tail-to-tail heads are seen to be free and move clear off agglutinates</b>				
<b>C. Tail-tip-to-tail-tip</b>				
<b>D. Mixed (clear head-to-head and tail-to-tail agglutinates)</b>				
<b>E. Tangle (heads and tails enmeshed. Heads are not clear of agglutinates as they are in tail-to-tail agglutination)</b>				

Reprinted from Rose et al. (1976) with permission.

## 2.4.5 Cellular elements other than spermatozoa

The ejaculate contains cells other than spermatozoa, some of which may be clinically relevant. These include epithelial cells from the genitourinary tract, as well as leukocytes and immature germ cells, the latter two collectively referred to as “round cells” (53). It is, however, not possible to distinguish between leukocytes and immature germ cells with a high degree of certainty (54) by examining a stained smear at  $\times 1000$  magnification (see **Fig 2.16 on page 63**, **Fig 2.17 on page 70** and **Section 3.7 on page 119**). Further techniques for identifying active inflammatory cells are described in (**Section 3.5 on page 116**). The clinical value of these tests is not clear, so no evidence-based limits exist (55-57). See also **Section 2.4.8 on page 28**.

## 2.4.6 Sperm motility

The extent of progressive sperm motility is related to pregnancy rates (58-60). The total number of progressively motile spermatozoa in the ejaculate is of biological significance. This is obtained by multiplying the total number of spermatozoa in the ejaculate by the percentage of progressively motile cells. Methods of motility assessment involving computer-aided sperm analysis (CASA) are described in **Section 4.5.1 on page 155**.

If the liquefaction of the ejaculate is completed within 30 minutes, investigations should be started then. In case of incomplete liquefaction after 30 minutes, the ejaculate can be left in the 37 °C incubator for another 30 minutes, and then investigations should be started. Information on liquefaction delay or failure should be noted in the report.

The velocity of motile spermatozoa is temperature dependent. It is therefore essential to standardize the temperature during motility assessment. It is often easiest to control a temperature similar to body temperature, but that requires that the microscope is equipped with a temperature-controlled object stage, that microscope slides and coverslips are prewarmed, and that the sample is also warmed to 37 °C before assessment. These aspects are easily fulfilled when the sample liquefies in a 37 °C incubator. Using room temperature is more problematic, not least because room temperature is not defined and therefore can vary substantially.

The use of an eyepiece reticle with grid (**Fig. 2.3 on page 25**) is recommended to make it easy to limit the area assessed. This is very helpful in samples with high numbers of spermatozoa in each field.

- Always start scanning several fields without counting to get an impression of how well spread spermatozoa are. This can be done at lower magnification (100–200 $\times$  total magnification).
- Avoid assessing areas close (< 5 mm) to the edge of the coverslip to prevent drying artefacts affecting the motility assessment.
- Field choice should be random; avoid choosing fields based on the number of spermatozoa seen.
- Scan the slide systematically to avoid repeatedly viewing the same area. At least 5 different fields should be assessed, even if more than 200 spermatozoa have been counted in fewer than 5 fields.
- Start the scoring of a given field at a random instant (do not wait for spermatozoa to swim into the field or grid to begin scoring).



- Assess the motility of all spermatozoa within a defined area of the field. Select the portion of the field or grid to be scored depending on the sperm concentration – i.e. score only the top row of the grid if the sperm concentration is high; score the entire grid if the sperm concentration is low.
- Count systematically, starting with rapidly and slowly progressive spermatozoa to avoid overestimating the number of progressive spermatozoa. The goal is to count all progressively motile spermatozoa in the grid section instantly; avoid also counting those that swim into the grid section during scoring. In a second counting, non-progressive and immotile spermatozoa which remain within the grid section are counted.
- Assess approximately 200 spermatozoa per replicate; each replicate is a separate, fresh wet preparation.
  - If a count of 200 spermatozoa is achieved before all motility categories from one area have been scored, counting must continue beyond 200 spermatozoa until all categories have been counted, to avoid bias towards the motility category scored first.
- Compare the replicate values to check if they are acceptably close. If so, proceed with calculations; if not, prepare new samples. If three sets of replicates have failed to give acceptably close results, an average of all six assessments is given as the result, with a comment in the report that the result is the average of highly variable assessments (indicating the unusual uncertainty that could be the result of incongruous aliquots).
  - For troubleshooting motility assessments, see **Section 7.10.3 on page 207**.

#### 2.4.6.1 Categories of sperm movement

A four-category system for grading motility is recommended.

Clinical data from both manual assessment of sperm motility as well as computer-aided sperm analysis demonstrate that the identification of rapidly progressive spermatozoa is important (12, 61-70). Therefore, the recommended categories are (with approximate velocity limits):

- rapidly progressive ( $\geq 25 \mu\text{m/s}$ ) – spermatozoa moving actively, either linearly or in a large circle, covering a distance, from the starting point to the end point, of at least  $25 \mu\text{m}$  (or  $\frac{1}{2}$  tail length) in one second;
- slowly progressive ( $5 \text{ to } < 25 \mu\text{m/s}$ ) – spermatozoa moving actively, either linearly or in a large circle, covering a distance, from the starting point to the end point, of  $5 \text{ to } < 25 \mu\text{m}$  (or at least one head length to less than  $\frac{1}{2}$  tail length) in one second;
- non-progressive ( $< 5 \mu\text{m/s}$ ) – all other patterns of active tail movements with an absence of progression – i.e. swimming in small circles, the flagellar force displacing the head less than  $5 \mu\text{m}$  (one head length), from the starting point to the end point; and
- immotile – no active tail movements.

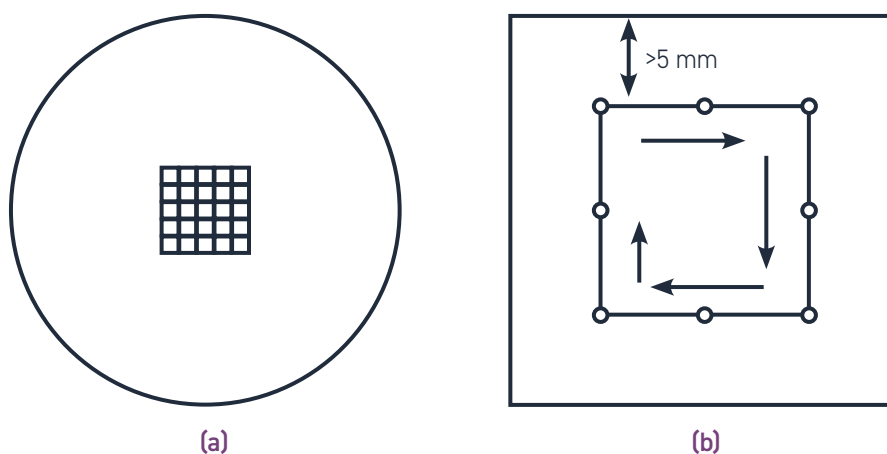


## 2.4.6.2 Comparison of replicates and calculation of results

- Calculate the proportions (%) of the four categories of motility for the two replicates separately, and the proportions of progressive and motile.
- Then calculate the average of the two replicates for the dominant group (immotile or motile).
- Calculate the difference between the replicates for the dominant group.
- Determine the acceptability of the difference from **Table 2.2 on page 26** (the maximum difference between two percentages that is expected to occur in 95% of samples because of random causes. If the difference is larger than the value in the table, it is less than 5% probability that the difference is due to random causes).
- If the difference between the percentages is acceptable, report the average percentage for each motility grade: (a) rapid progressive; (b) slow progressive; (c) non-progressive; (d) immotile. If the difference is too high, take two new aliquots from the semen sample, make two new preparations, and repeat the assessment. If replicates differ more than the acceptable difference, the assessment should not be repeated more than twice. A final result from the average of the six assessments can be given as the result, together with a comment that the result is uncertain due to high variability between replicate assessments.
- Report the average percentage for each motility grade to the nearest whole number.
- The sum of the four grades should be 100. If it is 99 or 101, the value of the dominant group is adjusted to give the sum of 100. If the sum is < 99 or > 101, a counting or calculation error must be eliminated.

Fig. 2.3 Aids to assessing sperm motility

(a) An eyepiece reticle makes it easier to count motile and immotile spermatozoa. (b) Systematic selection of fields for assessment of sperm motility, at least 5 mm from the edges of the coverslip.



**Table 2.2 Acceptable differences (based on 95% confidence interval) between two percentages for a given average, determined from replicate counts of 200 spermatozoa (total 400 counted)**

Average (%)	1	2-3	4-6	7-9	10-13	14-19	20-27	28-44	45-55	56-72	73-80	81-86	87-90	91-93	94-96	97-98	99
Acceptable difference	2	3	4	5	6	7	8	9	10	9	8	7	6	5	4	3	2

### 2.4.7 Sperm vitality

Sperm vitality, as estimated by assessing the membrane integrity of the cells, can be determined routinely on all ejaculates, but is not necessary when at least 40% of spermatozoa are motile. In samples with poor motility, the vitality test is important to discriminate between immotile dead sperm and immotile live sperm. The presence of a large proportion of live but immotile cells may be indicative of structural defects in the flagellum (71, 72); a high percentage of immotile and dead cells may indicate epididymal pathology (73, 74) or an immunological reaction due to an infection.

The percentage of live spermatozoa is assessed by identifying those with an intact cell membrane, by dye exclusion (dead cells have damaged plasma membranes that allow entry of membrane-impermeant stains) or by hypotonic swelling. The recommended test for diagnostic use is the eosin–nigrosin test. **Alternative vitality test** are described at the end of this section.

Sperm vitality should be assessed as soon as possible after liquefaction of the semen sample, preferably at 30 minutes, but in any case, within 1 hour of ejaculation, to limit deleterious effects of dehydration or changes in temperature on vitality.

#### 2.4.7.1 Vitality test using eosin–nigrosin

This one-step staining technique uses nigrosin to increase the contrast between the background and the sperm heads, which makes them easier to discern. It also permits slides to be stored for re-evaluation, training and quality control purposes (75, 76).

##### Preparing the reagents

1. Eosin Y: dissolve 0.67 g of eosin Y (colour index 45380) and 0.9 g of sodium chloride (NaCl) in 100 ml of purified water with gentle heating.
2. Eosin–nigrosin: add 10 g of nigrosin (colour index 50420) to the 100 ml of eosin Y solution.
3. Boil the suspension, then allow to cool to room temperature.
4. Filter through filter paper (e.g. 90 g/m<sup>2</sup>) to remove coarse and gelatinous precipitates, and store in a sealed dark glass bottle.

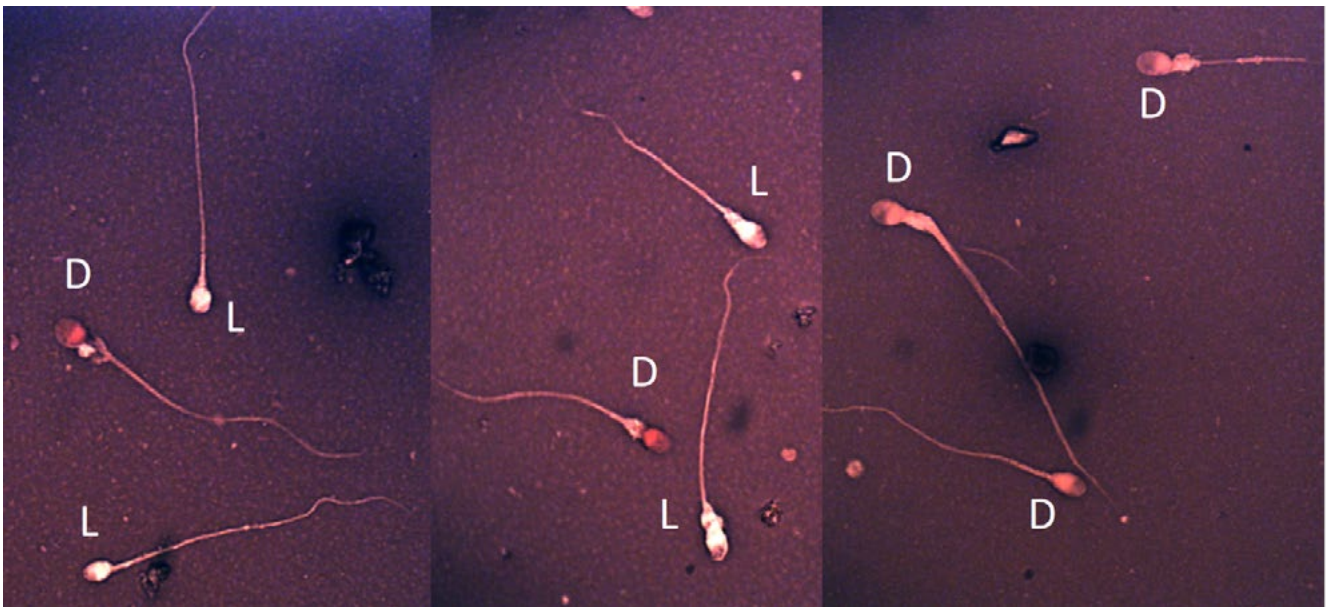


### Procedure

1. Mix the semen sample well.
2. Remove a 50- $\mu$ l aliquot of semen, mix with an equal volume of eosin–nigrosin suspension (e.g. in a porcelain spotting plate well or test tube), and wait for 30 seconds.
3. Make a smear on a glass slide and allow it to dry in air.
4. Examine immediately after drying (with risk of nigrosin contamination of the objective), or later after mounting with a permanent non-aqueous mounting medium.
5. Examine the slide with brightfield optics at  $\times 1000$  magnification and oil immersion.
6. Tally the number of stained (dead) or unstained (live) cells with the aid of a laboratory counter.
7. Evaluate at least 200 spermatozoa, to achieve an acceptably low sampling error (77).
8. For troubleshooting vitality assessments, see **Section 7.10.4 on page 208**.

**Fig. 2.4 Eosin–nigrosin smear observed in brightfield optics**

Spermatozoa with red or dark pink heads are considered dead (D), whereas spermatozoa with white heads (L) are considered alive.



Micrograph courtesy of L. Björndahl.

### Scoring

1. The nigrosin provides a dark background, which makes it easier to discern faintly stained spermatozoa.
2. With brightfield optics, live spermatozoa have white heads, and dead spermatozoa have heads that are stained red or pink. Spermatozoa with a faint pink head staining are assessed as dead.

- If the stain is limited to only a part of the neck region, and the rest of the head area is unstained, this is considered a “leaky neck membrane”, not a sign of cell death and total membrane disintegration. These cells should be assessed as live.

### 2.4.7.2 Calculations

- Calculate the percentage of live cells.
- Report the percentage of vital spermatozoa, rounded off to the nearest whole number.

### 2.4.7.3 Interpretation of vitality results

The clinically interesting information is in samples with few or no motile spermatozoa.

- Determine the proportion spermatozoa that are live and immotile.
  - Subtract the motile proportion (sum of rapid, slow and non-progressive) from the live proportion.
  - Is the proportion of live, immotile spermatozoa more than 25–30% of all spermatozoa?
 

There is no exact limit, but if more than 25–30% of all spermatozoa are alive and immotile, a genetic ciliary problem may be the cause, and therefore sperm motility is not likely to be possible to improve by any medical treatment.

## 2.4.8 Counting spermatozoa and other cells

The total number of spermatozoa per ejaculate and the sperm concentration are related to both time to pregnancy (78) and pregnancy rates (59, 79), and are predictors of conception (60, 80). However, more data correlating total sperm numbers with reproductive outcome are warranted.

The number of spermatozoa in the ejaculate is calculated from the concentration of spermatozoa and the ejaculate volume. For normal ejaculates, when the male tract is unobstructed and the abstinence time short, the number of spermatozoa is correlated with testicular volume (2, 32, 34, 81) and thus is a measure of the capacity of the testes to produce spermatozoa (82), the patency of the male tract and, potentially, the number of spermatozoa transferred to the female during coitus.

The concentration of spermatozoa in the ejaculate, while related to fertilization and pregnancy rates, is influenced by the volume of the secretions from the seminal vesicles and prostate (83) and is not a good measure of testicular function.

The term “sperm density” (mass per unit volume) must not be used when sperm concentration (number per unit volume) is meant.



### 2.4.8.1 Overview of sperm counting

- Choose the most appropriate dilution from examination of the wet preparation (**Section 2.4.4.3 on page 20**).
- Prepare dilutions by mixing exact volumes of ejaculate and fixative (**Table 2.1 on page 20**; **Section 2.4.4.3 on page 20**).
  - If a 50 µl semen aliquot is taken with a positive displacement pipette and diluted properly, only one dilution needs to be made (84, 85). Replicate aliquots from the sperm suspension need to be examined and compared.
- Prepare the counting chamber (haemocytometer).
- Load the haemocytometer chamber and leave it in a humid chamber to allow the spermatozoa to settle onto the bottom of the counting chamber.
- Assess the sperm numbers promptly after removal from the humid chamber (to avoid negative effects of evaporation from the counting chamber).
- Count at least 200 spermatozoa per replicate.
- Compare replicate counts to see if they are acceptably close. If so, proceed with calculations; if not, prepare new dilutions.
  - For troubleshooting sperm counting issues, see **Table 7.14 on page 208**.
- Calculate the concentration in spermatozoa per ml.
- Calculate the number of spermatozoa per ejaculate.

### 2.4.8.2 The haemocytometer with improved Neubauer ruling

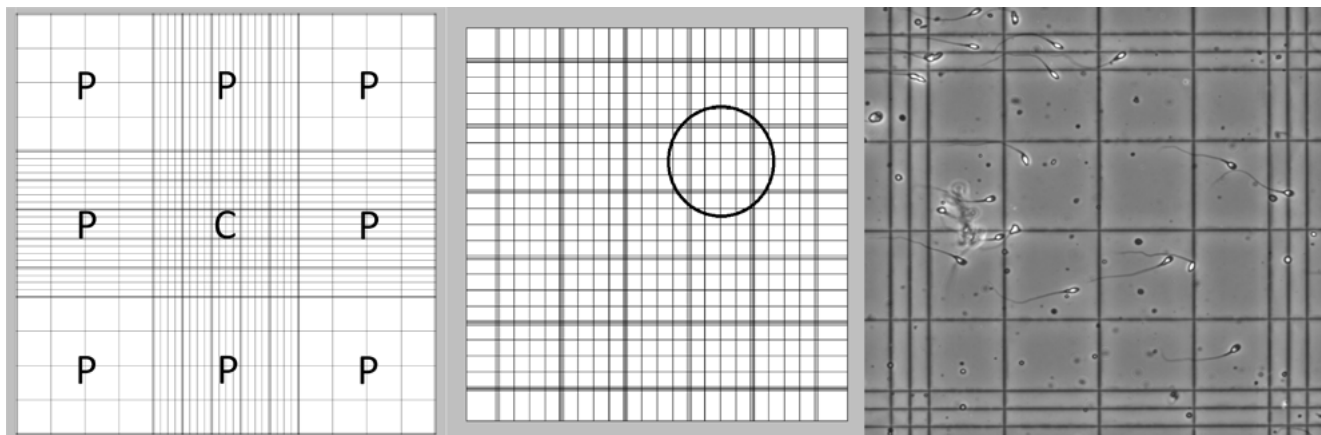
The use of haemocytometer chambers with improved Neubauer ruling is recommended. Dilution factors for the improved Neubauer haemocytometer chamber are given in **Section 2.4.4.3 on page 20**. Other haemocytometer chambers may be used, but if they have different grid patterns and areas, other calculation factors are required. Disposable haemocytometers with Neubauer ruling must be validated (86).

The improved Neubauer haemocytometer has two separate counting chambers, each of which has a microscopic 3 mm × 3 mm pattern of gridlines etched on the glass surface. It is used with a special, thick coverslip (thickness #4, 0.44 mm), which lies over the grids and is supported by glass pillars 0.1 mm (100 µm) above the chamber floor. Each counting area is divided into nine 1 mm × 1 mm grids. These grids will be referred to by the numbers shown in Fig. 2.5.

Depending on the dilution and the number of spermatozoa counted, different areas of the chamber are used for determining sperm concentration. In general, the central grid is used for counting. The eight peripheral grids are used when fewer than 200 spermatozoa have been counted in the central grid.

**Fig. 2.5 The haemocytometer with improved Neubauer ruling**

Illustration of the inscribed area showing: all nine grids in one chamber of the haemocytometer (*left panel*), the central grid (C) and eight peripheral grids (P). The central grid consists of 25 large squares (*middle panel*); and a micrograph of part of a filled chamber (*right panel*), showing one of the 25 squares of the central grid (the circled square in the middle panel) bounded by triple lines and containing 16 smaller squares. The eight peripheral grids have the same size as the central grid, but the sizes and numbers of the smaller rectangles vary. With a depth of 100  $\mu\text{m}$ , each of the nine grids holds 100 nL.



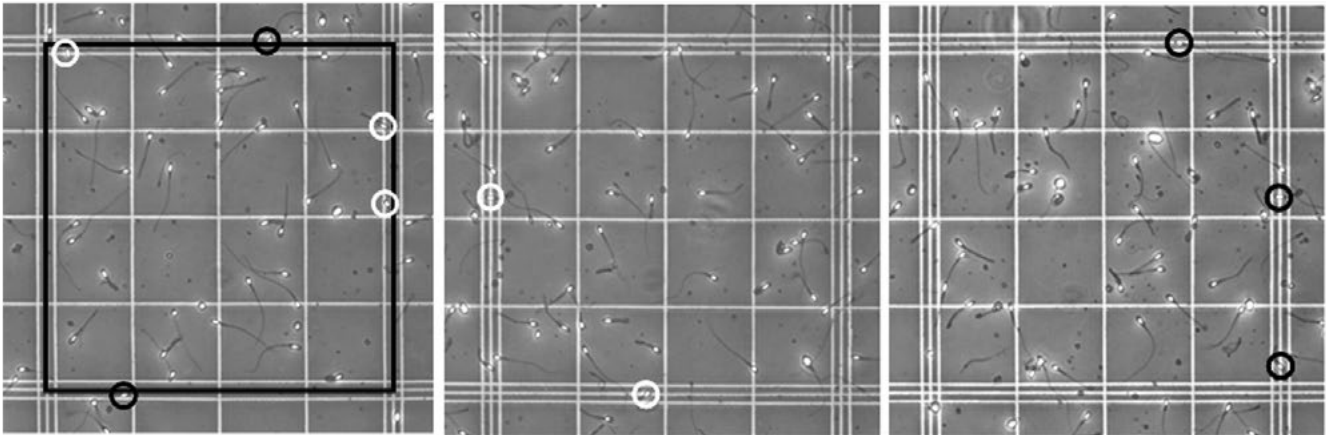
Graphics and micrograph courtesy of L. Björndahl.

#### Principles for counting in a haemocytometer grid

- Count only whole spermatozoa (with a head and a tail).
  - If there are many headless sperm tails (so-called “pinhead” spermatozoa) or heads without tails, their presence should be recorded in the report. The concentration can be estimated in relation to whole spermatozoa (for instance, “45 headless tails per 100 spermatozoa”).
  - If sperm heads with more than one tail are more than one in five (20 per 100 counted spermatozoa), the relative frequency should be reported.
- The boundary of a large square is indicated by the middle line of the three.
- Whether or not a spermatozoon is counted is determined by the location of its head; the orientation of its tail is unimportant.
  - All spermatozoa without contact with the boundaries (middle of triple line) of a large square are counted (Fig. 2.6 left panel: white circles – counted)
  - Only spermatozoa in contact with the lower or left boundaries are counted; not those in contact with the upper or right boundaries (Fig. 2.6 middle panel: white circles – counted; right panel: black circles – counted).

**Fig. 2.6 Which spermatozoa to count in the grid squares**

The middle of the three lines defines the square's boundary (*black line, left panel*). All spermatozoa within the central square are counted (*white circles*). A spermatozoon with its head on the middle line is counted only if that line is the lower or left boundary of the square (*white circles, middle panel*), but not if it is the upper or right-hand line of the square (*black circles, right panel*).



Micrographs courtesy of C. Brazil.

#### 2.4.8.3 Preparing and loading the haemocytometer chambers

1. Make the haemocytometer coverslip attachment surface ("chamber pillars") slightly damp.
2. Secure the coverslip on the counting chambers by pressing it firmly onto the chamber pillars. Iridescence (multiple Newton's rings) between the two glass surfaces confirms the correct positioning of the coverslip. The more lines, the better the fit; only one or two lines indicates that glass surfaces are not close enough and will cause incorrect chamber depth. Ensure that the coverslip is securely attached and will not move by gentle touch with a pipette tip.
3. Mix the first dilution thoroughly by vortexing for 15 seconds at high speed. To avoid sedimentation of the spermatozoa, immediately remove a volume of the fixed suspension sufficient to fill the entire area under the coverslip over one counting chamber (typically approximately 10  $\mu$ l).
4. Touch the pipette tip carefully against the edge of the coverslip of one of the chambers.
5. Depress the plunger of the pipette slowly, allowing the chamber to fill by capillary action. The coverslip should not be moved during filling, and the chamber should not be overfilled or underfilled (when air occupies some of the chamber area).
6. Mix the second dilution, as above, and immediately remove a second aliquot. Load the second chamber of the haemocytometer following the steps above.
7. Store the haemocytometer horizontally for at least 10–15 minutes (to allow complete sedimentation of spermatozoa in the 100  $\mu$ m deep chamber) at room temperature in a humid chamber (e.g. on water-saturated filter paper in a covered Petri dish) to prevent drying out.

#### 2.4.8.4 Assessing sperm number in the counting chambers

Sperm number should be assessed in both chambers of the haemocytometer. If the two values agree sufficiently, the aliquots taken can be considered representative of the sample (**Section 2.4.3.2 on page 18**). It is important to remember that the absence of spermatozoa from the aliquot examined does not necessarily mean that they are absent from the rest of the ejaculate.

1. Examine the haemocytometer with phase contrast optics at  $\times 200$  magnification (or  $\times 400$  if microscope optics allow).
2. The aim is to count at least 200 spermatozoa in each replicate, to achieve an acceptably low sampling error.
3. First assess the upper left large square in the central grid of one side of the improved Neubauer chamber. Use this number to decide how many large squares of the central grid to assess:
  - $< 10$  spermatozoa: count the whole grid (25 large squares)
  - 10–40 spermatozoa: count 10 large squares
  - $> 40$  spermatozoa: count 5 squares (e.g. 4 corners and centre).



**Note:** If fewer than 200 spermatozoa are counted in the predetermined number of large squares, extend the counting to the next larger number of large squares above. If all 25 large squares in the central grid have been assessed without reaching 200 spermatozoa, consider counting also 1–8 of the peripheral grids (Fig 2.5).

4. Make a note of the number of large squares or grids assessed to reach at least 200 spermatozoa. The same number of large squares or grids must be counted from the other chamber of the haemocytometer.
5. Tally the number of spermatozoa with the aid of a laboratory counter.
6. Switch to the second chamber of the haemocytometer and perform the replicate count on the same number of squares or grids as the first replicate, even if this yields fewer than 200 spermatozoa.
7. Calculate the sum and difference of the two numbers.
8. Determine whether the difference between the replicate counts is acceptable from Section 2.4.8.5.
  - If the difference is acceptable, calculate the concentration (**Section 2.4.8.6 on page 34**) and total number of spermatozoa per ejaculate (**Section 2.4.8.7 on page 35**).
  - If the difference is too high:
    - First load a new haemocytometer from the replicate dilutions and count. If the difference is still too high, count a third time.
    - If the difference is still too high after three counts of replicates, the average from all accounts is calculated, and a comment on the increased uncertainty of the result given in the final report.



### 2.4.8.5 Comparison of difference between replicate counts

Find the row containing your sum of counted spermatozoa in the column with the range of sums. If your found difference between replicate counts is less than or equal to the limit for difference in the column to the right of the range of sums, you can accept the replicate assessments and calculate the final result.

The third column gives an indication of the uncertainty of the final result based on the number of observations (number of assessed spermatozoa). With few observations, replicate counts can be accepted with a smaller difference, but the final result is still less certain due to the limited number of observations (see **Section 8.6 on page 234**).

**Table 2.3 Comparison of difference between replicate counts and relation to uncertainty of result**

Range of sums	Limit difference	Error of final result based on number of observations
969-1000	61	3.2%
938-968	60	3.3%
907-937	59	3.3%
876-906	58	3.4%
846-875	57	3.4%
817-845	56	3.5%
788-816	55	3.6%
760-787	54	3.6%
732-759	53	3.7%
704-731	52	3.8%
678-703	51	3.8%
651-677	50	3.9%
625-650	49	4.0%
600-624	48	4.1%
576-599	47	4.2%
551-575	46	4.3%
528-550	45	4.4%
504-527	44	4.5%
482-503	43	4.6%
460-481	42	4.7%
438-459	41	4.8%
417-437	40	4.9%
396-416	39	5.0%
376-395	38	5.2%
357-375	37	5.3%
338-356	36	5.4%
319-337	35	5.6%

Range of sums	Limit difference	Error of final result based on number of observations
301–318	34	5.8%
284–300	33	5.9%
267–283	32	6.1%
251–266	31	6.3%
235–250	30	6.5%
219–234	29	6.8%
206–218	28	7.0%
190–205	27	7.3%
176–189	26	7.5%
163–175	25	7.8%
150–162	24	8.2%
138–149	23	8.5%
126–137	22	8.9%
115–125	21	9.3%
105–114	20	9.8%
94–104	19	10.3%
85–93	18	10.8%
76–84	17	11.5%
67–75	16	12.2%
59–66	15	13.0%
52–58	14	13.9%
44–51	13	15.1%
38–43	12	16.2%
32–37	11	17.7%
27–31	10	19.2%
22–36	9	21.3%
17–21	8	24.3%
13–16	7	27.7%
10–12	6	31.6%
7–9	5	37.8%
5–6	4	44.7%
3–4	3	57.7%
2	2	70.7%
1	1	100.0%

#### 2.4.8.6 Calculation of sperm concentration from sperm count

The sum of the two accepted replicate counts is divided by a factor that is determined by the dilution and number of large squares or grids assessed in both counting chambers (if three attempts have been done without reaching sufficient agreement between replicate counts, the average of the three sums is used).





Table 2.4 Calculation of sperm concentration from sperm count

Dilution	Number of <i>large squares</i> counted in each chamber			Number of <i>grids</i> counted in each chamber							
	5	10	25	2	3	4	5	6	7	8	9
	Correction factor values										
1 : 2	20	40	100	200	300	400	500	600	700	800	900
1 : 5	8	16	40	80	120	160	200	240	280	320	360
1 : 10	4	8	20	40	60	80	100	120	140	160	180
1 : 20	2	4	10	20	30	40	50	60	70	80	90
1 : 50	0.8	1.6	4	8	12	16	20	24	28	32	36



**Note:** A haemocytometer with *improved Neubauer ruling* has two counting chambers. Each counting chamber consists of nine (3×3) grids of equal size. The central *grid* consists of 25 *large squares*, each surrounded by a triplet line, while the 8 peripheral fields each consist of 16–20 rectangles.

If fewer than 25 spermatozoa are counted in each chamber, the concentration will be < 55 555 spermatozoa/ml if a 1+1 (1 : 2) dilution is used (87). The estimated error of the result is over 14% (Table 2.3) (with higher dilution, the concentration result will be higher but with the same high estimated error, > 14%). Report the number of spermatozoa observed with the comment “Too few spermatozoa counted for accurate determination of concentration (< 56 000/ml)”. See also **Section 2.4.8.8** below when accurate assessment of low sperm number is required.

#### 2.4.8.7 Calculation of total number of spermatozoa

- It is essential to calculate and report the total number of spermatozoa per ejaculate, as this parameter provides a much better measure of testicular sperm production and of the number of spermatozoa transferred to the female during coitus. This is obtained by multiplying the sperm concentration by the volume of the whole ejaculate.
- The total sperm number should be reported as an integer number (no decimal places) of millions of spermatozoa, with exception only for numbers below 10 million, where one decimal place may be acceptable for the sake of clarity in the lower range of results, although the analytical variability does justify the use of a decimal place.

#### 2.4.8.8 Low sperm numbers

If no spermatozoa are observed in the replicate wet preparations, a total lack of spermatozoa (azoospermia) can be suspected. Although it has been suggested that the definition should change (88, 89), azoospermia remains a description of findings in the ejaculate and not a diagnosis or a basis for therapy. It is generally accepted that the term azoospermia can only be used if no spermatozoa are found in the sediment of a centrifuged sample (90).



However, it should be borne in mind that:

- whether or not spermatozoa are found in the pellet depends on the centrifugation time and speed (91, 92) and on how much of the pellet is examined;
- centrifugation at 3000g for 15 minutes does not pellet all spermatozoa from a sample (93); and
- after centrifugation, motility can be lost (46), and concentration will be underestimated (87); if counts have been done on a centrifuged sample, this should be clearly stated in the final report.

The way these samples are handled depends on whether qualitative data on the presence and motility of spermatozoa are sufficient or if accurate numbers of spermatozoa are needed (see **Examination of non-centrifuged ejaculates to detect motile spermatozoa** below and **Examination of centrifuged samples to detect spermatozoa irrespective of motility on page 41**) when assessment of low sperm numbers is required.

Although rough estimates of low sperm concentrations can be obtained using a 1+1 (1 : 2) dilution if all nine grids are examined, the estimated error is high. Furthermore, analysis of ejaculates diluted so little can show a large amount of background under microscopy. Scanning large chambers can take 10–20 minutes, but rapid detection of spermatozoa can be facilitated by use of a fluorescent dye (87). It must be noted that values obtained by the methods below should be considered an estimate because so few spermatozoa are counted, and the volumes may be inaccurate.

#### Examination of non-centrifuged ejaculates to detect motile spermatozoa

When detection of motile spermatozoa is essential, it is important to determine whether centrifugation procedures used can damage sperm and impair sperm motility and therefore cause false results. If centrifuged samples are used, the laboratory must ensure that their procedures do not harm sperm motility or fertilizing ability.

#### Estimation of concentration by scanning wet preparations

1. Use two consecutive wet preparations (**Section 2.4.3.3 on page 18**).
2. Scan the entire coverslip systematically field by field. Start in one corner and scan along the x-axis to the opposite side; then move one field along the y-axis and scan back along the entire width. Continue in this zig-zag fashion to make a complete and systematic search of the entire aliquot (Fig. 2.7). Keep observing the slide while changing fields.
  - With a ×20 objective and ×10 ocular of 20 mm aperture, the microscope field has a diameter of approximately 1000 µm (**Section 2.5.9 on page 67**). There will thus be approximately 484 fields per 22 mm × 22 mm coverslip to be examined.
3. From the number of observed motile and immotile spermatozoa in 10 µl or 20 µl, an approximate concentration can be calculated by multiplying the total ejaculate volume by the number of spermatozoa observed and a factor:
 
$$N = \text{observed number of spermatozoa}$$

$$\text{Vol} = \text{ejaculate volume (ml)}$$

$$\text{Factor (100 for 10 µl examined, 50 for 20 µl examined)}$$

$$\text{Concentration (sperm/ml)} = N \times \text{Vol} \times \text{factor}$$

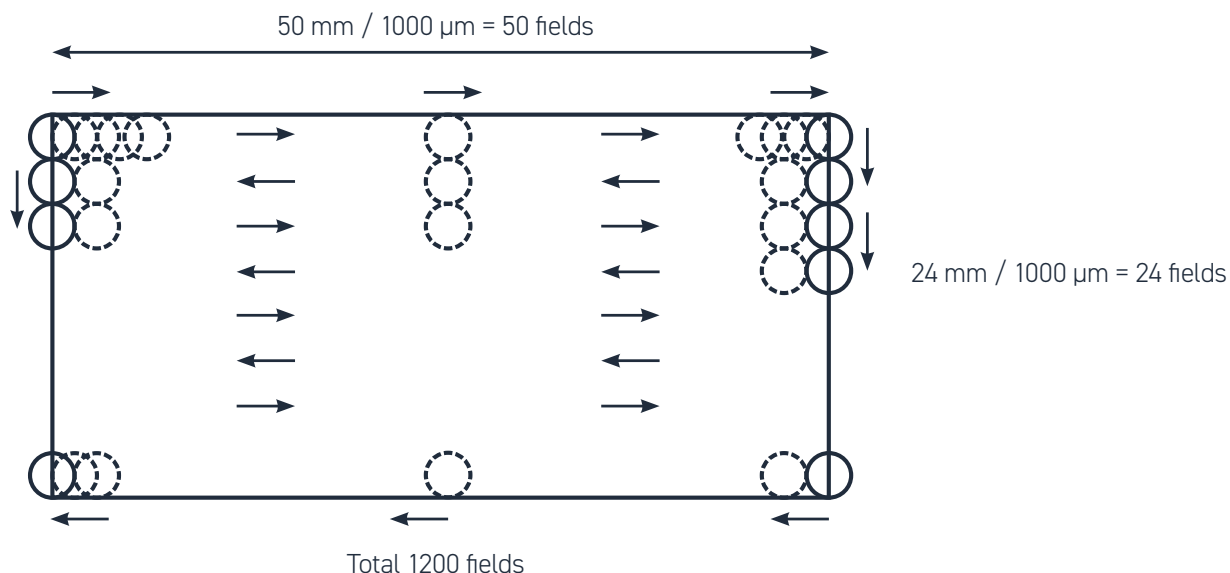


4. The report must state that it is an approximation and not an exact value.

5. For calculations of probabilities of sperm presence despite scanning of wet preparations, see **Section 2.5 on page 64**.

**Fig. 2.7 Scanning the entire coverslip for the presence of motile spermatozoa**

This involves assessing high-power microscopic fields at  $\times 200$  magnification for a 22 mm  $\times$  22 mm coverslip.



#### *Estimation of concentration based on HPF observations*

If there are fewer than four spermatozoa per  $\times 400$  HPF (i.e. approximately less than  $1 \times 10^6$ /ml), for men with male subfertility it may be sufficient to report that the estimated sperm concentration is about  $1 \times 10^6$ /ml, with a note in the report indicating clearly that this is only a very rough estimated sperm concentration and whether motile spermatozoa were seen. This imprecise estimation should only be done when the purpose of assessment of sperm concentration is for deciding the further clinical investigation or for deciding the optimal modality of assisted reproductive technologies (ART) for the couple. This estimation should not be used for routine semen analysis, in particular for monitoring effects of potential male contraceptive agents and response to endocrine stimulation of spermatogenesis. When counting very low sperm concentration or total number of sperm per ejaculate matters, count all nine large squares as described in **Section 2.4.8.4 on page 32**.

#### *Assessing low sperm numbers in large-volume disposable chambers*

The use of large-volume, 100  $\mu$ m-deep chambers can increase the sensitivity of the concentration assessment (85). The large-volume chamber has two 100- $\mu$ m deep chambers, each holding 25  $\mu$ l. To reduce sampling errors, a critical number of spermatozoa (preferably a total of at least 400 from replicate counts of approximately 200) have to be counted (**Table 2.16 on page 78**).

1. Mix the semen sample well.

2. Remove an aliquot of semen, if low sperm numbers are expected then dilution may not be necessary and allows for motile sperm to be easily observed. If diluting, dilute 1+1 (1 : 2) with fixative (**Section 2.4.4.4 on page 20**).

The dilution 1+1 (1 : 2) for samples with fewer than 2 spermatozoa at the initial evaluation (**Table 2.1 on page 20**) is appropriate for a range of sperm concentrations, yielding about 200 spermatozoa within the entire chamber.

- If fluorescence is available on the microscope, then staining "diluted" fixed sperm with an appropriate dye, such as DAPI can aid their identification.

#### *Achieving 200 spermatozoa per replicate in a large-volume disposable chamber*

- If there is only one spermatozoon per HPF of 4 nl in the initial wet preparation, there is theoretically 0.25 spermatozoa per nl (250/μl or 250 000/ml).
- The large-volume chamber holds 25 μl, so there would be 6 250 spermatozoa within it. Diluting the sample 1+1 (1 : 2) would reduce the background and the sperm number to 3 125 per chamber, sufficient for an acceptably low sampling error.
- However, this value can only be a rough estimate because so few spermatozoa are counted, and the volumes may be inaccurate.

#### *Procedure*

- Take the relevant sample as above (diluted or neat).
- Fill each chamber of the slide with 25 μl of the fluid.
- Store the chamber horizontally for 10–15 minutes at room temperature in a humid chamber (e.g. on water-saturated filter paper in a covered Petri dish) to prevent drying out. (If using fluorescence the dye will bind to the sperm heads and the immobilized cells sediment on the chamber floor during this time).
- Examine the slide at ×250 magnification.
- Count at least 200 spermatozoa in each replicate, to achieve an acceptably low sampling error (**Table 2.16 on page 78**).
- Examine one chamber systematically field by field. Start in one corner and scan along the x-axis to the opposite side; then move one field along the y-axis and scan back along the entire width. Continue in this zig-zag fashion. Keep observing the slide while changing fields. Continue counting until at least 200 spermatozoa have been observed.
- Make a note of the number of fields assessed to reach at least 200 spermatozoa. The same number of fields will be counted from the other chamber.
- Tally the number of spermatozoa and fields with the aid of a laboratory counter.
- Switch to the second chamber and perform the replicate count on the same number of fields (the same volume) as the first replicate, even if this yields fewer than 200 spermatozoa.
- Calculate the sum and difference of the two numbers.
- Determine the acceptability of the difference from **Table 2.3 on page 33** – the maximum difference between two counts that is expected to occur in 95% of samples because of sampling error alone.

12. If the difference is acceptable, calculate the concentration. If the difference is too high, make two new preparations and repeat the assessment.

13. Report the average sperm concentration to two significant figures.

14. Multiply the sperm concentration by the semen volume (ml) to obtain the total number of spermatozoa per ejaculate.

#### *Calculation of low sperm concentrations by field examined*

The concentration of spermatozoa in semen is their number (N), divided by the volume of the total number (n) of microscopic fields examined (where the volume (v) of a field is calculated as in **Section 2.5.9 on page 67**), multiplied by the dilution. That is,  $C = (N/n) \times (1/v) \times \text{dilution factor}$ .

At total  $\times 250$  magnification, the field volume is 80 nl (Section 2.5.9), and for a 1+1 (1 : 2) dilution, the concentration is:

$$C = (N/n) \times (1/80) \times 2 \text{ spermatozoa/nl} = (N/n) \times (1/40) \text{ spermatozoa/nl (million spermatozoa/ml of semen).}$$

At total  $\times 400$  magnification, the field volume is 20 nl (Section 2.5.9), and for a 1+1 (1 : 2) dilution, the concentration is:

$$C = (N/n) \times (1/20) \times 2 \text{ spermatozoa/nl} = (N/n) \times (1/10) \text{ spermatozoa/nl (million spermatozoa/ml of semen).}$$

When the entire area of both chambers has been assessed, the total number of spermatozoa is divided by the total volume of both chambers (50  $\mu\text{l}$ ), multiplied by the dilution factor (2), to obtain the concentration in spermatozoa/ $\mu\text{l}$  (thousands/ml of semen).

If the sample has not been diluted the dilution factor is 1.

#### *Volume observed per high-power field in a 100- $\mu\text{m}$ -deep, large-volume disposable chamber*

- The volume of semen in each microscopic field depends on the area of the field ( $\pi r^2$ , where  $\pi$  is approximately 3.142 and  $r$  is the radius of the microscopic field) and the depth of the chamber (here 100  $\mu\text{m}$ ).
- The diameter of the microscopic field can be measured with a stage micrometer or can be estimated by dividing the diameter of the aperture of the ocular lens by the magnification of the objective lens.
- With a  $\times 40$  objective and a  $\times 10$  ocular of aperture 20 mm, the microscope field has a diameter of approximately 500  $\mu\text{m}$  (20 mm/40). In this case,  $r = 250 \mu\text{m}$ ,  $r^2 = 62\,500 \mu\text{m}^2$ ,  $\pi r^2 = 196\,375 \mu\text{m}^2$ , and the volume is 19 637 500  $\mu\text{m}^3$  or about 20 nl.
- With a  $\times 25$  objective and a  $\times 10$  ocular of aperture 25 mm, the microscope field has a diameter of approximately 1000  $\mu\text{m}$  (25 mm/25). In this case,  $r = 500 \mu\text{m}$ ,  $r^2 = 250\,000 \mu\text{m}^2$ ,  $\pi r^2 = 785\,500 \mu\text{m}^2$ , and the volume is 78 550 000  $\mu\text{m}^3$  or about 80 nl.

*Sensitivity of the method*

If there are fewer than 200 spermatozoa in each chamber, the sampling error will exceed 5%. When fewer than 400 spermatozoa are found in both chambers, report the sampling error for the number of cells counted.

If fewer than 25 spermatozoa are counted in each chamber, the concentration will be < 2000 spermatozoa/ml, with an estimated error of > 14%. Report the number of spermatozoa observed with the comment "Too few spermatozoa counted for accurate determination of concentration (< 2000/ml)".

It is important to note that the absence of spermatozoa from the aliquot examined does not necessarily mean that they are absent from the rest of the sample.

*Worked examples**Example 1*

With a 1+1 (1 : 2) dilution, replicate 1 is found to contain 210 spermatozoa in 300 fields, while replicate 2 contains 300 spermatozoa in 300 fields. The sum of the values (210+300) is 510 in 600 fields, and the difference (300–210) is 90. From **Table 2.3 on page 33** this is seen to exceed the difference expected by chance alone (44), so the results are discarded, and two new replicate dilutions are made.

*Example 2*

With a 1+1 (1 : 2) dilution, replicate 1 is found to contain 200 spermatozoa in 400 fields, while replicate 2 contains 230 spermatozoa in 400 fields. The sum of the values (200+230) is 430 in 800 fields, and the difference (230–200) is 30. From **Table 2.3 on page 33** this is seen to be less than that found by chance alone (40), so the values are accepted.

The concentration of spermatozoa in the sample, for a 1+1 (1 : 2) dilution is  $C = (N/n) \times (2/v)$  spermatozoa/nl. If  $v = 20$  nl ( $\times 400$  magnification),  $C = (430/800) \times (2/20) = 0.0538$  spermatozoa/nl or 54 000 spermatozoa per ml of semen (to two significant figures).

*Example 3*

With a 1+1 (1 : 2) dilution, replicate 1 is found to contain 50 spermatozoa in the whole chamber, while replicate 2 contains 70 spermatozoa in the whole chamber. The sum of the values (50+70) is 120 in the two chambers, and the difference (70–50) is 20. From Table 2.3 this is seen to be less than that found by chance alone (21), so the values are accepted.

When the entire area of both chambers has been assessed (a total of 50  $\mu$ l), the concentration of the sample, for a 1+1 (1 : 2) dilution, is  $C = (N/50) \times 2$  spermatozoa per  $\mu$ l =  $(120/50) \times 2 = 4.8$  spermatozoa/ $\mu$ l or 4 800 spermatozoa/ml of semen (to two significant figures). As fewer than 400 spermatozoa were counted, report the sampling error for 120 spermatozoa given in **Table 2.3 on page 33** (9.3%).

*Example 4*

With a 1+1 (1 : 2) dilution, replicate 1 is found to contain 20 spermatozoa in the whole chamber, while replicate 2 contains 18 spermatozoa in the whole chamber. As fewer than 25 spermatozoa are found in each chamber, the concentration will be < 2000 spermatozoa/ml. Report that "38 spermatozoa were seen in the samples, too few for accurate determination of concentration (< 2000/ml)".

### Example 5

With a 1+1 (1 : 2) dilution, no spermatozoa are found in either replicate. As fewer than 25 spermatozoa are found in each chamber, the concentration will be < 2000 spermatozoa/ml. Report "No spermatozoa were seen in the replicates, too few for accurate determination of concentration (< 2000/ml)".

### Calculation of total number of spermatozoa

It is recommended to calculate and report the total number of spermatozoa per ejaculate, as this parameter provides a measure of testicular sperm production and of the number of spermatozoa transferred to the female during coitus. This is obtained by multiplying the sperm concentration by the volume of the whole ejaculate.

### Examination of centrifuged samples to detect spermatozoa irrespective of motility

When no spermatozoa are observed in either of the wet preparations and the motility status of spermatozoa is not of importance, the sample can be centrifuged to determine if any spermatozoa are present in a larger sample.

1. Mix the semen sample well.
2. Remove a 1-ml aliquot of semen and centrifuge at ideally 3000g for 15 minutes.
3. Decant most of the supernatant and resuspend the sperm pellet in the remaining approximately 50  $\mu$ l seminal plasma.
4. Make one or two 10- $\mu$ l wet preparations (**Section 2.4.3 on page 18**) and assess as described earlier (**Section 2.4.4 on page 19**).
  - The presence of spermatozoa in the sample indicates:
    - passage from the testicle(s) to the urethra
    - severely limited sperm production or hampered sperm transport.
  - The absence of spermatozoa suggests:
    - possible complete absence of spermatozoa (azoospermia), likely caused by:
      - no or extremely low sperm production
      - no passage from testicle(s) to the urethra.

## 2.4.9 Sperm morphology

The value of human sperm morphology assessment is not only the limited prognostic value regarding spontaneous pregnancies or outcome of ART, but even more the diagnostic information about the functional state of the male reproductive organs, primarily the testicles and epididymides. For the evaluation of the male reproductive organs, it is not sufficient to only determine the proportion of "normal" spermatozoa. It is important to evaluate the specific morphology of head, neck/midpiece and tail, and the possible presence of abnormal cytoplasmic residues.

All human ejaculates contain spermatozoa with a wide range of different morphological appearances. Earlier definitions of sperm morphology were based primarily on experiences from veterinary medicine and microscope investigations.



The criteria presented here were developed from investigations of the morphology of spermatozoa able to penetrate cervical mucus and bind to the zona pellucida.

The term “normal” spermatozoon is in some ways ambiguous, causing misunderstandings and even academic conflicts. One general meaning of “normal” is a quality that is common in, for instance, a population. This is not true for “normal sperm morphology” in humans. Another meaning is that it indicates that the cell or individual is not affected by disease, but a normal morphology does not mean that the sperm cannot carry another cause of pathology (e.g. immotile tail or damaged DNA).

The variable morphology of human spermatozoa makes assessment difficult, but observations on spermatozoa recovered from the female reproductive tract, especially in postcoital endocervical mucus (94, 95) and also from the surface of the zona pellucida (96, 97) (**Fig. 2.8 on page 43**), have helped to define the appearance of potentially fertilizing (morphologically normal or, better, “ideal” or “typical”) spermatozoa. By the strict application of certain criteria of sperm morphology, relationships between the percentage of “normal” forms and various fertility end-points (time to pregnancy, pregnancy rates in vivo and in vitro) have been established (58, 96, 98-103), which may be useful for the prognosis of fertility.

The underlying philosophy of the classification system described here is to limit what is identified as typical for the potentially fertilizing subpopulation of spermatozoa prevalent in endocervical mucus. The range of percentage normal forms for both fertile and infertile men is likely to be well under 30% (104). This will inevitably produce low thresholds discriminating between fertile and infertile populations; indeed reference limits and thresholds of 3–5% normal forms have been found in studies of in vitro fertilization (IVF) (99), intrauterine insemination (IUI) (101) and in vivo fertility (105). Furthermore, it should be emphasized that observed differences in group averages between infertile and subfertile men does not automatically mean that the calculated “limits” can be used for the interpretation of results from individual men. To obtain useful such limits, the positive and negative predictive values must be determined. This is difficult, for instance, when it concerns the proportion of “normal” (or “ideal” or “typical”) spermatozoa. To statistically distinguish between, for instance, 3% and 5% “normal” forms for individual men, 1500 spermatozoa must be assessed by highly trained personnel.

Spermatozoa bound to the human zona pellucida also exhibit a subpopulation of morphologically similar spermatozoa (103).

For a better understanding of the human sperm morphology at the light microscopic level, a comprehensive review of sperm ultrastructure and function can be of value (106).

The practical evaluation of human sperm morphology comprises the following steps:

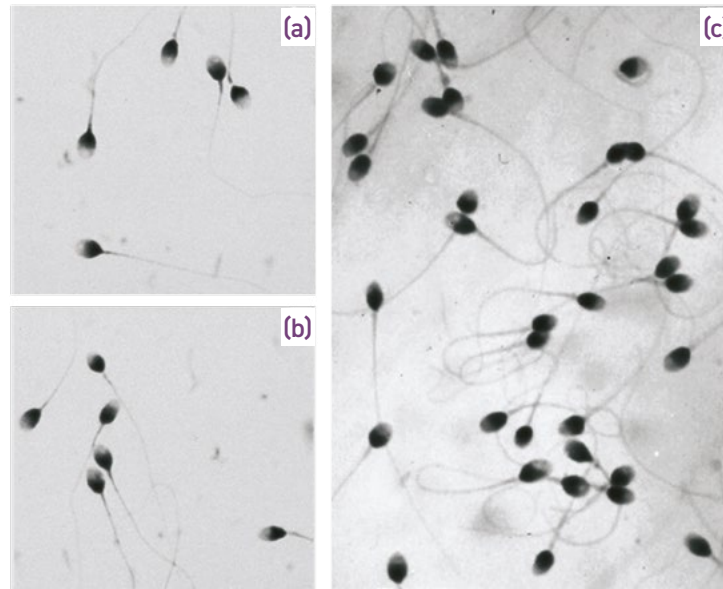
- preparing a smear of ejaculate on a slide (Section 2.4.9.1);
- air-drying, fixing and staining the slide (**Section 2.4.9.2 on page 46**);
- mounting the slide with a coverslip if the slide is to be kept for a long time (**Section 2.4.9.5 on page 48**);
- examining the slide with brightfield optics at ×1000 magnification with oil immersion (**Section 2.4.9.6 on page 48**); and



- assessing approximately 200 spermatozoa (**Section 2.4.9.6**).
- For troubleshooting morphology assessments, see **Section 7.10.2 on page 207**.

### Fig. 2.8 Morphologically "ideal" spermatozoa

(a, b) Shorr-stained spermatozoa recovered from the zona pellucida in vitro. (c) Papanicolaou- stained spermatozoa recovered from endocervical mucus after intercourse. Very few defects on the sperm head, midpiece or principal piece are observed. Tails may be curved but not sharply angulated.(a, b)



Reproduced from Liu et al. (2003) by permission of the European Society of Human Reproduction and Embryology. (c) Reproduced from Menkveld & Kruger (1990) by permission.

#### 2.4.9.1 Preparation of ejaculate smears

Rapid addition of fixative to the ejaculate does not permit adequate visualization of spermatozoa, as they are obscured by denatured seminal proteins. For morphological analysis, it is customary to prepare ejaculate smears that are air-dried before fixation and staining. However, such a process leads to morphological artefacts, since air-drying of semen smears is associated with:

- changes in sperm dimensions: dried, fixed and stained spermatozoa are smaller than live spermatozoa visualized in semen (107);
- expansion of immature sperm heads (Soler et al., 2000); and
- loss of osmotically sensitive cytoplasmic droplets (108, 109), although large amounts of excess residual cytoplasm are retained.

Two or more smears should be made from the fresh semen sample in case there are problems with staining or one slide is broken.

1. Mix the semen sample well.



- Remove an aliquot immediately, allowing no time for the spermatozoa to settle out of suspension.
- Remix the semen sample before removing replicate aliquots (the second smear is for use as a reserve should there be issues with staining).

#### Ejaculates with normal characteristics

In this procedure an aliquot of semen is smeared over the whole surface of the slide by the feathering technique (Fig. 2.9).

- Clean both surfaces of the frosted slides either by rubbing vigorously with lint-free tissue paper or by wiping off with ethanol.
- Label the frosted portion with identifying information with two unique identifiers; ascertain that the marking cannot be made illegible by the fixation, staining or mounting.
- Apply a 5–10- $\mu$ l aliquot of semen, depending on sperm concentration, to the end of the slide. Use a second slide to pull the drop of semen along the surface of the slide (Fig. 2.9). If the dragging slide is non-frosted, the edges of both ends of the slide can be used to make four different smears.
- Allow the slides to dry in air, and stain as described in **Section 2.4.9.2 on page 46**.

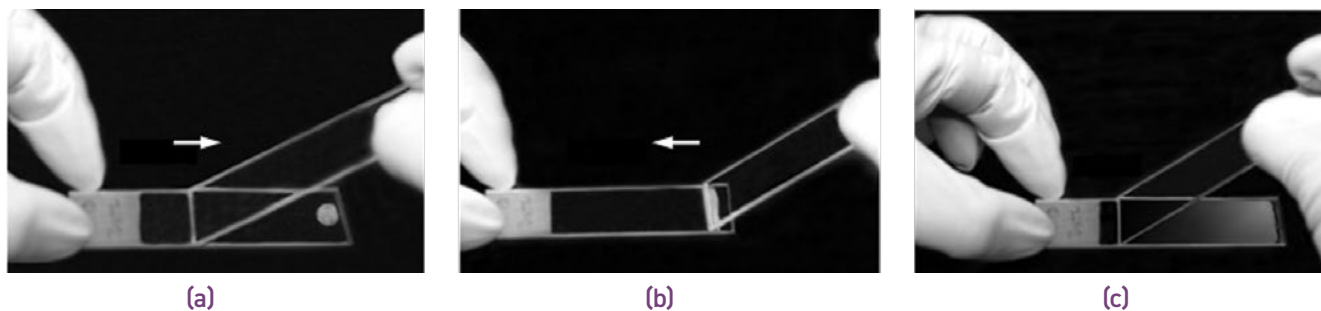
The quality of the smear (minimal overlap of spermatozoa on the slide) depends on:

- the volume of semen and the sperm concentration: the fewer the spermatozoa, the less likely they are to overlap one another;
- the angle of the dragging slide: the smaller the angle, the thinner the smear; and
- the speed of smearing: the more rapid the movement, the thinner the smear.

Start with a volume of 10  $\mu$ l, an angle of 45° and a smear of about 1 second. These parameters can then be varied, if necessary, to reduce overlap of spermatozoa on the slide (95). Feathering works well when semen viscosity is low but is often unsuitable for extremely viscous semen (Fig. 2.9).

**Fig. 2.9 Preparing a normal semen smear**

To get the feel for the motion, place the dragging slide at an angle of 45° and move it into contact with the aliquot of semen (a), which runs along the edge of the slide (b). Bring the dragging slide slowly back (over approximately 1 second) along the length of the slide to produce the smear (c).



Photographs courtesy of C. Brazil.

### Ejaculates with abnormal characteristics

With low sperm concentrations (less than  $2 \times 10^6/\text{ml}$ ), viscous or debris-laden samples, different approaches might be needed.

#### *Ejaculates with low sperm concentration*

If the concentration of spermatozoa is low (e.g. less than  $2 \times 10^6/\text{ml}$ ), concentrate the sample as follows.

1. Centrifuge the sample at 600g for 10 minutes.
2. Remove most of the supernatant.
3. Resuspend the pellet in the remainder of the supernatant by gentle pipetting.
4. Obtain the highest sperm concentration possible, not exceeding approximately  $50 \times 10^6/\text{ml}$ .
5. Treat as a normal sample (**Section 2.4.9.2 on page 46**).



**Note:** This manipulation can affect sperm morphology, and its use must be recorded in the final report.

#### *Viscous ejaculates*

Sometimes it is difficult to prepare good smears because the seminal plasma is highly viscous, resulting in smears of uneven thickness. Viscous samples can be treated in the same way as poorly liquefied samples (**Section 2.5.2 on page 64**) or by washing.



**Note:** These manipulations may affect sperm morphology, and their use must be recorded.

#### *Debris-laden or viscous ejaculates*

Debris and a large amount of particulate material (such as in viscous samples) may cause spermatozoa to lie with their heads on edge, making them difficult to categorize. These samples may be washed, as follows.

1. Dilute an aliquot of well-mixed ejaculate (0.2–0.5 ml, depending on sperm concentration) using a 170 mM saline to reduce osmotic changes to spermatozoa. Depending on how long after ejaculation preparation is done, ejaculate osmolality can have increased to 350–400 mOsm/kg. A medium that is isotonic to general body osmolality (290 mOsm/kg) will induce a hypotonic shock to spermatozoa adapted to the higher osmolality in the liquefied ejaculate (17, 18).
2. Centrifuge at 800g for 10 minutes.
3. Decant most of the supernatant.
4. Resuspend the pellet in the remaining supernatant (typically 20–40  $\mu\text{l}$ ) by gentle pipetting.
5. Make a smear of the suspension by spreading 5–10  $\mu\text{l}$  of sperm suspension on a microscope slide with a Pasteur pipette (Fig. 2.9b).
6. Scan the slide with phase contrast optics at  $\times 400$  magnification to ensure that the smear is evenly spread.

7. Check that there are at least 40 spermatozoa per  $\times 400$  field with no clumping or overlapping.

8. Allow the slides to dry in air, and stain as described in Section 2.4.9.2.

- If too many spermatozoa are overlapping on the slide, make another smear using a smaller aliquot of ejaculate.
- If the spermatozoa are too sparse on the slide, make another smear using a larger aliquot of ejaculate.
- These manipulations may affect sperm morphology, and their use must be recorded.

### 2.4.9.2 Fixation and staining

Once the ejaculate smears have been air-dried, they should be fixed and stained to highlight details of the spermatozoa. The use of Papanicolaou staining is recommended, since thorough validations and evaluations for the Tygerberg Strict Criteria have been done using this type of staining, which gives the best overall visibility of all regions of the human spermatozoon (95, 110-113). The use of other staining should be validated in comparison with the described Papanicolaou staining adapted for human spermatozoa.

With the recommended staining method in brightfield optics (Köhler illumination), the head is stained pale blue in the acrosomal region and dark blue in the post-acrosomal region. It stains the acrosomal and post-acrosomal regions of the head, excess residual cytoplasm, the midpiece and the principal piece. The midpiece may show some red staining, and the tail is stained blue or reddish. Excess residual cytoplasm, usually located behind the head and around the midpiece, is usually stained green; if coloured reddish, it can indicate other abnormalities.

The Papanicolaou stain also gives good staining of other cells. The staining technique described here is sometimes helpful in the distinction between immature germ cells and non-sperm cells (Fig. 2.15 on page 62 and Fig. 2.16 on page 63). Routine procedures have been modified to work without ether (as fixative) or xylene (for mounting) (114) (Section 2.4.9.3). Slides stained using the Papanicolaou procedure can be permanently mounted and stored for future use in training and internal quality control programmes. If stored in the dark, they should be stable for months or years.

There are some other common techniques described in the last part of this chapter: Shorr and rapid staining. The reason for recommending the Papanicolaou staining is that it is still the best evaluated technique. For global use, it is essential that techniques and assessment criteria are standardized. Other techniques can be used, but with proper evaluation and validation with standard techniques, especially if used for scientific studies.

2.4.9.3 Fixation and Papanicolaou<sup>1</sup> staining steps

This involves the following steps.

Table 2.5 Fixation and Papanicolaou staining steps

FIXATION				
Ethanol	95% (v/v)	at least 15 minutes	to fix the cells; it also dehydrates them	
STAINING				
1	Graded ethanol	80% (v/v) <sup>2</sup>	30 seconds	to rehydrate the fixed smears gradually to permit water-soluble haematoxylin staining
2	Graded ethanol	50% (v/v)	30 seconds	
3	Purified water		30 seconds	to rehydrate dried smears to permit water-soluble staining
4	<u>Harris's haematoxylin</u>		4 minutes	to stain the nucleus blue
5	Purified water		30 seconds	to remove unbound nuclear haematoxylin
6	Acidic ethanol <sup>3</sup>		4–8 dips <sup>4,5</sup>	to remove non-specifically bound dye from the cytoplasm (de-staining)
7	Purified water		30 seconds	to reduce acidity and return blue colour to the nucleus; Scott's solution can be used if tap water is insufficient
8	Running cold tap water		5 minutes	
9	Ethanol	50% (v/v)	30 seconds	
10	Ethanol	80% (v/v)	30 seconds	to dehydrate smears to permit ethanol-soluble Orange G/EA-50 staining
11	Ethanol	95% (v/v)	at least 15 minutes	
12	G-6 orange stain		1 minute	to stain the cytoplasm pink
13	Ethanol	95% (v/v)	30 seconds	
14	Ethanol	95% (v/v)	30 seconds	
15	Ethanol	95% (v/v)	30 seconds	
16	EA-50 green stain		1 minute	to stain the cytoplasm and nucleoli pink
17	Ethanol	95% (v/v)	30 seconds	
18	Ethanol	95% (v/v)	30 seconds	
19	Ethanol	100%	15 seconds	to dehydrate the stained smears gradually to permit the use of ethanol-soluble mountants
20	Ethanol	100%	15 seconds	
21	Xylene			to permit the use of ethanol-insoluble mountants

<sup>1</sup> Papanicolaou constituent stains: commercially available or see **Section 8.4.11 on page 229**.

<sup>2</sup> Ethanol fixation causes dehydration of the cells. Therefore, smears taken directly from the fixation step in 95% ethanol for staining may need only 10 seconds in the 80% ethanol, whereas smears that have air-dried after fixation must remain longer (2–3 minutes) in the 50% ethanol.

<sup>3</sup> Acidic ethanol: add 1.0 ml of concentrated hydrochloric acid to 200 ml of 70% (v/v) ethanol.

<sup>4</sup> One dip corresponds to an immersion of about 1 second.

<sup>5</sup> Start with four dips; continue until results are satisfactory. This is a critical step, as the duration of de-staining dramatically alters the final stain intensity. If this step is omitted, spermatozoa and the background will be dark. Increasing the number of dips will make spermatozoa and the background fainter.

Slides can be viewed unmounted or mounted (without or with a coverslip attached). Mounting the slides permits long-term storage, so that they can be reassessed if necessary and used in an internal quality control (IQC) programme. The refractive index (RI) of mountants after drying (1.498–1.55) is similar to that of glass (1.50–1.58), and the best optical quality comes with the use of immersion oil, which has a similar RI (1.515).

#### 2.4.9.4 Treating the stained ejaculate smear before mounting

There are two kinds of fluid for mounting the preparation: ethanol-soluble and ethanol-insoluble mountants.

- Use ethanol-soluble mounting media directly on smears still moist with ethanol.
- If using ethanol-insoluble mounting media, take slides directly from step 19 above through the following steps (to be performed in a fume cupboard):
  - xylene substitute:<sup>6</sup> ethanol, 1+1 (1 : 2)      1 minute
  - 100% xylene substitute                                  1 minute
  - Remove one slide at a time from the xylene substitute staining container and allow it to drain for only 1–2 seconds, as the slide should be quite wet with xylene when mounting.

#### 2.4.9.5 Mounting the stained ejaculate smears

By mounting the stained smears, there is no risk of contamination of microscope objectives.

1. Place the coverslip (24 mm × 50 mm or 24 mm × 60 mm) on a folded paper towel.
2. Place the mountant as a dumbbell shape on the coverslip.
3. Then place the slide, smear-side down, onto the coverslip.
4. Press on the slide to spread the mountant.
5. Allow the mounted smear to dry horizontally, coverslip side up, in a slide drying rack or on absorbent paper overnight in a fume cupboard.

#### 2.4.9.6 Examining the stained preparation

##### Classification of sperm morphology

For useful assessment of sperm morphology, it is essential that it is performed by trained laboratory personnel performing regular IQC. To make interlaboratory comparisons and to implement techniques and decision limits developed in other centres, it is essential to also participate in adequate external quality assessments (EQAs). The classification recommended here is of spermatozoa as either ideal

<sup>6</sup> Xylene is a health hazard and should not be used. There are now substitutes, such as NeoClear.

("typical for sperm able to reach site of fertilization") or abnormal, based on the recognition of abnormalities in all locations of the spermatozoon. To perform a proper morphology assessment, the individual must be familiar with all criteria, meaning that even if the laboratory chooses to report only the proportion of ideal or abnormal spermatozoa, IQC and EQA must evaluate the ability to correctly recognize abnormalities in all locations. The following criteria should be applied when assessing the morphological normality of the spermatozoon (95, 99, 115).

Spermatozoa consist of a head and tail. The part of the tail that is connected to the head and the thicker part that contains mitochondria is called the midpiece. The rest of the tail consists of the principal piece (an axoneme or ciliary structure surrounded by outer dense fibres) and a fibrous sheath with longitudinal columns (116) and an endpiece. As the endpiece is difficult to see with a light microscope, the cell can be considered to comprise a head (and neck) and tail (midpiece and principal piece). For a spermatozoon to be considered without abnormalities, head, midpiece, tail and cytoplasmic residue must be considered normal. All borderline forms should be considered abnormal.

In general, the shape of the head appears to be more important than the exact size (Section 2.5.16 on page 80). It should be noted that abnormally large heads are not normal: diploid sperm exist with a flat side head area ~1.6 times the size of an ideal sperm head. The assessment of normal sperm morphology can best be applied by learning to recognize the subtle variations in shape of the entire spermatozoon (normal/borderline sperm heads and tails; Figs. 2.13, 2.14 and 2.15).

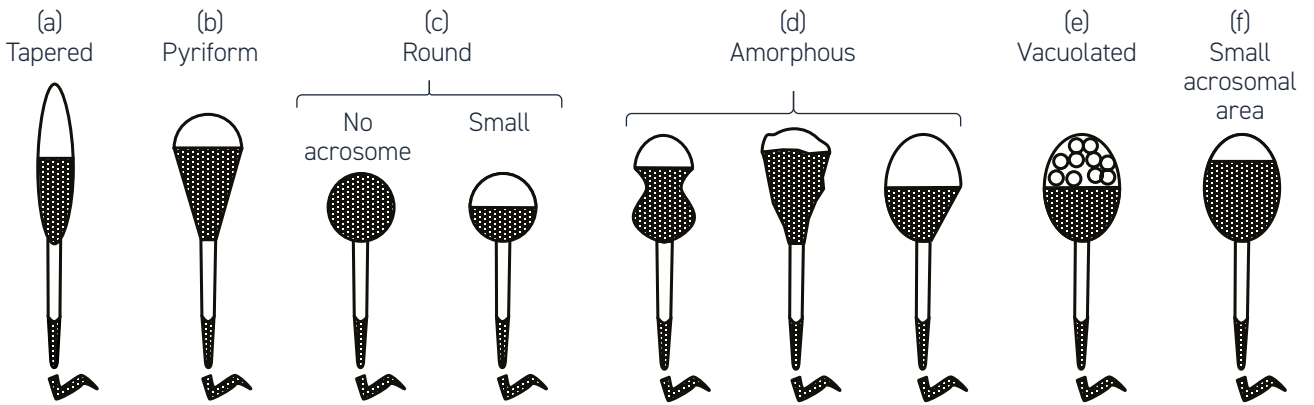
Defective spermatogenesis and some epididymal pathologies are commonly associated with an increased percentage of spermatozoa with abnormal shapes. The morphological defects are usually mixed. Abnormal spermatozoa generally have a lower fertilizing potential, depending on the types of anomalies, and may also have abnormal DNA. Morphological defects have been associated with increased DNA fragmentation (117), an increased incidence of structural chromosomal aberrations (118), immature chromatin (119) and aneuploidy (120, 121). Emphasis is therefore given to the form of the head, although the sperm tail (midpiece and principal piece) is also important to consider for the understanding of the male reproductive tract.

Cytoplasmic residues (122) are normal components of physiologically functional human spermatozoa. Cytoplasmic residues are osmotically sensitive and are not well preserved by routine air-drying procedures (109, 123). They are not obvious in stained preparations, where they may appear as small distensions of the midpiece. If swollen, they may extend along the length of the midpiece, as observed by phase contrast, differential interference contrast and X-ray microscopy of living cells in semen, cervical mucus and medium (108, 124). Excess residual cytoplasm is associated with abnormal spermatozoa produced from a defective spermiation process. This abnormal excess cytoplasm should not be confused with more physiological cytoplasmic residues that can be observed in direct microscopy of the ejaculate but not in dried, fixed and stained morphology smears (16).

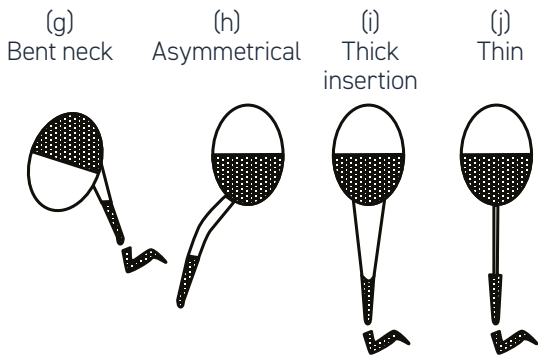
Coiled tails (more than 360°, Fig. 2.10) may indicate epididymal dysfunction (125).

Fig. 2.10 Schematic drawings of some abnormal forms of human spermatozoa

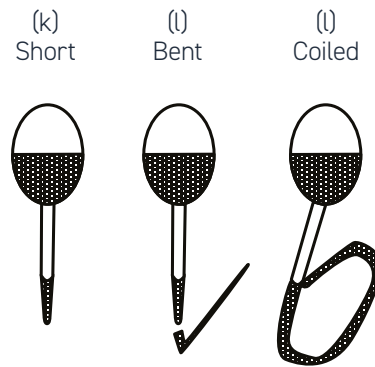
**A. Head defects**



**B. Neck and midpiece defects**



**C. Tail defects**



**D. Excess residual cytoplasm**

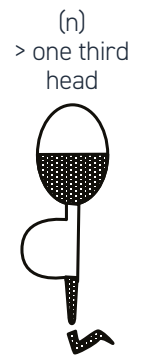




Table 2.6 Classification of sperm morphology

Location	Normal (ideal/typical) appearance	Abnormal
<b>Head</b>	The head should be smooth, regularly contoured and generally oval in shape. There should be a well-defined acrosomal region comprising 40–70% of the head area (96). The acrosomal region should contain no large vacuoles, and not more than two small vacuoles, which should not occupy more than one fifth of the sperm head. The post-acrosomal region should not contain any vacuoles.	<ul style="list-style-type: none"> <li>• acrosome less than 40% or larger than 70% of a normal head area, or</li> <li>• length-to-width ratio less than 1.5 (round) or larger than 2 (elongated), or</li> <li>• shape: pyriform (pear shaped), amorphous, asymmetrical, or non-oval shape in the apical part, or</li> <li>• vacuoles constitute more than one fifth of the head area or located in the post-acrosomal area, or</li> <li>• double heads, or</li> <li>• any combinations</li> </ul>
<b>Midpiece</b>	The midpiece should be slender, regular and about the same length as the sperm head. The major axis of the midpiece should be aligned with the major axis of the sperm head.	<ul style="list-style-type: none"> <li>• irregular shape, or</li> <li>• thin or thick, or</li> <li>• asymmetrical or angled insertion at head, or</li> <li>• sharply bent, or</li> <li>• any combinations</li> </ul>
<b>Tail</b>	The principal piece should have a uniform calibre along its length, be thinner than the midpiece and be approximately 45 µm long (about 10 times the head length). It may be looped back on itself, provided there is no sharp angulation indicative of a broken flagellum.	<ul style="list-style-type: none"> <li>• sharply angulated bends, or</li> <li>• smooth hairpin bends, or</li> <li>• coiled, or</li> <li>• short (broken), or</li> <li>• irregular width, or</li> <li>• multiple tails, or</li> <li>• any combinations</li> </ul>
<b>Cytoplasmic residue</b>	Cytoplasmic droplets (less than one third of a normal sperm head size) are normal.	<ul style="list-style-type: none"> <li>• residual cytoplasm is considered an anomaly only when it exceeds one third of normal sperm head size</li> </ul>

#### Categories of sperm abnormalities

The categories, or regions, of interest are:

- head (%H)
- neck and midpiece (%NM)
- tail (%T)
- excess residual cytoplasm (%C).

A multikey-counter can be used, with one key for normal (ideal, typical), one for abnormal, and one for each of the four abnormal categories (H, NM, T, C). A mechanical counter can be used for entry of multiple abnormalities by keeping the first key pressed down while entering the other abnormalities observed on a single



sperm. By that operation, each spermatozoon is counted only once, and each of its abnormalities is scored separately.

- From the assessment of 200 spermatozoa, it is possible to obtain the percentage of ideal and abnormal spermatozoa (the two figures should add up to 100%), as well as the percentage with each type of abnormality – i.e. %H, %NM, %T and %C (the sum of these latter figures should be more than 100% if assessment is done correctly).
- The percentage of spermatozoa in these abnormality classes is obtained by dividing the total number of spermatozoa with a defect in the category by the total number scored. These numbers are used to calculate the teratozoospermia index (TZI) (**Section 3.2 on page 86**).

#### Descriptions of other specific sperm defects and other cell types

Occasionally, many spermatozoa will have a specific structural defect. For example, the acrosome may fail to develop, giving rise to the “round-head defect” or “globozoospermia”. If the basal plate fails to attach to the nucleus at the opposite pole to the acrosome at spermiation, the heads are absorbed, and only tails are found in semen (the so-called “pinhead defect”). Pinheads (free tails) are not counted as head defects, since they possess no chromatin or head structure anterior to the basal plate. Patients whose spermatozoa all display one of these defects are usually sterile. Such cases are rare, but it is critical that they are identified and correctly reported. If there are many pinheads or free heads, their prevalence relative to spermatozoa can be determined (**Sections 2.5.16 and 2.5.17**).

Report the presence and prevalence relative to spermatozoa of:

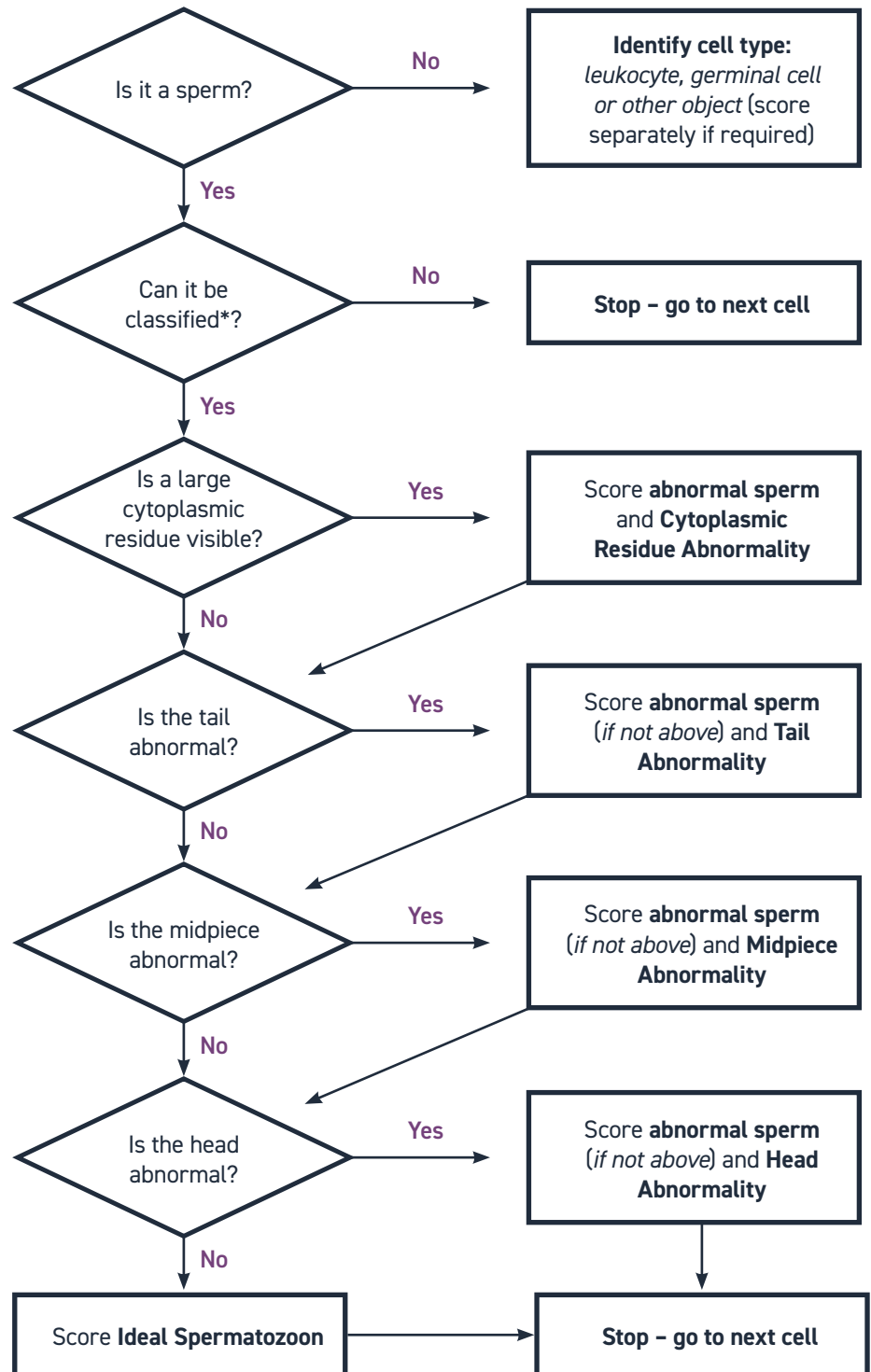
- specific sperm defects, e.g. free sperm heads, pinheads (free tails), heads lacking acrosomes
- immature germ cells (Figs. 2.15 and 2.16)
- non-sperm cells (Figs. 2.15 and 2.16).

If there are many such defects or non-sperm cells, their prevalence relative to spermatozoa can be determined.

#### A structured order for the assessment of human sperm morphology

The didactic sequential assessment of each spermatozoon is useful both when training and when performing routine analysis (126).

Fig. 2.11 Structured order for the assessment of human sperm morphology



\* Complete with head and tail, clearly visible and not overlapped by other cells or objects

### Microscopic assessment and calculations of results

With the morphology assessment paradigm recommended here, all functional regions of the spermatozoon should be considered. It is unnecessary to distinguish all the variations in head size and shape or the various midpiece and principal piece defects. Even if the laboratory only reports the proportion of ideal spermatozoa, the examiner in the laboratory must be able to identify all abnormalities. Morphological evaluation should be performed on every assessable spermatozoon in several systematically selected areas of the slide, to prevent biased selection of particular spermatozoa.

It is recommended to start by surveying the smear at, for instance,  $\times 400$  total magnification (brightfield optics) to obtain a general impression of sperm distribution and appearance, other cells, debris etc.

The detailed assessment is done using  $\times 100$  oil-immersion brightfield objective and at least a  $\times 10$  eyepiece. Immersion oil is essential for best image in the microscope (refractive index, RI  $\sim 1.5$ ).

1. Assess all spermatozoa in each field, moving from one microscopic field to another.

- Assess only intact spermatozoa (those with a head and a tail). Do not include immature cells in the sperm count. Heads without tails should be tallied separately and noted in the report if more than 20 per 100 spermatozoa.
- Do not assess fields with overlapping spermatozoa or with a side-on sperm. Only if all fields have such a problem are spermatozoa in such fields assessed, and then with an additional comment in the report.

2. Evaluate at least 200 spermatozoa, to achieve an acceptably low sampling error.

3. Tally the number of typical or normal spermatozoa and abnormalities in the four regions with the aid of a laboratory counter.

4. Calculate:

- the proportions of typical forms and the proportions of abnormalities in the different regions; and
- the TZI (the sum of all abnormalities divided by the sum of abnormal spermatozoa, thus always giving a result between 1.00 and 4.00). The TZI has a maximum of four defects per abnormal spermatozoon: one each for head, midpiece and principal piece, and one for excess residual cytoplasm.

5. Report the percentages of typical forms to the nearest whole number, and the TZI with two decimal places.



Fig. 2.12 Papanicolaou plate 1

Plate 1

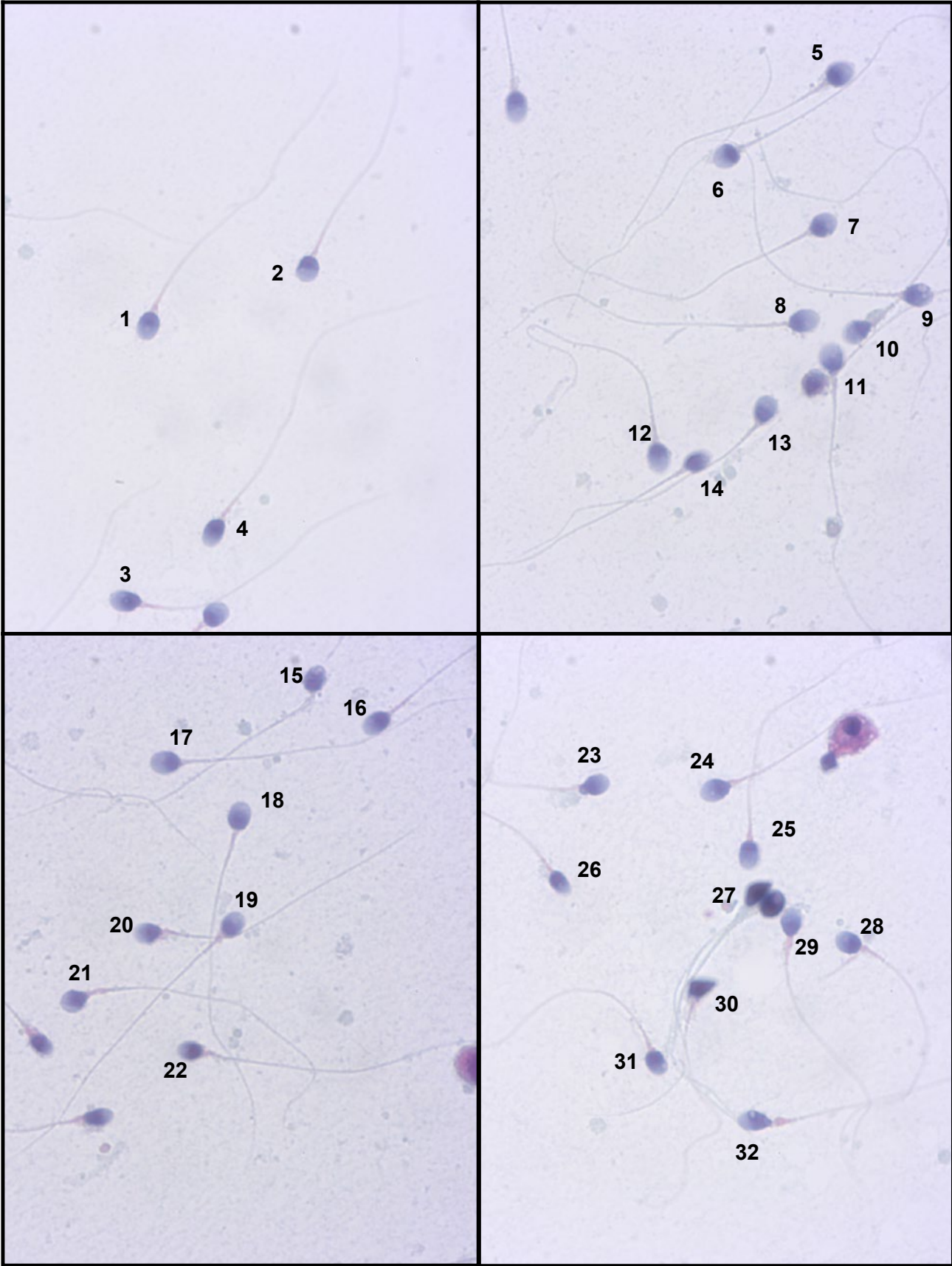
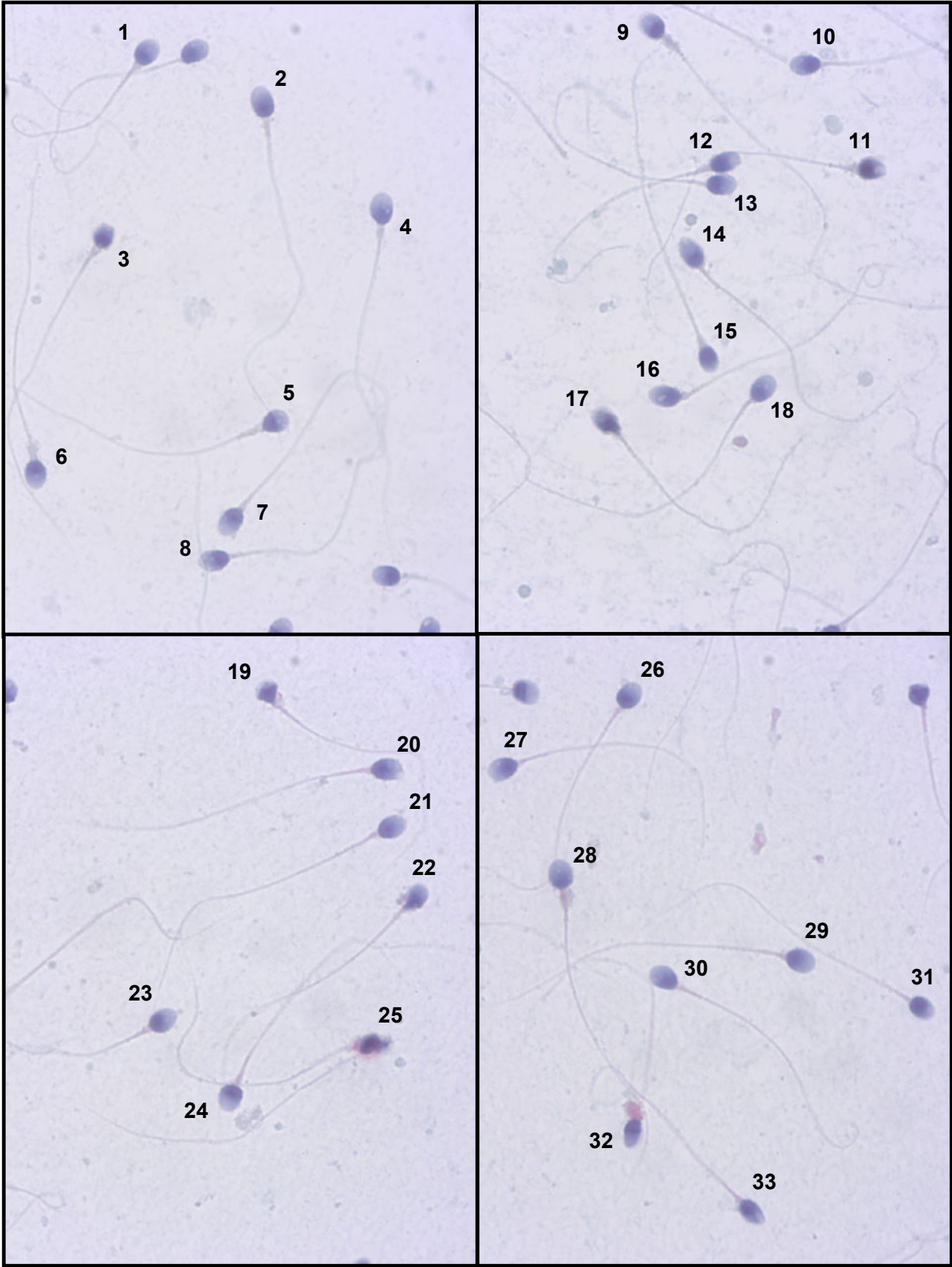


Table 2.7 Papanicolaou plate 1

	Head shape	Other head comments	Midpiece comments	Principal piece comments	Overall sperm classification
1	normal		normal	normal	normal
2	abnormal	amorphous	normal	normal	abnormal
3	abnormal	amorphous	thick	normal	abnormal
4	abnormal		normal	normal	abnormal
5	abnormal	not oval	thick	normal	abnormal
6	abnormal	not oval	normal	normal	abnormal
7	abnormal	PA vac	thick	normal	abnormal
8	normal		normal	normal	normal
9	abnormal	vac	normal	normal	abnormal
10	abnormal	not oval	thick	normal	abnormal
11	abnormal	not oval	thick	normal	
12	normal		normal	normal	normal
13	abnormal		thick/bent	normal	abnormal
14	abnormal	small	normal	normal	abnormal
15	abnormal		thick	normal	abnormal
16	abnormal		normal	NA	abnormal
17	normal		normal	normal	Normal
18	normal		normal	normal	Normal
19	normal		thick	normal	abnormal
20	abnormal		thick	normal	abnormal
21	abnormal		thick	normal	abnormal
22	abnormal		thick	normal	abnormal
23	abnormal		thick	NA	abnormal
24	abnormal		thick	normal	abnormal
25	normal		thick	normal	abnormal
26	abnormal	tapered	thick	NA	abnormal
27	abnormal	not oval	thick	normal	abnormal
28	normal		thick	normal	normal
29	abnormal		thick	normal	abnormal
30	abnormal	not oval	thick	doubled	
31	abnormal		asymmetrical	normal	abnormal
32	abnormal	not oval/PA vac	normal	normal	abnormal

Fig. 2.13 Papanicolaou plate 2

Plate 2



1. Introduction

2. Basic examination

3. Extended examination

4. Advanced examinations

5. Sperm preparation techniques

6. Cryopreservation of spermatozoa

7. Quality assurance and quality control

8. Appendices

9. References

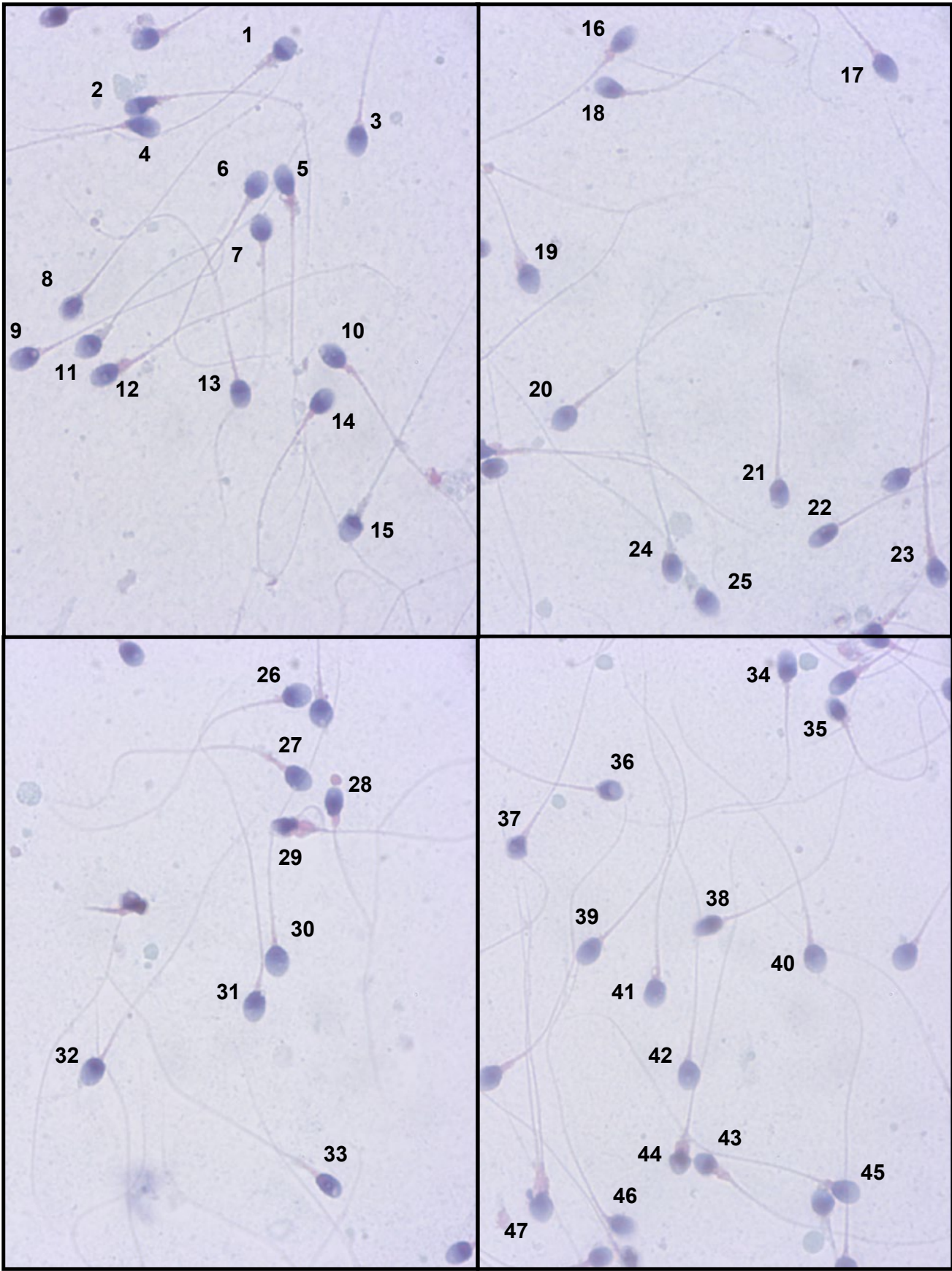
Table 2.8 Papanicolaou plate 2

	Head shape	Other head comments	Midpiece comments	Principal piece comments	Overall sperm classification
1	normal		thick	normal	abnormal
2	abnormal		normal	normal	normal
3	abnormal		thick	normal	abnormal
4	abnormal		thick	normal	abnormal
5	abnormal		thick	normal	abnormal
6	normal		thick	normal	abnormal
7	normal		normal	normal	normal
8	abnormal		normal	asymmetrical	abnormal
9	abnormal		thick	normal	abnormal
10	abnormal		normal	NA	abnormal
11	abnormal		thick	normal	abnormal
12	abnormal		thick	asymmetrical	abnormal
13	normal		normal	NA	abnormal
14	abnormal		normal	normal	abnormal
15	abnormal	small	thick/asymmetrical	normal	abnormal
16	abnormal		thick	normal	abnormal
17	abnormal		thick	normal	abnormal
18	normal		normal	normal	normal
19	abnormal		thick	normal	abnormal
20	abnormal		normal	normal	abnormal
21	normal		normal	normal	normal
22	abnormal		normal	normal	abnormal
23	abnormal		thick	abnormal	abnormal
24	abnormal	too wide	thick	abnormal	abnormal
25	abnormal		thick	normal	abnormal
26	abnormal		normal	normal	abnormal
27	normal		normal	normal	normal
28	abnormal		thick	normal	abnormal
29	normal		normal	normal	normal
30	abnormal	small	normal	normal	abnormal
31	abnormal		normal	normal	abnormal
32	abnormal		thick	asymmetrical	abnormal
33	abnormal	tapered	thick	normal	abnormal



Fig. 2.14 Papanicolaou plate 3

Plate 3



- 1. Introduction
- 2. Basic examination
- 3. Extended examination
- 4. Advanced examinations
- 5. Sperm preparation techniques
- 6. Cryopreservation of spermatozoa
- 7. Quality assurance and quality control
- 8. Appendices
- 9. References

Table 2.9 Papanicolaou plate 3

	Head shape	Other head comments	Midpiece comments	Principal piece comments	Overall sperm classification
1	abnormal		thick	normal	abnormal
2	abnormal		thick	bent	abnormal
3	abnormal		thick/asymmetrical	NA	abnormal
4	abnormal		thick	NA	abnormal
5	abnormal		thick	normal	abnormal
6	normal		normal	normal	normal
7	normal		normal	normal	normal
8	abnormal	small	normal	normal	abnormal
9	abnormal	PA vac	thick	normal	abnormal
10	abnormal		thick	normal	abnormal
11	abnormal		thick	normal	abnormal
12	normal		normal	normal	normal
13	abnormal		thick	normal	abnormal
14	normal		thick	normal	abnormal
15	abnormal		thick	normal	abnormal
16	abnormal		thick	normal	abnormal
17	abnormal		normal	normal	abnormal
18	abnormal		normal	NA	abnormal
19	abnormal		thick	NA	abnormal
20	normal		normal	normal	normal
21	abnormal		normal	normal	abnormal
22	abnormal	tapered	normal	normal	abnormal
23	abnormal		thick	double	abnormal
24	abnormal	small	thick	normal	abnormal
25	abnormal		thick	normal	abnormal
26	normal		normal	normal	normal
27	normal		thick	normal	abnormal
28	abnormal		thick	bent	abnormal
29	abnormal	small	thick	normal	abnormal
30	normal		normal	normal	normal
31	abnormal		normal	normal	abnormal
32	normal		normal	normal	normal
33	abnormal	tapered	normal	normal	abnormal
34	abnormal		normal	normal	abnormal

	Head shape	Other head comments	Midpiece comments	Principal piece comments	Overall sperm classification
35	abnormal	small	thick	normal	abnormal
36	abnormal	small	normal	normal	abnormal
37	abnormal	small	normal	normal	abnormal
38	abnormal		normal	normal	abnormal
39	abnormal	tapered	normal	normal	abnormal
40	normal		normal	normal	normal
41	abnormal		thick	normal	abnormal
42	abnormal		asymmetrical	normal	abnormal
43	abnormal		thick	normal	abnormal
44	abnormal		thick	normal	abnormal
45	abnormal		thick	normal	abnormal
46	abnormal		normal	normal	abnormal
47	abnormal		thick	doubled	abnormal

Table 2.10 Papanicolaou plate 4

Cell	Cell type	Cell	Cell type	Cell	Cell type
1	macrophage	9	dividing spermatid	17	dividing spermatocyte
2	abnormal spermatozoon	10	spermatocyte	18	abnormal spermatozoon
3	cytoplasm	11	degenerating spermatid	19	cytoplasm
4	abnormal spermatozoon	12	spermatid	20	abnormal spermatozoon
5	spermatocyte	13	degenerating spermatid	21	spermatid
6	abnormal spermatozoon	14	dividing spermatocyte	22	phagocytosing macrophage
7	abnormal spermatozoon? loose head on cytoplasm?	15	cytoplasm	23	spermatocyte
8	cytoplasm	16	degenerating spermatid	24	cytoplasm

Table 2.11 Papanicolaou plate 5

Cell	Cell type	Cell	Cell type	Cell	Cell type
1	macrophage	7	degenerating spermatid	13	degenerating spermatid
2	abnormal spermatozoon	8	degenerating spermatid?	14	degenerating spermatid
3	(dividing) spermatid	9	degenerating spermatid	15	degenerating spermatid
4	(dividing) spermatid	10	degenerating spermatid	16	macrophage
5	cytoplasm	11	macrophage		
6	not classifiable	12	degenerating spermatid		

Fig. 2.15 Papanicolaou plate 4

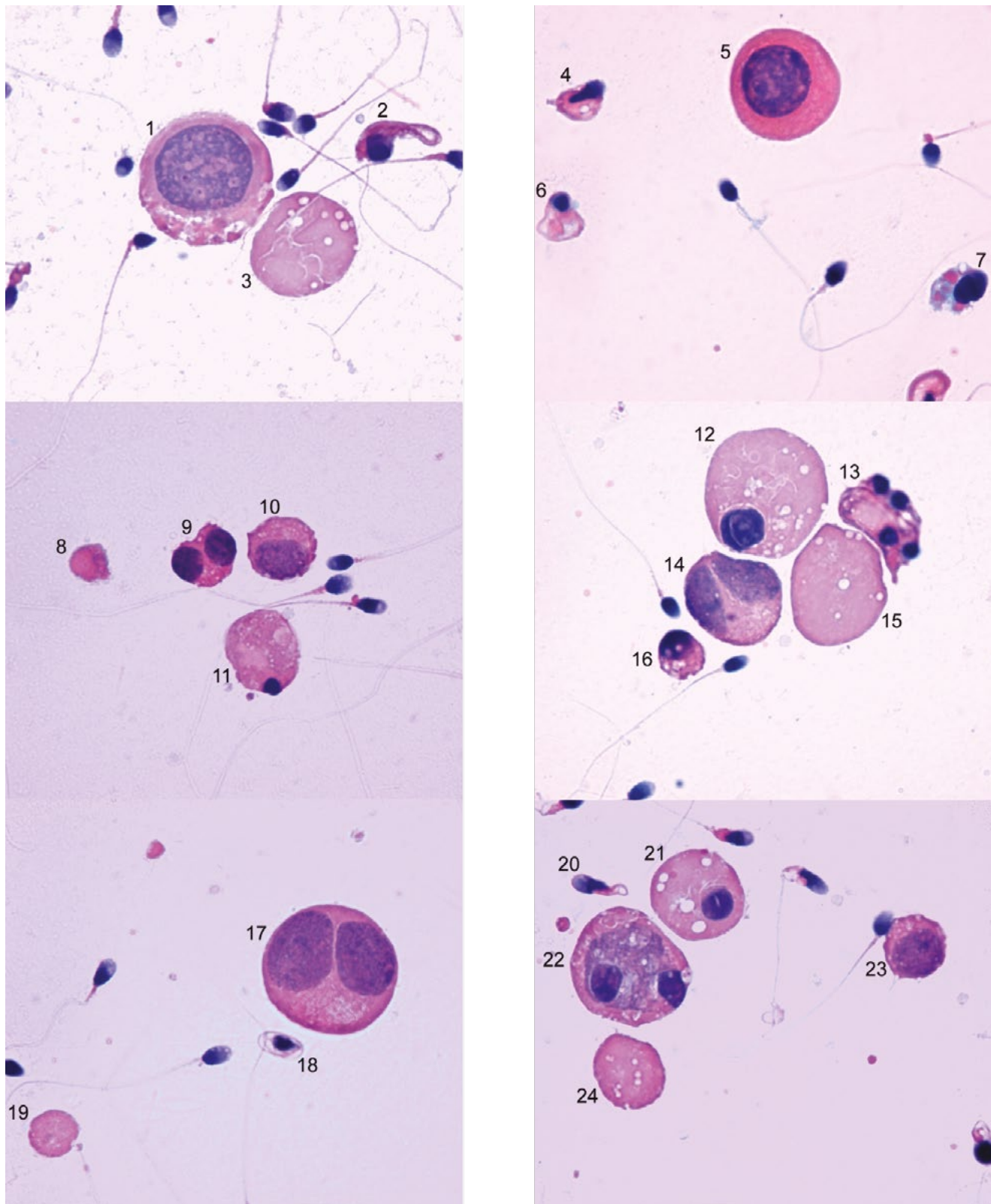
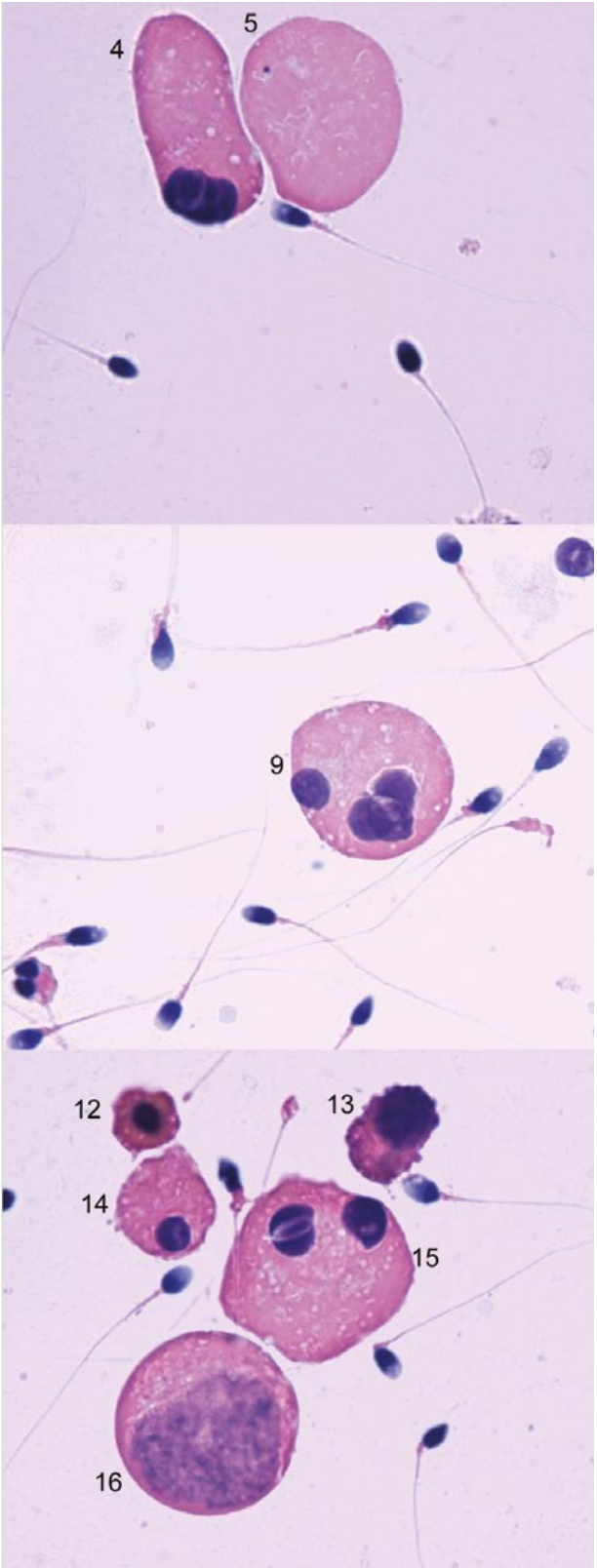
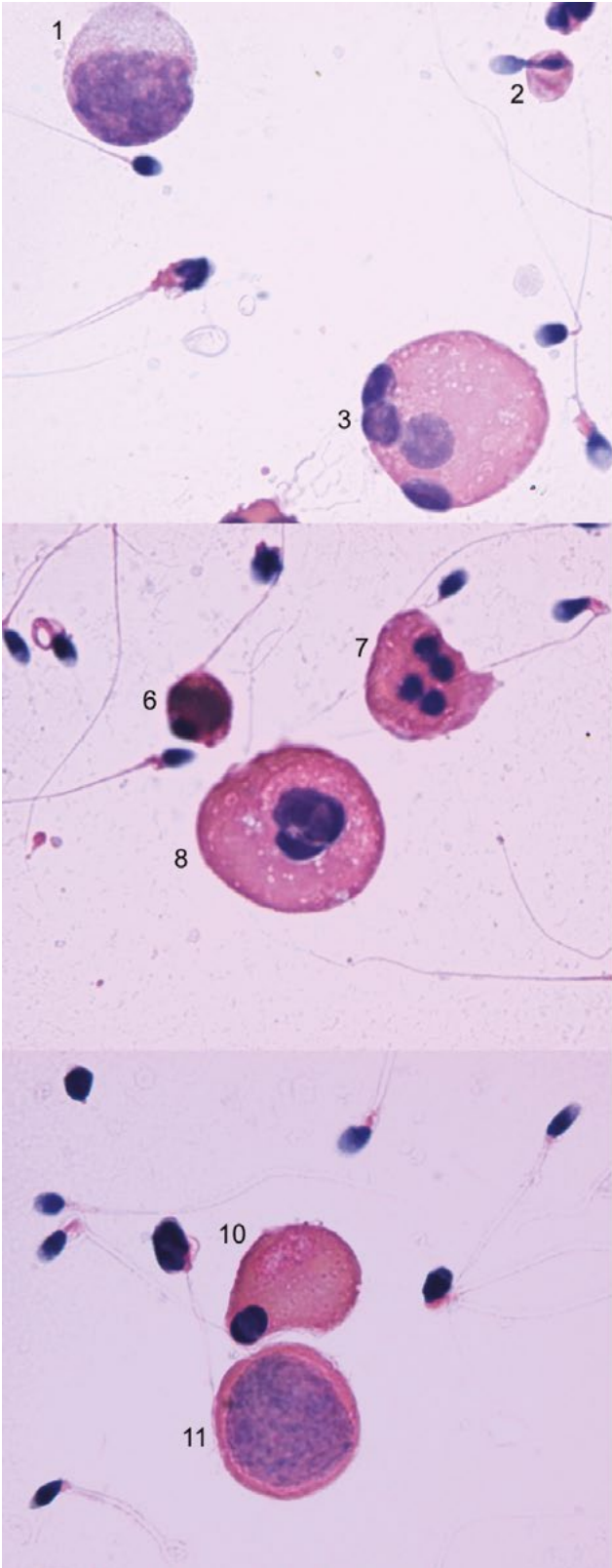


Fig. 2.16 Papanicolaou plate 5



1. Introduction

2. Basic examination

3. Extended examination

4. Advanced examinations

5. Sperm preparation techniques

6. Cryopreservation of spermatozoa

7. Quality assurance and quality control

8. Appendices

9. References

## 2.5 Additional information and comments

### 2.5.1 Background for ejaculate volume assessment

- The volume measured using a measure pipette will always be affected by a loss of 0.3–0.9 ml (50, 51, 127). There can also be unseen air bubbles inside a volumetric pipette that can cause an over-estimation of ejaculate volume. Also, some volume is lost in the pipette itself, which can cause difficulties for other assessments in low-volume ejaculates.
- Low semen volume is characteristic of obstruction of the ejaculatory duct or congenital bilateral absence of the vas deferens (CBAVD) (128–131), a condition in which the seminal vesicles are also poorly developed.
- Low semen volume can also be the result of collection problems (loss of a fraction of the ejaculate), partial retrograde ejaculation or androgen deficiency.
- High semen volume may reflect active exudation in cases of active inflammation of the accessory organs.

### 2.5.2 Liquefaction problems

- Occasionally samples may not liquefy, making diagnostic semen evaluation practically impossible. In these cases, additional treatment, mechanical mixing or enzymatic digestion may allow further assessments, but the manipulations will affect seminal plasma biochemistry, sperm motility and sperm morphology, and their use must be reported. The dilution of semen with culture medium must be accounted for when calculating sperm concentration. Positive displacement pipetting of semen should be used to allow for best accuracy possible.
- Some samples can be induced to liquefy by the addition of an equal volume of physiological medium or Dulbecco's phosphate-buffered saline, see **Section 8.4.5 on page 227**, followed by repeated gentle pipetting. However, the addition of a culture medium will change sperm motility and concentration, as well as biochemical markers.
- Inhomogeneity can be reduced by repeated (6–10 times) gentle passage through a blunt gauge 18 (internal diameter 0.84 mm) or gauge 19 (internal diameter 0.69 mm) needle attached to a syringe. However, this is not recommended, since the shearing forces are likely to damage spermatozoa and thereby negatively affect the DNA integrity (132).
- Digestion by bromelain, a broad-specificity proteolytic enzyme (EC 3.4.22.32), may help to promote liquefaction, but will change both biochemical markers and sperm motility.  
Prepare 10 IU/ml bromelain in Dulbecco's phosphate-buffered saline (**Section 8.4.5 on page 227**); it is difficult to dissolve, but, with mixing, most should dissolve within 15–20 minutes. Dilute semen 1+1 (1 : 2) with the 10 IU/ml bromelain, stir with a pipette tip, and incubate at 37 °C for 10 minutes. Mix the sample well before further analysis.

### 2.5.3 Alternative viscosity assessments

- Alternatively, the viscosity can be evaluated by introducing a glass rod into the sample and observing the length of the thread that forms upon withdrawal of the rod.
- In contrast to a partially unliquified sample, a viscous ejaculate specimen exhibits homogeneous stickiness, and its consistency will not change with time. High viscosity can hinder proper assessment of sperm motility and concentration, detection of anti-sperm antibodies and assessment of biochemical markers. Methods to reduce viscosity are the same as those for liquefaction problems (**Section 2.5.2 on page 64**) and will therefore affect several aspects of ejaculate characteristics. Even if viscosity thus can be improved, it will affect the results of ejaculate examination.

### 2.5.4 Ejaculate pH

- If the pH is less than 7.0 in an ejaculate without spermatozoa, there may be a congenital bilateral absence of the vas deferens (*129-131, 133*), and due to the common embryonic origin, seminal vesicles may also be missing or poorly developed, causing a low volume and low pH.
- For viscous samples, the pH of a small aliquot of the ejaculate can be measured using a pH meter designed for measurement of viscous solutions (*134*).

### 2.5.5 Sample mixing

- Alternatively, mixing can be achieved by aspirating the sample ~10 times into a wide bore (approximately 1.5 mm diameter aperture) disposable plastic pipette (sterile when necessary). Care must then be taken not to cause air bubbles. Do not mix with a vortex mixer, as this will damage spermatozoa.

### 2.5.6 Wet preparation – principles

- The volume of ejaculate and the dimensions of the coverslip (size and weight) must be adjusted to give a preparation of fixed depth of about 20  $\mu\text{m}$ , which allows the spermatozoa to swim freely (*135, 136*). A deeper preparation is likely to cause difficulties, because the microscope focal depth will not comprise the entire depth of the preparation, making sperm appear and disappear as they move in and out of focus.
- The depth of a preparation ( $D \mu\text{m}$ ) is obtained by dividing the volume of the sample ( $V, \mu\text{l} = \text{mm}^3$ ) by the area over which it is spread ( $A, \text{mm}^2$ ):  $D = V/A$ . Thus, a volume of 10  $\mu\text{l}$  on a clean glass slide and covered with a 22 mm  $\times$  22 mm coverslip (area 484  $\text{mm}^2$ ) provides a chamber of depth 20.7  $\mu\text{m}$ .

#### 2.5.6.1 Probability of undetected spermatozoa from scanning wet preparations

If no spermatozoa are detected in one or two wet preparations, there is a low probability that spermatozoa may still exist in the ejaculate, partially depending on the total volume of the ejaculate. The probability of a certain number of undetected spermatozoa can be estimated by calculating the confidence interval of the value from a Poisson



distribution (137) – meaning that if finding no spermatozoa in the wet preparation, fewer than the number of spermatozoa shown in Table 2.12 are expected to be found in the entire ejaculate with 95% and 99.5% probability, respectively. The table shows the outcomes of different volumes and of one or two 10 µl wet preparations examined.

**Table 2.12 Probability of undetected spermatozoa from scanning wet preparations**

Ejaculate volume (ml)	Undetected sperm (95% confidence interval)		Undetected sperm (99.5% confidence interval)	
	10 µl	20 µl	10 µl	20 µl
1	300	150	530	265
2	600	300	1060	530
4	1200	600	2120	1060
8	2400	1200	4240	2120

### 2.5.6.2 Probability of undetected spermatozoa after centrifugation

If no spermatozoa are detected in one or two wet preparations from centrifugation pellets, there is a low probability that spermatozoa may still exist in the ejaculate, partially depending on the total volume of the ejaculate. The probability of a certain number of undetected spermatozoa can be estimated by calculating the confidence interval of the value from a Poisson distribution (137) – meaning that if finding no spermatozoa in the wet preparation, fewer than the number of spermatozoa shown in Table 2.13 are expected to be found in the entire ejaculate with 95% and 99.5% probability, respectively. The table shows the outcomes of different volumes and of one or two 10 µl wet preparations examined. In the table, the concentration by centrifugation has been calculated as 1 ml to 50 µl (20×).

**Table 2.13 Probability of undetected spermatozoa after centrifugation**

Ejaculate volume (ml)	Undetected sperm (95% confidence interval)		Undetected sperm (99.5% confidence interval)	
	10 µl	20 µl	10 µl	20 µl
1	15	8	27	14
2	30	15	53	27
4	60	30	106	53
8	120	60	212	106

### 2.5.7 Sperm agglutinates

- The presence of agglutination is not sufficient evidence to deduce an immunological cause of infertility but is suggestive of the presence of anti-sperm antibodies; further testing may be required (**Section 3.7 on page 119**).
- Severe agglutination can affect the assessment of sperm motility and concentration.



### 2.5.8 Sperm counting chambers

- Spermatozoa stick easily to glass surfaces. Thorough cleaning is therefore essential.
  - Clean the haemocytometer chamber and coverslip with water and detergent.
  - Gently rubbing the grid surface will remove any residual spermatozoa from the previous sample.
  - Dry well with tissue after use, as any dried residue can inhibit loading.
- According to existing health and safety regulations, the risk of contamination with a potentially infectious agent should be counteracted, for instance by soaking reusable chambers and coverslips overnight in disinfectant (**Section 8.2.5 on page 219**)
- Disposable chambers are available for determining sperm concentration (86, 138-141), but they may produce different results from those of the improved Neubauer haemocytometer.
- Shallow chambers (typically 20  $\mu\text{m}$ ) that fill by capillary action do not have a uniform distribution of spermatozoa because of the effect of streaming (142, 143). It might be possible to correct for this (143), but it is not advised (144).

### 2.5.9 Area and volume of a high-power microscopy field (HPF)

The volume of semen observed in each microscopic field depends on the depth of the preparation and the area of the field ( $\pi r^2$ , where  $\pi$  is approximately 3.142 and  $r$  is the radius of the microscopic field) and the depth of the chamber (20.7  $\mu\text{m}$  for the wet preparation). The diameter of the microscopic field can be measured with a stage micrometer or can be estimated by dividing the diameter of the aperture of the ocular lens by the magnification of the objective lens.

With a  $\times 40$  objective and a  $\times 10$  ocular of aperture 20 mm, the microscope field has a diameter of approximately 500  $\mu\text{m}$  (20 mm/40). In this case,  $r = 250 \mu\text{m}$ ,  $r^2 = 62\,500 \mu\text{m}^2$ ,  $\pi r^2 = 196\,375 \mu\text{m}^2$ , and the volume is 4 064 962  $\mu\text{m}^3$  or about 4 nL.

With a  $\times 20$  objective and a  $\times 10$  ocular of aperture 20 mm, the microscope field has a diameter of approximately 1000  $\mu\text{m}$  (20 mm/20). In this case,  $r = 500 \mu\text{m}$ ,  $r^2 = 250\,000 \mu\text{m}^2$ ,  $\pi r^2 = 785\,500 \mu\text{m}^2$ , and the volume is 16 259 850  $\mu\text{m}^3$  or about 16 nL.

### 2.5.10 Toxicity testing of ejaculate collection vessels

Select at least five ejaculates with high sperm concentration and good sperm motility. The ejaculates must be collected in the known safe containers (control), and then half transferred into the unknown containers (test). Assess sperm motility (**Section 2.4.6 on page 23**) directly and after 4 hours. This duration is suggested, as it is double any likely exposure time of semen to the container. Native semen should be used, as that is the relevant exposed fluid. If there are no differences at each time point between control and test assessments ( $P > 0.05$  as judged by a paired t-test), the test containers can be considered to be non-toxic to spermatozoa and to meet semen collection requirements. Other items used in diagnostic semen analysis, such as pipette tips, should be tested for an effect, with exposure time duly accounted for.



## 2.5.11 Sterile collection of semen for assisted reproduction and cryostorage

This is performed as for diagnostic collection, but the specimen containers, pipette tips and pipettes for mixing must be sterile. Legal requirements may differ, but it is often required that procedures for sperm preparation reduce the risk of contamination with microorganisms and other particles. A clean space (Laminar Air Flow hood) and controlled air quality are often required.

## 2.5.12 Sterile collection of semen for microbiological analysis

Is well known that it is difficult to obtain useful information from microbiological cultures of semen. It is therefore important to minimize microbiological contamination from non-semen sources (e.g. commensal organisms from the skin). The specimen containers, pipette tips and pipettes for mixing must be sterile. Ideally take the aliquots for microbiological testing before performing any other assessments on the ejaculate. The time between collection of the semen sample and the start of the investigation by the microbiological laboratory should not exceed 3 hours.

The man should:

- pass urine;
- wash his hands and penis with soap, to reduce the risk of contamination of the specimen with commensal organisms from the skin;
- rinse away the soap;
- dry his hands and penis with a fresh disposable towel; and
- ejaculate into a sterile container.

## 2.5.13 Alternative vitality tests

### 2.5.13.1 Vitality test using eosin alone

This method is simple and rapid, but the wet preparations cannot be stored for quality control purposes, and negative phase contrast optics are required to obtain reliable results. These optics are very difficult to source, and the more common positive phase contrast makes faint pink heads difficult to discern.

Preparing the reagents

1. 0.9% (w/v) NaCl: dissolve 0.9 g of NaCl in 100 ml purified water.
  2. 0.5% (w/v) eosin Y: dissolve 0.5 g of eosin Y (colour index 45380) in 100 ml of 0.9% NaCl.
- If a commercially available eosin solution is a hypotonic aqueous solution it can kill some of the spermatozoa and give false positive results (75). If using such a solution, use a 170 mM saline to make it approximately isotonic with the ejaculate (17).



### Procedure

1. Mix the ejaculate well.
2. Remove an aliquot of 5  $\mu$ l of ejaculate and combine with 5  $\mu$ l of eosin solution on a microscope slide. Mix with a pipette tip, swirling the sample on the slide.
3. Cover immediately with a 22 mm  $\times$  22 mm coverslip and leave for 30 seconds.
4. Examine the slide with negative phase contrast optics at  $\times$ 200 or  $\times$ 400 magnification.
5. Tally the number of stained (dead) and unstained (vital) cells with the aid of a laboratory counter.
6. Evaluate 200 spermatozoa, to achieve an acceptably low sampling error.
7. Calculate the proportion of live cells.
8. Report the percentage of vital spermatozoa to the nearest whole number.

### Scoring

- Live spermatozoa have white heads, and dead spermatozoa have heads that are stained red or pink.
- If the stain is limited to only a part of the neck region, and the rest of the head area is unstained, this is considered a "leaky neck membrane", not a sign of cell death and total membrane disintegration. These cells should be assessed as live.

### 2.5.13.2 Vitality test using hypo-osmotic swelling

As an alternative to dye exclusion, the hypo-osmotic swelling test may be used to assess vitality (145). This is useful when staining of spermatozoa must be avoided, e.g. when choosing spermatozoa for intracytoplasmic sperm injection (ICSI). The hypo-osmotic swelling test presumes that only cells with intact membranes (live cells) can swell in hypotonic solutions. Spermatozoa with intact membranes swell within 5 minutes in hypo-osmotic medium, and all flagellar shapes are stabilized by 30 minutes (146).

- Use 30 minutes incubation for routine diagnostics.
- Use 5 minutes incubation when spermatozoa are to be processed for therapeutic use.

### Preparing the reagents

1. Swelling solution for diagnostic purposes: dissolve 0.735 g of sodium citrate dihydrate and 1.351 g of D-fructose in 100 ml of purified water.
  - 1-ml aliquots of this solution can be frozen at  $-20^{\circ}\text{C}$ .
2. For spermatozoa intended for Medically Assisted Reproduction (MAR), dilute the culture medium to be used 1+1 (1 : 2) with appropriate sterile, purified water.

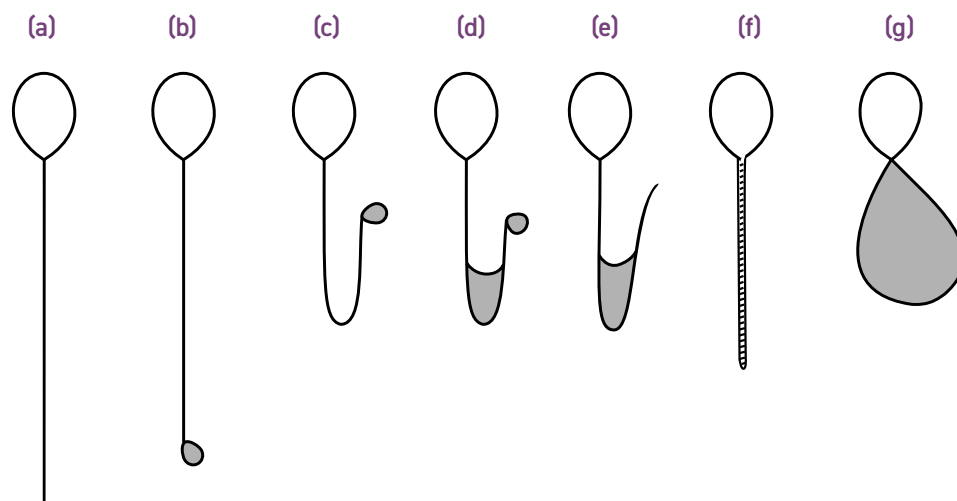
## Procedure

1. Thaw the frozen swelling solution and mix well before use.
2. Warm 1 ml of swelling solution or 1 ml of 1+1 (1 : 2) diluted medium in a closed microcentrifuge tube at 37 °C for 5 minutes.
3. Mix the ejaculate well.
4. Remove a 100- $\mu$ l aliquot of ejaculate and add to the swelling solution. Mix gently by drawing it in and out of the pipette.
5. Incubate at 37 °C for exactly 5 minutes or 30 minutes (see above), then transfer a 10- $\mu$ l aliquot to a clean slide and cover with a 22 mm  $\times$  22 mm coverslip.
6. Remix the semen sample, remove a replicate aliquot, mix with swelling solution, and prepare a replicate slide, as above.
7. Examine each slide with phase contrast optics at  $\times$ 200 or  $\times$ 400 magnification.
8. Tally the number of unswollen (dead) and swollen (vital) cells with the aid of a laboratory counter.
9. Evaluate 200 spermatozoa in each replicate, to achieve an acceptably low sampling error.

## Scoring

1. Swollen spermatozoa are identified by changes in the shape of the cell, as indicated by coiling of the tail (**Fig. 2.16 on page 63**).
2. Live cells are distinguished by evidence of swelling of the sperm tail; score all forms of swollen tails as live spermatozoa.

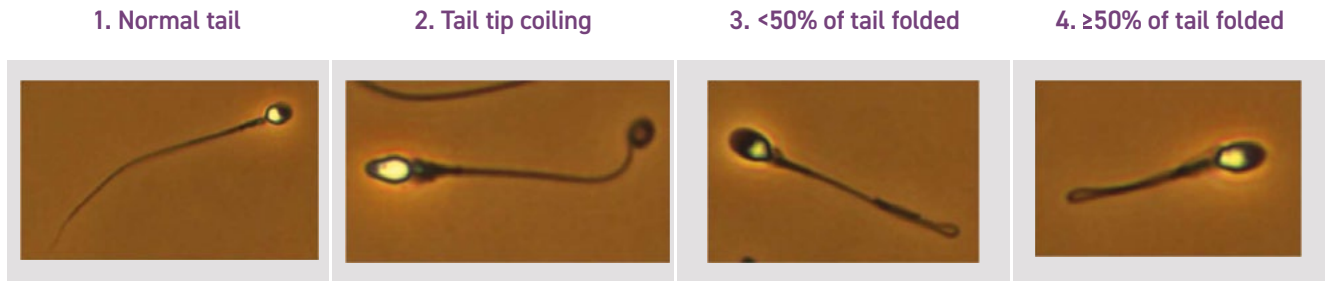
**Fig. 2.17 Schematic representation of typical morphological changes in human spermatozoa subjected to hypo-osmotic stress**



(a) = no change; (b)–(g) = various types of tail changes. Swelling in tail is indicated by the hatched area.

Reproduced from Jeyendran et al. (1984), with permission.

Fig. 2.18 Photo micrographs under phase contrast microscope of spermatozoa subjected to hypo-osmotic stress



Courtesy of E. Holmes (147).

## 2.5.14 Alternative morphology staining techniques

### 2.5.14.1 Shorr stain

The Shorr stain provides similar percentages of normal forms as the Papanicolaou stain, but it has not been validated and evaluated using the strict criteria recommended by WHO (148). Furthermore, the comparisons performed did not evaluate whether the Shorr stain gave the same results as the sperm-adapted Papanicolaou stain.

#### Reagents

1. Harris's haematoxylin (see **Section 8.4.11.3 on page 231**): same as Papanicolaou stain.
2. Shorr solution: buy ready-made or prepare as follows. Dissolve 4 g of Shorr powder in 220 ml of warm 50% (v/v) ethanol. Allow to cool, add 2.0 ml of glacial acetic acid (in fume cupboard) and filter.
3. Acetic ethanol: add 25 ml of glacial acetic acid to 75 ml of 95% (v/v) ethanol.
4. Ammoniacal ethanol: add 5 ml of 25% (v/v) ammonium hydroxide to 95 ml of 75% (v/v) ethanol.

#### Fixing the air-dried ejaculate smear

Immerse slides in acetic-ethanol or 75% (v/v) ethanol for 1 hour.

#### Staining the fixed ejaculate smear

Sequentially immerse the slides in:

- |                       |                         |
|-----------------------|-------------------------|
| 1. running water      | 12–15 dips <sup>7</sup> |
| 2. haematoxylin       | 1–2 minutes             |
| 3. running water      | 12–15 dips              |
| 4. ammoniacal ethanol | 10 dips                 |
| 5. running water      | 12–15 dips              |
| 6. 50% (v/v) ethanol  | 5 minutes               |

<sup>7</sup> One dip corresponds to an immersion of about 1 second.

- 7. Shorr stain 3–5 minutes
- 8. 50% (v/v) ethanol 5 minutes
- 9. 75% (v/v) ethanol 5 minutes
- 10. 95% (v/v) ethanol 5 minutes

Mounting the stained ejaculate smear

The slides can be viewed unmounted or mounted, but mounted slides can be used in training and for IQC and intra-laboratory comparison. In addition, there is no risk of contamination of microscope objectives when slides are properly mounted.

Fig. 2.19 Shorr plate

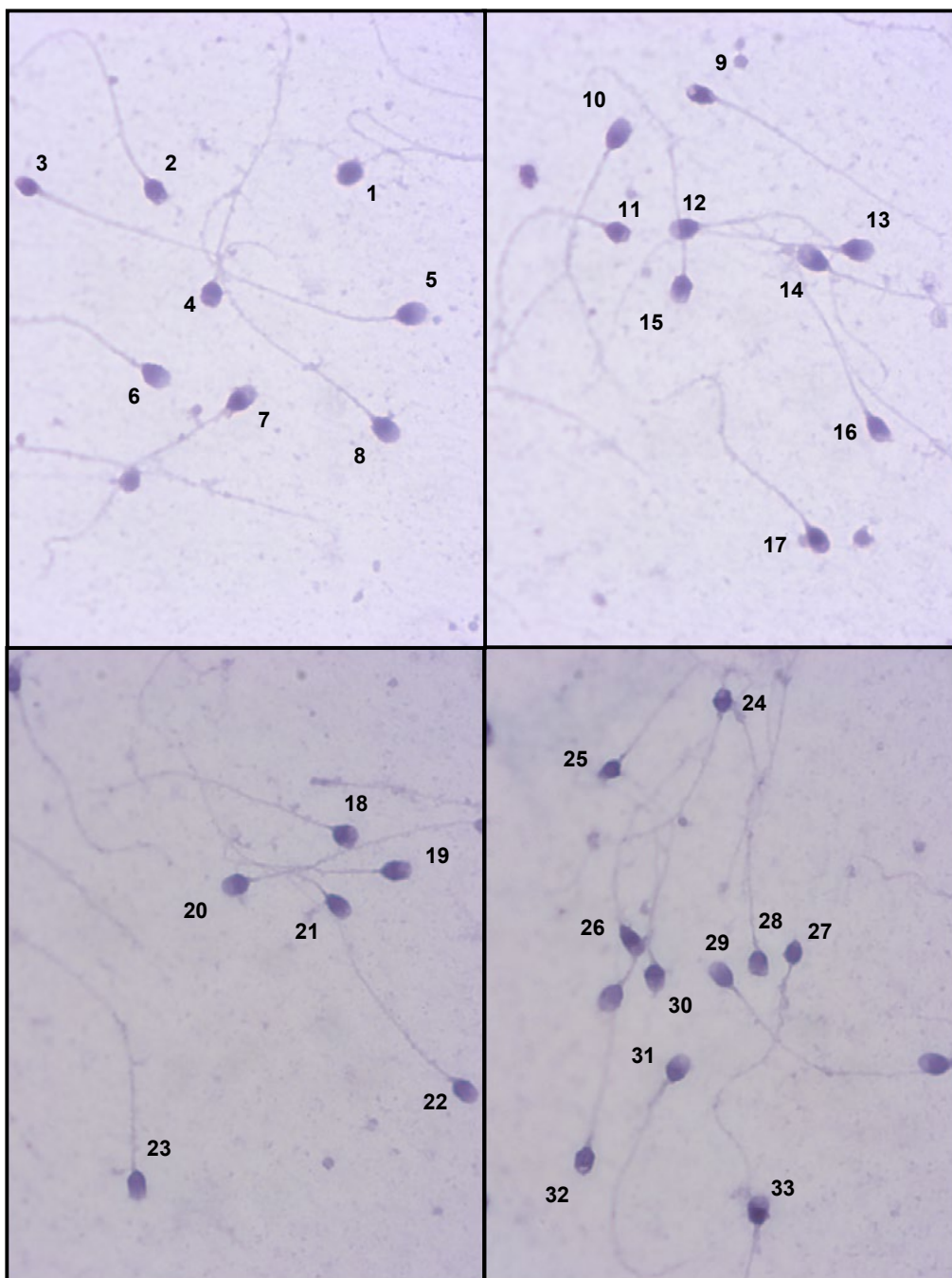


Table 2.14 Shorr plate

	Head shape	Other head comments	Midpiece comments	Principal piece comments	Overall sperm classification
1	abnormal	no acrosome	normal	normal	abnormal
2	abnormal		normal	normal	abnormal
3	abnormal		normal	normal	abnormal
4	abnormal		normal	normal	abnormal
5	normal		normal	normal	normal
6	abnormal		normal	normal	abnormal
7	abnormal		abnormal	normal	abnormal
8	abnormal		normal	normal	abnormal
9	abnormal	too long	normal	normal	abnormal
10	abnormal		normal	normal	abnormal
11	abnormal		normal	normal	abnormal
12	normal		normal	normal	normal
13	abnormal		abnormal	normal	abnormal
14	abnormal		normal	normal	abnormal
15	abnormal		normal	normal	abnormal
16	abnormal		normal	normal	abnormal
17	abnormal		normal	normal	abnormal
18	abnormal		abnormal	normal	abnormal
19	abnormal		normal	normal	abnormal
20	normal		normal	normal	normal
21	abnormal		normal	normal	abnormal
22	abnormal		normal	normal	abnormal
23	abnormal		normal	normal	abnormal
24	abnormal		abnormal	normal	abnormal
25	abnormal		normal	normal	abnormal
26	abnormal		normal	normal	abnormal
27	abnormal		normal	normal	abnormal
28	abnormal		normal	normal	abnormal
29	normal		normal	normal	normal
30	abnormal		abnormal	normal	abnormal
31	abnormal		abnormal	normal	abnormal
32	abnormal		abnormal	normal	abnormal
33	abnormal		abnormal	NA	abnormal

### 2.5.14.2 Rapid staining

Rapid staining methods can be useful when results are necessary the same day. Several differential staining sets are available, and although similar results have been reported (149), other studies have pointed to the need for separate reference limits due to differences in detected abnormalities (150, 151). Some smears stained by rapid procedures have high background staining and may be of lower quality than those stained with Papanicolaou stain. More important, the sizes of the fixed and stained sperm heads differ in comparison with the Papanicolaou staining (152).

#### Reagents

- DiffQuik rapid staining kit
- Fixative: 95% (v/v) methanol alone or 1.8 mg of triarylmethane dissolved in 1000 ml of 95% (v/v) methanol.

#### Fixing the air-dried ejaculate smear

Immerse slides in triarylmethane fixative for 15 seconds or 95% methanol alone for 1 hour. Drain the excess solution by placing slides vertically on absorbent paper.

#### Staining the fixed semen smear

Sequentially immerse the slides in:

1. rapid stain solution 1      10 seconds
2. rapid stain solution 2      5 seconds
3. running tap water          10–15 dips to remove excess stain

Drain the excess solution at each step by placing slides vertically on absorbent paper.

#### Mounting the stained semen

The slides can be viewed unmounted or mounted, but mounted slides can be used in training and for IQC and intra-laboratory comparison. In addition, there is no risk of contamination of microscope objectives when slides are properly mounted.



Fig. 2.20 DiffQuick plate

DiffQuick

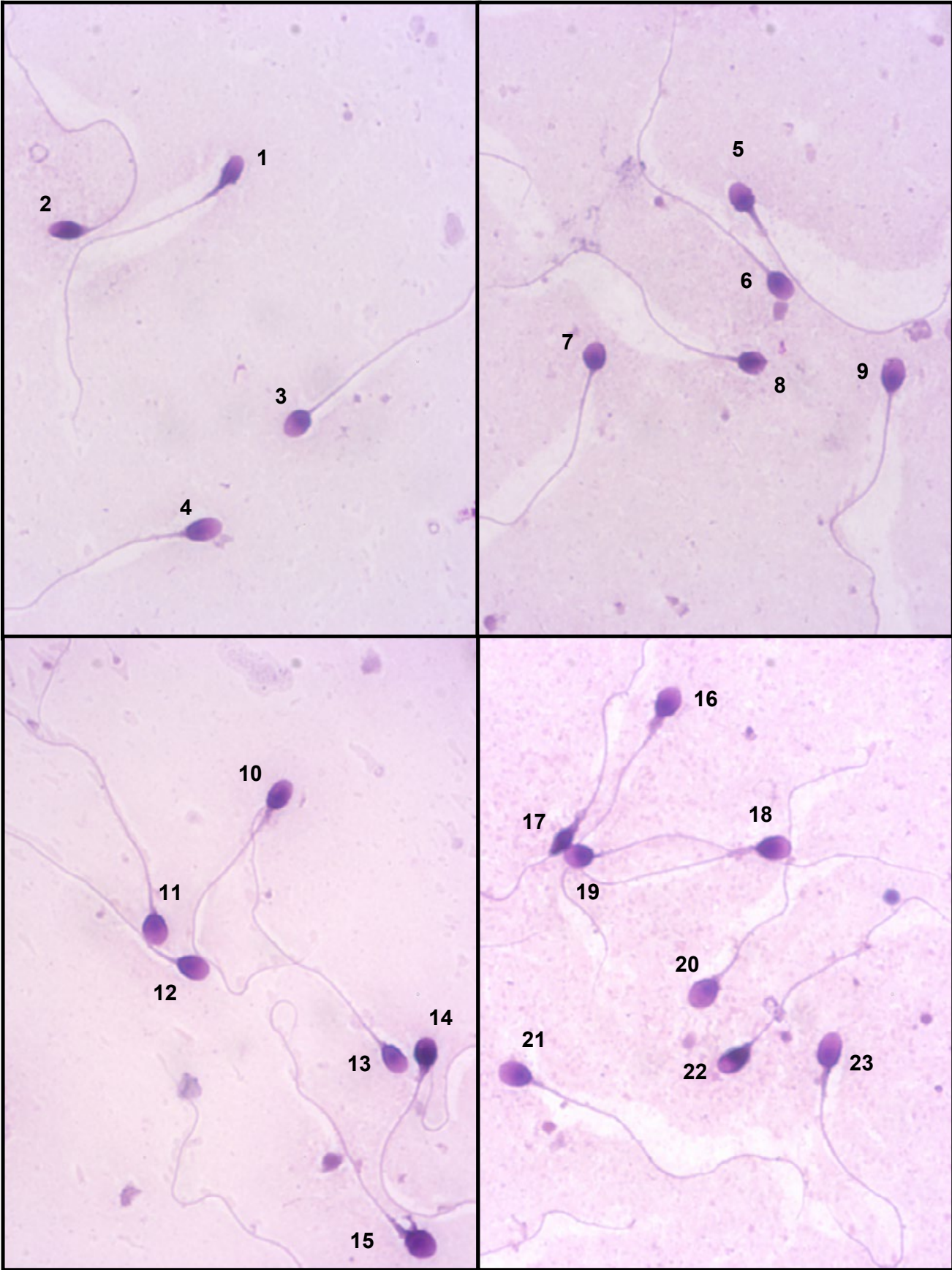


Table 2.15 DiffQuick plate

	Head shape	Other head comments	Midpiece comments	Principal piece comments	Overall sperm classification
1	abnormal		normal	normal	abnormal
2	abnormal		thick	normal	abnormal
3	normal		normal	normal	normal
4	abnormal	not oval	normal	normal	abnormal
5	abnormal	amorphous	thick	normal	abnormal
6	normal		normal	normal	normal
7	abnormal	not oval	normal	normal	abnormal
8	abnormal		normal	normal	abnormal
9	normal		normal	normal	normal
10	abnormal	not oval	thick	normal	abnormal
11	normal		normal	normal	normal
12	normal		normal	normal	normal
13	abnormal	tapered	normal	normal	abnormal
14	abnormal	small	thick	normal	abnormal
15	normal		thick	normal	abnormal
16	abnormal	amorphous	thick	normal	abnormal
17	abnormal	tapered	thick	normal	abnormal
18	normal		asymmetrical	normal	abnormal
19	abnormal	not oval	thick	normal	abnormal
20	normal		normal	normal	normal
21	normal		normal	normal	normal
22	abnormal		normal	normal	abnormal
23	abnormal	not oval	asymmetrical	normal	abnormal

## 2.5.15 Statistical considerations

### 2.5.15.1 Achieving 200 spermatozoa per replicate in the grids of the improved Neubauer chamber

- If there are 10 spermatozoa per HPF of the wet preparation, there would be 2.5/nl and 250/central grid. Diluting the sample 1+1 (1 : 2) would reduce the background and the sperm number to about 125 per grid; assessing a second grid would increase the number to approximately 250, which is sufficient for an acceptable sampling error.
- These calculated concentrations are only rough estimates because so few spermatozoa are counted, and volumes are also very inexact. The concentrations estimated from the undiluted preparations can be between 30% and 130% of the concentrations derived from diluted samples in counting chambers.

### 2.5.15.2 Estimated sampling errors and confidence limits according to total number of spermatozoa counted

- Counting too few spermatozoa will produce an uncertain result, which may have consequences for diagnosis and therapy. This may be unavoidable when spermatozoa are taken for therapeutic purposes and sperm numbers are low.
- When semen volume is small and fewer spermatozoa are counted than recommended, the precision of the values obtained will be significantly reduced. If fewer than 200 spermatozoa are counted per replicate, report the sampling error as given in Table 2.16.
- Sampling error is a measure of the expected error in results based on number of observations. The 95% confidence interval gives upper and lower limits for the range where the true value of the population is, based on the number of observations in the investigated aliquot.

Table 2.16 Rounded sampling errors (%) and 95% confidence interval limits, according to total number of spermatozoa counted

Number of observations (N)	Sampling error (%)	95% Confidence interval limits		Number of observations (N)	Sampling error (%)	95% Confidence interval limits	
		Lower	Upper			Lower	Upper
1	100	0	6	55	13	41	72
2	71	0	7	60	13	46	77
3	58	1	9	65	12	50	83
4	50	1	10	70	12	55	88
5	45	2	12	75	12	59	94
6	41	2	13	80	11	63	100
7	38	3	14	85	11	68	105
8	35	3	16	90	11	72	111
9	33	4	17	95	10	77	116
10	32	5	18	100	10	81	122
15	26	8	25	150	8	127	176
20	22	12	31	200	7	173	230
25	20	16	37	250	6	220	283
30	18	20	43	300	6	267	336
35	17	24	49	350	5	314	389
40	16	29	54	400	5	362	441
45	15	33	60	450	5	409	494
50	14	37	66	500	4	457	546

### 2.5.15.3 Errors in estimating percentages

How certain an estimate of a percentage is depends not only on the number (N) of spermatozoa counted but also on the true, but unknown, percentage ( $p$ ) (binomial distribution). The approximate standard error (SE) is  $\sqrt{(p(100-p))/N}$  for percentages between 20 and 80. Outside this range, a more appropriate method to use is the angular transformation (arc sin square root),  $z = \sin^{-1}\sqrt{p/100}$ , with a standard deviation of  $1/(2\sqrt{N})$  radians, which depends only on the number of spermatozoa counted and not the true percentage.

### 2.5.15.4 Comparison of replicate percentages

A larger than acceptable difference between replicates suggests that there has been miscounting or errors of pipetting, or that the cells were not mixed well, with non-random distribution in the chamber or on the slide. With these 95% confidence interval cut-off values, approximately 5% of replicates will be outside the limits by chance alone. Exact binomial confidence limits can now be computer-generated, and these are used in this manual, rounded off to ascertain that assumed probabilities, e.g. "less than 5%", are correct.

### 2.5.15.5 Importance of counting sufficient numbers of spermatozoa

To reduce the influence of random variation, it is important that assessments are based on sufficient numbers of observations (preferably a total of at least 400, from replicate counts of approximately 200) (**Table 2.16 on page 78**). The precision of the estimate of sperm number depends on the number of spermatozoa counted. In a Poisson distribution, the SE of a count ( $N$ ) is its square root ( $\sqrt{N}$ ), and the 95% confidence interval (CI) for the number of spermatozoa in the volume of semen is approximately  $N \pm 1.96 \times \sqrt{N}$  (or  $N \pm$  approximately  $2 \times \sqrt{N}$ ).

If 100 spermatozoa are counted, the SE is 10 ( $\sqrt{100}$ ), and the 95% CI is 80–120 ( $100 \pm 20$ , or 20%). If 200 spermatozoa are counted, the SE is 14 ( $\sqrt{200}$ ), and the 95% CI is 172–228 ( $200 \pm 28$  or 14%). If 400 spermatozoa are counted, the SE is 20 ( $\sqrt{400}$ ), and the 95% CI is 360–440 ( $400 \pm 40$  or 10%).

It should be noted that with a cut-off of 4% for ideal forms, it would be necessary to assess more than 1500 spermatozoa to be able to state that 3% and 5% are different.

### 2.5.15.6 Statistical theory behind comparisons of replicate counts

The difference between independent counts is expected to be zero, with an SE equal to the square root of the sum of the two counts. Thus  $(N1 - N2) / (\sqrt{N1 + N2})$  should be  $< 1.96$  by chance alone for a 95% CI.

If the difference between the counts is less than or equal to that indicated in **Table 2.3 on page 33** for the given sum, the estimates are accepted, and the concentration is calculated from their mean (**Table 2.4 on page 35**).

Larger differences suggest that either miscounting has occurred, there were errors of pipetting, or the cells were not well mixed, resulting in non-random distribution in the chamber or on the slide.

When the difference between the counts is greater than acceptable, discard the first two values, and prepare and assess two fresh dilutions of semen. (Do not count a third sample and take the mean of the three values or take the mean of the two closest values.)

This applies to counts of spermatozoa and peroxidase-positive cells (**Section 3.4.1.1 on page 108**). For CD45-positive cells (**Section 3.4.2 on page 113**) and immature germ cells (**Section 3.6 on page 118**), the stained preparations should be reassessed.

With these 95% CI cut-off values, approximately 5% of replicates will be outside the limits by chance alone.

### 2.5.16 Sperm measures

An eyepiece micrometer may be useful for distinguishing between normally and abnormally sized sperm heads.

The head dimensions of 77 Papanicolaou-stained spermatozoa classified as normal by the criteria given here and measured by a computerized system (coefficient of variation for repeated measurements 2–7%) had the following dimensions: median length 4.1  $\mu\text{m}$ , 95% CI 3.7–4.7  $\mu\text{m}$ ; median width 2.8  $\mu\text{m}$ , 95% CI 2.5–3.2  $\mu\text{m}$ ; median length-to-width ratio 1.5, 95% CI 1.3–1.8.

The midpieces of 74 Papanicolaou-stained spermatozoa classified as normal by the criteria given here and measured by the same computerized system had the following dimensions: median length 4.0  $\mu\text{m}$ , 95% CI 3.3–5.2  $\mu\text{m}$ ; median width 0.6  $\mu\text{m}$ , 95% CI 0.5–0.7  $\mu\text{m}$ .

### 2.5.17 Worked examples

#### 2.5.17.1 Calculating concentration of other items

The concentrations of other cells and, for instance, parts of spermatozoa (headless tails, tailless heads) can be calculated by relating to the sperm concentration. Provided the presence of the items has been counted in the same volume (HPF) as spermatozoa were counted, the following formula can be used:

$$C = S \times N_i / N_s$$

Where

C = the concentration of other cells, cell parts or other items of interest

S = calculated sperm concentration

$N_i$  = the number of counted other cells, cell parts or other items

$N_s$  = the number of spermatozoa counted in the same volume (area) as the wanted items.

#### 2.5.17.2 Percentages of spermatozoa with normal morphology and TZI

Of 200 spermatozoa scored with a 6-key counter, 12 spermatozoa are scored as normal and 188 as abnormal. Of the 188 abnormal spermatozoa, 184 have head defects, 102 have midpiece defects, 30 have principal piece defects, and 44 have excess residual cytoplasm.

- normal forms  $12/200 = 6\%$
- abnormal heads  $184/200 = 91\%$
- abnormal neck/midpieces  $102/200 = 51\%$
- abnormal tail  $30/200 = 15\%$
- percentage with excess residual cytoplasm  $44/200 = 22\%$
- TZI  $(184+102+30+44)/188 = 1.91$ .

### 2.5.17.3 Calculation of sperm parts or non-sperm cells in morphology smears

C = the wanted concentration of other cells, cell parts or other items

N = number of non-sperm cells or sperm parts counted in the same number of fields as 200 spermatozoa

S = concentration of spermatozoa in millions per ml

$C = S \times (N/200)$  in millions per ml can be calculated from the formula.

### 2.5.17.4 Sperm concentration

#### Example 1

With a 1+1 (1 : 2) dilution, replicate 1 is found to contain 200 spermatozoa in 2 grids, while replicate 2 contains 250 spermatozoa in 2 grids. The sum of the values (200+250) is 450 in 4 grids, and the difference (250–200) is 50. From **Table 2.3 on page 33** this is seen to exceed the limit difference (41), expected by chance alone, so the results are discarded, and two new replicate dilutions are made.

#### Example 2

With a 1+1 (1 : 2) dilution, replicate 1 is found to contain 219 spermatozoa in 3 grids, while replicate 2 contains 180 spermatozoa in 3 grids. The sum of the values (219+180) is 399 in 6 grids, and the difference (219–180) is 39. From **Table 2.3 on page 33** this is seen to be equal to the limit difference (39), so less than that found by chance alone, so the values are accepted.

The concentration of spermatozoa in the sample for a 1+1 (1 : 2) dilution is  $C = (N/n)/50$  spermatozoa/nl or  $(410/6)/50 = 1.37$  spermatozoa/nl, or  $1.4 \times 10^6$  spermatozoa/ml of semen (to two significant figures).

#### Example 3

With a 1+1 (1 : 2) dilution, replicate 1 is found to contain 120 spermatozoa in all 9 grids, while replicate 2 contains 140 spermatozoa in all 9 grids. The sum of the values (120+140) is 260 in 18 grids, and the difference (140–120) is 20. From **Table 2.3 on page 33** this is seen to be less than the limit difference (31), so the values are accepted.

When all nine grids are assessed in each chamber (a total of 1.8  $\mu$ l), the concentration of spermatozoa in the sample for a 1+1 (1 : 2) dilution is  $C = (N/1.8) \times 2$  spermatozoa per  $\mu$ l =  $(260/1.8) \times 2 = 288.8$  spermatozoa/ $\mu$ l, or  $290 \times 10^3$  spermatozoa per ml of semen (to two significant figures). As fewer than 400 spermatozoa were counted, report the sampling error for 260 spermatozoa as given in Table 2.3 (approximately 6.3%).

#### Example 4

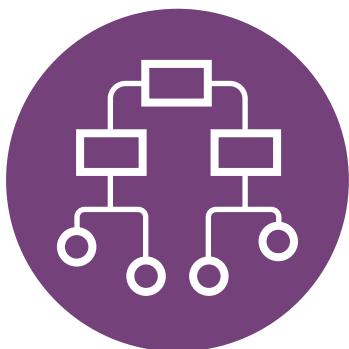
With a 1+1 (1 : 2) dilution, replicate 1 was found to contain 10 spermatozoa in all 9 grids, while replicate 2 contained 8 spermatozoa in all 9 grids. As fewer than 25 spermatozoa are found in all 9 grids, the concentration is < 56 000/ml; report that "18 spermatozoa were seen in the samples, too few for accurate determination of concentration (< 56 000/ml)".

#### Example 5

With a 1+1 (1 : 2) dilution, no spermatozoa are found in either replicate. As fewer than 25 spermatozoa were counted, the concentration is < 56 000/ml; report that "No spermatozoa were seen in the replicates, too few for accurate determination of concentration (< 56 000/ml)".







## Chapter 3: Extended examination

3.1 Indices of multiple sperm defects.....	83
3.2 Sperm DNA fragmentation.....	86
3.3 Genetic and genomic tests.....	105
3.4 Tests related to immunology and immunological methods.....	108
3.5 Assessment of interleukins – marker of male genital tract inflammation.....	116
3.6 Assessment of immature germ cells in the ejaculate.....	118
3.7 Testing for antibody coating of spermatozoa.....	119
3.8 Biochemical assays for accessory sex gland function.....	125
3.9 Assessment of sequence of ejaculation.....	135

The tests described in this chapter are not necessary for routine semen analysis but may be useful in certain circumstances for diagnostic or research purposes. Some publications may indicate the usefulness of a test based on a high coefficient of correlation. However, even with high coefficients of correlation, to evaluate if a test is useful for the individual man, the positive and negative predictive values must be considered (measurements of probabilities that a positive or negative result is true, respectively).

Some tests included here were described following the recommended standard tests. For the sake of standardization and clarity of recommendations, alternative tests were moved to this chapter. It is acceptable for laboratories to consider using such tests to replace recommended basic examinations, as long as the relationship to the basic examinations is established and explained.

“

Clinically, there is growing awareness that chromosomal anomalies and gene mutations underlie a diverse spectrum of male infertility that underlie many of the anomalies seen in a semen analysis.

”

### 3.1 Indices of multiple sperm defects

Morphologically abnormal spermatozoa often have multiple defects (of the head, midpiece or principal piece, or combinations of these defects). A detailed assessment of the incidence of morphological abnormalities may be more useful than a simple evaluation of the percentage of morphologically normal spermatozoa, especially



in studies of the extent of damage to human spermatogenesis (58, 153). Recording the morphologically normal spermatozoa, as well as those with abnormalities of the head, midpiece and principal piece, in a multiple-entry system gives the mean number of abnormalities per spermatozoon assessed.

Three indices can be derived from records of the detailed abnormalities of the head, midpiece and principal piece in a multiple-entry system:

- the teratozoospermia index (TZI) (104, 154) (as recommended in Chapter 2);
- the multiple anomalies index (MAI) (58);
- the sperm deformity index (SDI) (155-157).

These indices have been correlated with fertility in vivo (MAI and TZI) (58, 104) and in vitro (SDI) (155), and may be useful in assessments of certain exposures or pathological conditions (153, 156, 157).

### 3.1.1 Calculating indices of multiple morphological defects

Each abnormal spermatozoon is scored for defects of the head, midpiece and principal piece, and for the presence of excess residual cytoplasm (volume more than one third of the sperm head size). Laboratory cell counters can be used, with the number of entry keys adapted to the type of index being assessed. If a counter is not available, a simple score sheet can be used.

- The TZI has a maximum of four defects per abnormal spermatozoon: one each for head, midpiece and principal piece, and one for excess residual cytoplasm. The morphological criteria given in this manual can be used (See also **Microscopic assessment and calculation of results on page 54**).
- The MAI is similar to the TZI, as it is based on the mean number of anomalies per abnormal spermatozoon. All the head, midpiece and principal piece anomalies are included in the calculation. The morphology criteria used for this analysis are from (158) as modified by (159), and differ from those presented in this manual (**Section 2.4.9 on page 41**).
- The SDI is the number of defects divided by the total number of spermatozoa (not only the abnormal spermatozoa). It incorporates several categories of head anomaly but only one for each midpiece and principal piece defect. The morphological criteria given in this manual can be used.

Table 3.1 shows an example of the calculations involved in generating these indices, to demonstrate the differences between them.

Table 3.1 Calculation of indices of multiple sperm defects

	MAI	TZI	SDI
Maximum value		4.00	3.00
Denominator	abnormal sperm	abnormal sperm	all sperm
(A) No. of spermatozoa counted	200	200	200
normal spermatozoa (N)	46	46	46
normal spermatozoa (%)	23	23	23
(B) No. of spermatozoa with defects (200–46)	154	154	154
(1) No. of head defects (MAI, SDI) or number of spermatozoa with > 1 head defect (TZI)	284	154	212
(2) No. of midpiece defects (MAI) or number of spermatozoa with ≥ 1 midpiece defect (TZI, SDI)	54	52	52
(3) No. of principal piece defects (MAI) or number of spermatozoa with ≥ 1 principal piece defect (TZI, SDI)	54	46	46
(4) No. of spermatozoa with excess residual cytoplasm	14	14	14
(C) Total defects (1)+(2)+(3) (= C) (MAI)	392		
(D) Total defects (1)+(2)+(3)+(4) (= D) (TZI, SDI)		266	324
Index calculation	C/B	D/B	D/A
Index value	2.55	1.72	1.62



**Note:** This description of the TZI is in accordance with that in the original paper by Menkveld et al. (104) and the manual of the European Society of Human Reproduction and Embryology (12) and the Nordic Association for Andrology (160), which give values ranging from 1.00 to 4.00. This is different from the description in a previous edition of this manual (4), in which excess residual cytoplasm was not recorded separately, and which gave TZI values ranging from 1.00 to 3.00. Interpretation

### 3.1.2 Interpretation

Table 3.2 presents values for MAI and TZI for men attending infertility clinics and men who had fathered a child within the last three years. It should be noted that there is an overlap between fertile men and men in subfertile couples, meaning that also regarding these measures, no sharp limit exists between fully fertile and subfertile men.

It should, however, be remembered that prognosis of spontaneous or assisted fertilization is not the only use for assessment of human sperm morphology. Disturbance of spermatogenesis in men with quantitative ordinary sperm production gives further information, and can point to testicular stress, epididymal malfunction or even genetic sperm tail disorders. In the latter case, any hormonal stimulation is not likely to be successful, and the couple could be offered a clinical genetic investigation to understand the risk of disorders in the offspring.



The differences noted for the sperm defect indices for male partners of fertile and infertile couples are small, making it difficult to use these criteria to attempt to distinguish these groups with these indices. Using a somewhat different system for grading, multiple morphological anomalies of the flagella (MMAF) (161) reviewed in Coutton, et al., (162), morphogenic deficiencies are associated with a series of genetic defects affecting sperm function.

**Table 3.2 Sperm defect indices for men from fertile and infertile couples**

	Infertile couples		Fertile couples	
	MAI <sup>a</sup>	TZI <sup>b</sup>	MAI <sup>c</sup>	TZI <sup>b</sup>
<b>Mean</b>	<b>1.94</b>	<b>1.81</b>	<b>1.58</b>	<b>1.51</b>
<b>Standard deviation</b>	<b>0.37</b>	<b>0.30</b>	<b>0.20</b>	<b>0.20</b>
<b>Minimum</b>	<b>1.12</b>	<b>1.26</b>	<b>1.04</b>	<b>1.17</b>
<b>Maximum</b>	<b>3.9</b>	<b>2.64</b>	<b>2.38</b>	<b>2.07</b>
<b>Percentiles</b>				
<b>5</b>	<b>1.44</b>		<b>1.27</b>	
<b>10</b>	<b>1.51</b>	<b>1.74</b>	<b>1.34</b>	<b>1.33</b>
<b>25</b>	<b>1.67</b>		<b>1.44</b>	
<b>50</b>	<b>1.88</b>	<b>1.81</b>	<b>1.58</b>	<b>1.54</b>
<b>75</b>	<b>2.14</b>		<b>1.72</b>	
<b>90</b>	<b>2.44</b>		<b>1.86</b>	
<b>95</b>	<b>2.65</b>		<b>1.94</b>	
<b>N</b>	<b>4 930</b>	<b>103</b>	<b>994</b>	<b>107</b>

<sup>a</sup> Unpublished data from J. Auger, Paris, using David's morphological classification (158), modified by Auger & Eustache (2000) (159).

<sup>b</sup> Menkveld et al. (2001) (104).

<sup>c</sup> Jorgensen et al. (2001) (163), using David's morphological classification (158); modified by Auger & Eustache (2000) (159)

## 3.2 Sperm DNA fragmentation

### 3.2.1 Background

Sperm DNA damage can be defined as any chemical change in the normal structure of the DNA. Among these changes, sperm DNA fragmentation (sDF) is one of the most common disturbances affecting the genetic material in the form of single or double strand breaks. sDF may be triggered by different processes, including the defective packaging of the DNA during spermatogenesis, and processes of cell death and oxidative stress which may be associated with several pathological and environmental conditions (164-166).

Although the fertilization capacity of spermatozoa containing sDF may not be impaired, multiple meta-analyses published in recent years indicate that it may affect embryo development, implantation, and pregnancies in both natural and assisted reproduction (167-170). It is also known that sDF is prevalent among men with abnormal ejaculate parameters, and it has been proposed to be related to cases of infertility in normozoospermic individuals. Since sDF is only partially related to semen quality (164, 171), it could represent an important addition in the work-up of male infertility, becoming one of the most discussed and promising biomarkers in basic and clinical andrology.

Several methods have been developed to test sDF by making their way into the sperm chromatin to assess the presence of DNA fragmentation (i.e. the occurrence of single or double DNA strand breaks). Those presented here have been widely used in the last 20 years in andrology and assisted reproduction laboratories.

Assays that can be used to evaluate sDF vary greatly in both the method and the type of damage they are detecting. Terminal deoxynucleotidyl transferase (dUTP) nick end labelling (TUNEL) and single cell gel electrophoresis (Comet) assays directly assess the presence of single and/or double strand breaks in the DNA, whereas acridine orange flow cytometry (AO FCM) and sperm chromatin dispersion test (SCD) assays detect the susceptibility of chromatin to treatment by acid.

The diagnostic thresholds (also called cut-off values) of these methods will be specific to each assay and method by which it was performed. For clinical use, the appropriate thresholds should be determined and validated by the performing laboratory. For the usefulness for the individual patient, it is important that not only population correlations are studied; data on positive and negative predictive values are warranted to evaluate and validate the usefulness in actual clinical practice.

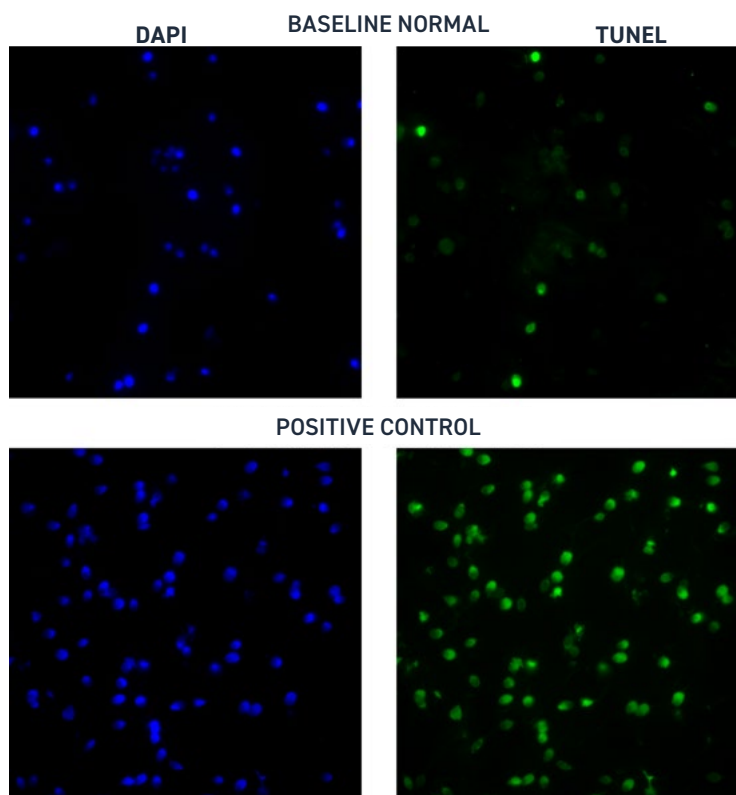
### 3.2.2 TUNEL assay

The TUNEL assay is another of the most common techniques for the assessment of sperm DNA fragmentation. The assay relies on detection of DNA strand breaks in situ by labelling them with fluorochromes or with biotin-tagged probes to be used with streptavidin-HRP (horseradish peroxidase) and a chromogenic HRP substrate. The principle of TUNEL is to label the breaks present in DNA with deoxynucleotides (usually deoxyuridine triphosphate, dUTP). The dUTP could be directly conjugated to a fluorescent dye or tagged by biotin.

The 3'-OH-termini of the DNA strand breaks serve as primers and become labelled in this procedure with bromo deoxyuridine (Brd-U) in a reaction catalysed by a template-independent DNA polymerase called Terminal deoxynucleotidyl Transferase (TDT) (172). The method is capable of directly assessing both single and double strand breaks, thus the more DNA strand break sites present, the more label is incorporated within a cell. d-UTP is the substrate that is added by the TDT enzyme to the free 3'-OH-termini. The added d-UTP can be directly labelled and therefore acts as a direct marker of DNA breaks, or the signal can be amplified by the use of a modified d-UTP to which labelled anti-d-UTP antibody can be adsorbed (not only d-UTP but other deoxynucleotides can be used)(173).

**Fig. 3.1 TUNEL slide assay for DNA fragmentation using fluorescence**

The upper panels show the DAPI-stained sperm (blue) and the fluorescently stained (green) sperm with DNA damage, showing the baseline level of damage; the lower panels represent a positive control where virtually all sperm shown (blue) exhibit DNA fragmentation based on their green fluorescence.



Photos provided by Drs. C. Roman-Montanana and J. Kirkman-Brown.

There are several commercial kits that provide tagged probes and the enzyme TDT necessary to bind the probe to the DNA breaks. After labelling, the percentage of fluorescent spermatozoa can be determined by fluorescent microscopy or a flow cytometer. In the case of biotin-tagged probes, streptavidin-HRP (horseradish peroxidase) and a chromogenic HRP substrate are necessary to reveal marked spermatozoa. The cells stained with this method can be visualized microscopically for their evaluation (Fig. 3.1); however, for a high-throughput assessment of clinical semen samples, TUNEL can be used coupled with flow-cytometry, with which a quantitative assessment of the proportion of genetically compromised cells within a semen sample is possible.

When using a microscope, at least 200 spermatozoa should be scored. It has been reported that variations in the different steps of the TUNEL assay may greatly affect the obtained measures (174). Thus, it is important that each laboratory standardizes the technique and sets its own cut-off values.

### 3.2.2.1 Primary method

#### Reagents

- Human tubal fluid or Biggers, Whitten and Whittingham (see **appendix on page 229** for composition; HTF, BWW)



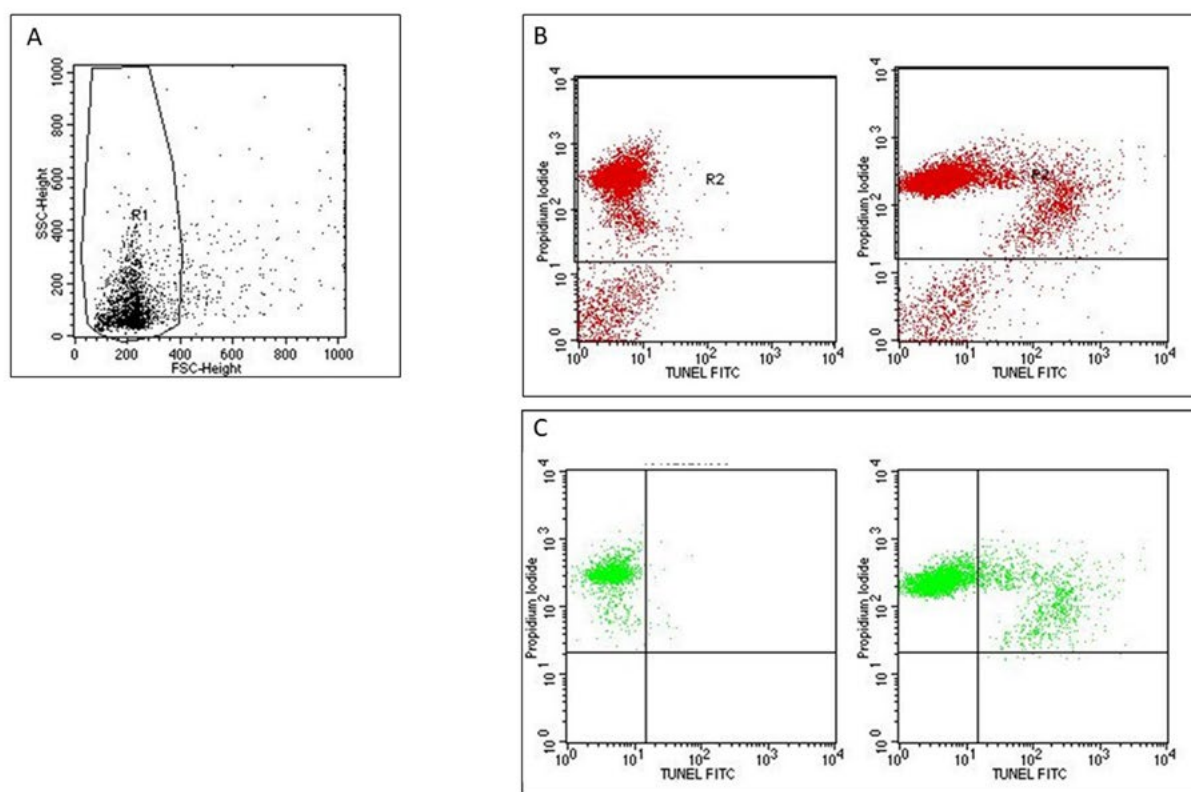
- Dulbecco's phosphate-buffered saline (see **appendix on page 227** for composition; DPBS)
- DPBS containing 1% bovine serum albumin (BSA)
- DPBS containing 0.1% citrate and 0.1% triton
- 3.7% paraformaldehyde prepared in DPBS every week
- 3000 U/ml–3 U/ml micrococcal nuclease or recombinant deoxyribonuclease (DNase) I in 50 mm Tris-HCL, pH 7.5, 1 mg/ml BSA.

#### Procedure

1. An aliquot of semen, containing at least 2 million (for samples with a low sperm number) but preferably 10 million spermatozoa, is washed twice with a buffer (HTF or BWW, see appendix for composition; for samples below 2 million, fluorescent microscopy can be used instead and the percentage of TUNEL-positive spermatozoa assessed) by centrifuging at 500g for 5 minutes. For samples with a sperm number below 2 million, after the staining procedure, TUNEL-positive spermatozoa can be scored as reported in the section on **TUNEL coupled to fluorescence microscopy on page 92**.
2. The pellet is resuspended in 500µl of paraformaldehyde (3.7% freshly prepared in DPBS every week) for fixation at room temperature for 30 minutes.
3. Centrifuge at 500g for 5 minutes and wash the pellet twice in 200µl of DPBS containing 1% BSA as above.
4. To permeabilize spermatozoa, add 100µl of buffer containing citrate (0.1%) and triton (0.1%), and incubate on ice for 4 minutes.
5. To stop permeabilization, add 300µl of DPBS containing 1% BSA and centrifuge at 500g for 5 minutes.
6. Remove supernatant and resuspend the pellet with 400µl of DPBS containing 1% BSA and divide into two aliquots, respectively negative control (TDT-) and test sample (TDT+).
7. A positive control may be useful to demonstrate that the procedure can recognize fragmented DNA. In this case, another aliquot of spermatozoa should be prepared as above, and, after permeabilization, it is incubated with micrococcal nuclease or DNase I recombinant (3000 U/ml–3 U/ml in 50 mm Tris-HCL, pH 7.5, 1 mg/ml BSA) for 10 minutes at 15–25 °C to induce DNA strand breaks, prior to labelling procedures.
8. Centrifuge the three aliquots (at 500g for 5 minutes) and resuspend as follows: TDT-: add only the buffer containing the labelled probe; TDT+ and positive control: add the buffer containing the labelled probe and TDT (30 units or otherwise indicated in the different commercial kits).
9. Incubate (in case of fluorescent probes in the dark) for 1 hour at 37 °C.
10. Wash twice with 200 µl of DPBS containing 1% BSA and resuspend in DPBS. The final DPBS volume varies depending on the method used to reveal the labelled probe. When using a microscope, a small volume (maximum 100 ul) should be used to set up slides with a sufficient number of spermatozoa to be observed under fluorescent or light microscopy. At least 200 spermatozoa should be scored.

11. In case of detection by a flow cytometer, samples should be washed twice, resuspended in 500  $\mu$ l of DPBS, stained with Propidium Iodide (PI, 30  $\mu$ g/ml in DPBS) or another nuclear staining compatible with the fluorescence of TUNEL and incubated in the dark for 10 minutes at room temperature to identify nucleated events. For each sample, 8000–10 000 PI positive events must be recorded within the region containing spermatozoa (flame-shaped region (174) drawn in the forward light scatter/side light scatter (FSC/SSC) dot plot (R1 in Fig. 3.2A), to exclude other cells (such as germ cells, leukocytes which are outside the flame) and interferences present in the ejaculate (including PI negative events such as apoptotic bodies that may be present within R1 (174, 175). Green fluorescence (of nucleotides conjugated with fluorescein) and red fluorescence (PI events) are revealed respectively by 515–555 nm and 563–607 wavelength band detectors. An R2 region is then drawn to include all PI positive events within the R1 region (Fig. 3.2B, left and right panels). A threshold for DNA fragmentation fluorescence (TUNEL-positive spermatozoa) is set in the negative control, including 99% of the PI positive events (Fig. 3.2C, left panel). This threshold is then copied in the test sample (Fig. 3.2C, right panel) to calculate the percentage of PI- and green fluorescence-positive events beyond the threshold, representing the percentage of spermatozoa with DNA fragmentation.

Fig. 3.2 Flow cytometry for analysis of Propidium Iodide and green fluorescence



Courtesy of Elisabetta Baldi

**In Panel A**, the typical flame-shaped region in the FSC/SSC dot plot containing spermatozoa and apoptotic bodies (R1). **Panel B**, a gate around PI positive events is drawn (R2), excluding apoptotic bodies. **Panel C**, left: negative control where a marker is set, including 99% of negative events. Panel C, right: test sample where the markers set in the negative control are translated. The percentage of spermatozoa with DNA fragmentation is located in the upper right quadrant.



### 3.2.2.2 Alternative TUNEL procedure

Adapted from Darzynkiewicz et al. (176) and Sharma et al. (173)

#### Reagents

- Phosphate-buffered saline (**DPBS**), pH 7.4
- 1–3.7% (v/v) formaldehyde in DPBS
- 70% ethanol, pH 7.4
- TDT 5X reaction buffer: 1 M potassium (or sodium) cacodylate, 125 mM HCl, pH 6.6, 1.25 mg/ml BSA
- Br-dUTP stock solution: 2 mM Br-dUTP in 50 mM Tris-HCl, pH 7.5
- 12.5 units of TDT: supplied in storage buffer: 60 mM potassium phosphate at pH 7.2, 150 mM KCl, 1 mM 2-mercaptoethanol and 0.5% Triton X-100, 50% glycerol
- 10 mM CoCl<sub>2</sub>
- Distilled H<sub>2</sub>O
- 0.1% Triton X-100 and 5 mg/ml BSA dissolved in DPBS
- Fluorescein isothiocyanate (FITC)-(or Alexa Fluor 488)-conjugated anti-Br-dU mAb solution: 0.1–0.3 µg of the fluorochrome-conjugated anti-Br-dU Ab in 100 µl of DPBS containing 0.3% Triton X-100 and 1% (w/v) BSA
- PI staining solution: 5 µg/ml PI, 100 µg/ml of RNase A (DNase-free) in DPBS.

#### Protocol

1. Suspend 1–5×10<sup>6</sup> spermatozoa in 0.5 ml of DPBS, pH 7.4.
2. Transfer this suspension with a Pasteur pipette into a 5 ml polypropylene tube containing 4.5 ml of ice-cold 1–3.7% (v/v) formaldehyde in DPBS, pH 7.4. Keep the tube on ice for 30–60 minutes.
3. Centrifuge at 300g for 5 minutes and resuspend the sperm pellet in 5 ml of DPBS.
4. Centrifuge again at 300g for 5 minutes and resuspend the sperm pellet in 0.5 ml of DPBS.
5. Transfer the suspension to a tube containing 4.5 ml of ice-cold 70% ethanol, pH 7.4, and perform this step using again a Pasteur pipette. If it is necessary or convenient, the sperm suspension can be stored in ethanol for several weeks at –20 °C.
6. Centrifuge at 200g for 3 minutes to remove the ethanol, and resuspend the spermatozoa in 5 ml of DPBS.
7. Centrifuge again at 300g for 5 minutes, and resuspend the pellet in 50 µl of a solution containing:
  - 10 µl TDT 5X reaction buffer: 1 M potassium (or sodium) cacodylate, 125 mM HCl, pH 6.6, 1.25 mg/ml BSA



- 2.0 µl of Br-dUTP stock solution: 2 mM Br-dUTP in 50 mM Tris-HCl, pH 7.5
  - 0.5 µl (12.5 units) of TDT: supplied in storage buffer: 60 mM potassium phosphate at pH 7.2, 150 mM KCl, 1 mM 2-mercaptoethanol and 0.5% Triton X-100, 50% glycerol
  - 5 µl of 10 mM CoCl<sub>2</sub>
  - 33.5 µl of distilled H<sub>2</sub>O.
8. Incubate the cells in this solution for 40 minutes at 37 °C.
  9. After the incubation time, add 1.5 ml of the rinsing buffer: 0.1% Triton X-100 and 5 mg/ml BSA dissolved in DPBS, and centrifuge at 300g for 5 minutes.
  10. Resuspend cell pellet in 100 µl of FITC-(or Alexa Fluor 488)- conjugated anti-Br-dU mAb solution: 0.1–0.3 µg of the fluorochrome-conjugated anti-Br-dU Ab in 100 µl of DPBS containing 0.3% Triton X-100 and 1% (w/v) BSA.
  11. Incubate at room temperature for 1 hour.
  12. Add 1 ml of PI staining solution: 5 µg/ml PI, 100 µg/ml of RNase A (DNase-free) (Sigma) in DPBS.
  13. Incubate in the dark for 30 minutes at room temperature or 20 minutes at 37 °C.

### 3.2.2.3 Results

#### TUNEL coupled to flow cytometry

Analyse cells by flow cytometry using a blue light 488 nm laser. Measure green fluorescence of FITC-(or Alexa Fluor 488)-anti-Br-dU Ab at 530/20 nm. Measure red fluorescence of PI at > 600 nm.

#### TUNEL coupled to fluorescence microscopy

1. Load an aliquot of the stained sample on a slide and cover with a coverslip.
2. Score a minimum of 500 spermatozoa per sample under 40× objective with an epifluorescence microscope (excitation between 460 and 490 nm and an emission > 515 nm).
3. First count the number of spermatozoa per field stained with PI (red).
4. Count the number of cells emitting green fluorescence (TUNEL-positive) in the same field.
5. Calculate the percentage of TUNEL-positive cells.

### 3.2.2.4 Clinical interpretation

TUNEL can be performed in multiple ways. Depending on the protocol used, different laboratories have reported differing limits that have been used to discriminate between a healthy semen sample and those correlated with male infertility (164,

173, 177-179). Therefore, every lab should establish its own reference range using appropriate controls, based on positive and negative predictive values, and be clear what the predictive value relates to (e.g. conception, miscarriage or other phenomena).

### 3.2.2.5 Technical notes

- To prevent the extraction of highly fragmented DNA during the repeated washings during the procedure, prefixation with a crosslinking agent such as formaldehyde is a critical step for the success of the assay. Freshly prepared formaldehyde must be used for each round of experiments.
- Given the high condensation of the sperm chromatin, some authors suggest the inclusion of a chromatin decondensation step in the TUNEL protocol to increase the sensitivity of the assay. In such a procedure, before step 5 the samples are resuspended in a decondensation solution (1,4-Dithiothreitol (DTT) 5 mM; heparin 100 U/ml and 0.1% Triton X-100 in **DPBS**) and incubated in the dark at room temperature (25 °C) for 30 minutes. For more information regarding this procedure, see Antonucci et al. (180).
- It is essential to include positive and negative controls in every round of experiments to ensure the consistency of the results and discard loss of TDT activity, degradation of bromo deoxyuridine triphosphate (BrdUTP), and other methodological problems in case of negative results. For the positive sperm control, DNA damage can be induced by digestion with DNase I by incubating a sample from a healthy donor with 100 µl of DNase I (1 mg/ml) for 1 hour at 37 °C. For the negative sperm control, spermatozoa may be incubated in the same solution from step 7, but without TDT. Store fixed aliquots of these controls in which the DNA fragmentation percentage was previously determined, to process them alongside the future batches of samples to be analysed.
- The multiple centrifugation steps may cause random cell loss; to minimize it, polypropylene or siliconized glass tubes are recommended.
- Avoid electrostatic attachment of cells to the surface of the tubes by performing all steps of the procedure (including fixation) in the same tube. The addition of 1% or 2% BSA into rinsing solutions also decreases cell loss.
- Avoid losing cells due to unnecessary centrifugations because of a disturbed pellet, by leaving 50–100 µl of supernatant during aspiration.
- The incubations must be carried out in moist atmosphere to prevent drying artefacts.
- If a direct labelling is used, the fluorochrome-conjugated deoxynucleotide is included in the reaction solution (0.25–0.5 nmoles per 50 µl). In that case, after the incubation step (step 8), stain sperm directly with the PI solution (step 12) and perform the analysis by flow cytometry using the appropriate excitation and emission wavelengths for the fluorochrome used.
- Due to the short activity time of the staining solution (~24 hours at 4 °C), prepare no more than needed shortly before performing the assay.

- The cells should be analysed as quickly as possible. Prolonged delay (>1 hour) will result in overstaining and degradation of the cells.
- Modified TUNEL methods that also incorporate sperm vitality assessment have also been developed (181-183).

### 3.2.3 Sperm chromatin dispersion test

#### 3.2.3.1 Background

The sperm chromatin dispersion (SCD) test is a light microscopy method to evaluate the susceptibility of sperm DNA to acid denaturation. SCD is based on the principle that intact DNA loops expand following denaturation and extraction of nuclear proteins, whereas when DNA is fragmented, dispersion does not develop or is minimal. This method relies on the capacity of the intact sperm chromatin to form dispersion halos, after being exposed to acid and a lysing solution; the halos correspond to relaxed DNA loops attached to the residual nuclear structure, which are released after the removal of nuclear proteins. The DNA breaks, since they are susceptible to denaturation, prevent this dispersion. The method consists of three main steps: (1) embedding of the spermatozoa in an agarose matrix, which provides an inert suspension-like substrate to manipulate the cells; (2) incubation in an acid DNA unwinding solution followed by a lysing; the acid solution acts as a DNA denaturant, which dissolves the DNA double helix only in the presence of DNA damage, and the lysing solution is used to remove nuclear proteins; (3) washing, dehydration in increasing ethanol baths, and staining for visualization under brightfield microscopy (184, 185).

The SCD test is also available as commercial kits, which provide all the reagents of the assay to ensure its easy application and technical operation and to provide repeatable and consistent results in different clinical laboratories.

#### 3.2.3.2 Main method

Adapted from Fernández et al. (185, 186)

##### Reagents

- 1% low-melting-point aqueous agarose
- 0.65% standard agarose
- **DPBS**
- 0.08 N HCl
- Neutralizing and lysing solution (0.4 M Tris, 0.8 M DTT, 1% SDS and 50 mM ethylenediamine tetra-acetic acid (EDTA), pH 7.5)
- A second neutralizing and lysing solution (0.4 M Tris, 2 M NaCl and 1% SDS, pH 7.5)
- Tris-borate-EDTA buffer (0.09 M Tris-borate and 0.002 M EDTA, pH 7.5)



- 70%, 90% and 100% ethanol
- Wright solution with **DPBS** (1 : 1).

#### Procedure

1. Adjust the concentration of raw semen samples to  $5\text{--}10 \times 10^6$  sperm/ml with DPBS. Fresh samples are preferable, but samples directly frozen in liquid nitrogen may be used. The assay must be validated for fresh and frozen sperm.
2. Mix the sperm suspensions with 1% low-melting-point aqueous agarose (to obtain a 0.7% final agarose concentration) at 37 °C.
3. Pipette 50  $\mu\text{l}$  of the mixtures onto glass slides precoated with 0.65% standard agarose dried at 80 °C.
4. Cover the preparations with coverslips (24 mm  $\times$  60 mm), avoiding trapping air bubbles.
5. Place the slide horizontally on a cold surface, e.g. a metal or glass plate precooled at 4 °C.
6. Place the cold plate with the slide in the fridge at 4 °C for 5 minutes, to allow the agarose to solidify.
7. Remove the coverslip by sliding it gently.
8. Immediately immerse the slides horizontally in a tray with fresh acid denaturation solution (0.08 N HCl) for 7 minutes at 22 °C in the dark.
9. Transfer the slides to a tray with neutralizing and lysing solution (0.4 M Tris, 0.8 M DTT, 1% SDS and 50 mM EDTA, pH 7.5) for 10 minutes at room temperature.
10. Incubate the slides in a second neutralizing and lysing solution (0.4 M Tris, 2 M NaCl and 1% SDS, pH 7.5) for 5 minutes at room temperature.
11. Carefully wash the slides in Tris-borate-EDTA buffer (0.09 M Tris-borate and 0.002 M EDTA, pH 7.5) for 2 minutes.
12. Dehydrated the cells using sequential baths of ethanol at 70%, 90% and 100% for 2 minutes each.
13. Leave the slide to dry horizontally, at room temperature, or in an oven at 37 °C.
14. Cover the dried microgel with a layer of fresh dye solution (Wright solution with DPBS (1 : 1)).
15. Keep the slide horizontal for 10–15 minutes, blowing on it from time to time.
16. Decant the dye solution and briefly and smoothly wash the slide in tap water, then air-dry.
17. Once the desired level of colouration is achieved and the slide is perfectly dried, it can be mounted in a permanent mounting medium if desired.

18. Examine the sample by light microscopy using a 100× immersion oil objective. The study of a minimum of 500 spermatozoa per sample is recommended.

#### Results

The halos of the spermatozoa in the samples can be classified according to the criteria of Fernández et al. (25):

- **Large:** Halo width is similar to or larger than the minor diameter of the core
- **Medium:** Halo size is between those with large and with small halo
- **Small:** Halo width is similar to or smaller than one third of the minor diameter of the core
- **Without halo**
  - **Without halo-degraded:** Those that show no halo and present a core irregularly or weakly stained. This category is associated with severe damage affecting both DNA and protein compound.

The results should be represented as a percentage of each category. The percentage of spermatozoa with fragmented DNA is the sum of those with small halo, without halo and without halo-degraded.

#### Clinical interpretation

The SCD test has a range of small studies that looked to examine its clinical use, including (187). As for other DNA tests, every lab should establish its own reference range using appropriate controls, based on positive and negative predictive values, and be clear what the predictive value relates to (e.g. conception, miscarriage or other phenomena).

#### Technical notes

- The use of sperm suspensions with the recommended cell concentrations is essential to avoid overlapping of sperm cells within the agarose matrix and to facilitate rapid scoring.
- If incubation conditions are not carefully controlled, the halos may be lost by the action of the acid and lysing solutions, producing false positives.
- After drying (step 13), the processed slides may be stored in archive boxes at room temperature in the dark for several months or immediately stained.
- Cell nuclei that lack a tail should be recorded but not included in the final result.
- Mix the cell suspension with the liquid agarose when it has stabilized at 37 °C, to avoid cell damage by heat.
- In parallel to the samples, process a control sperm suspension of a known level of DNA fragmentation as an internal control. These control samples can be kept frozen in aliquots.



### 3.2.3.3 Alternative method

#### Reagents

- Agarose preparation: dissolve agarose (after melting at 95–100 °C) and place 100 µl of melted agarose in Eppendorf tubes
- **BWW** or **HTF**
- Freshly prepared acid denaturation solution (0.08N HCl)
- Lysis solution Tris-HCl 0.4 M, NaCl 2 M, EDTA 0.05 M and 1% SDS, pH 7.5
- Distilled H<sub>2</sub>O
- 70% ethanol, 90% ethanol and 100% ethanol
- Wright's buffer solution.

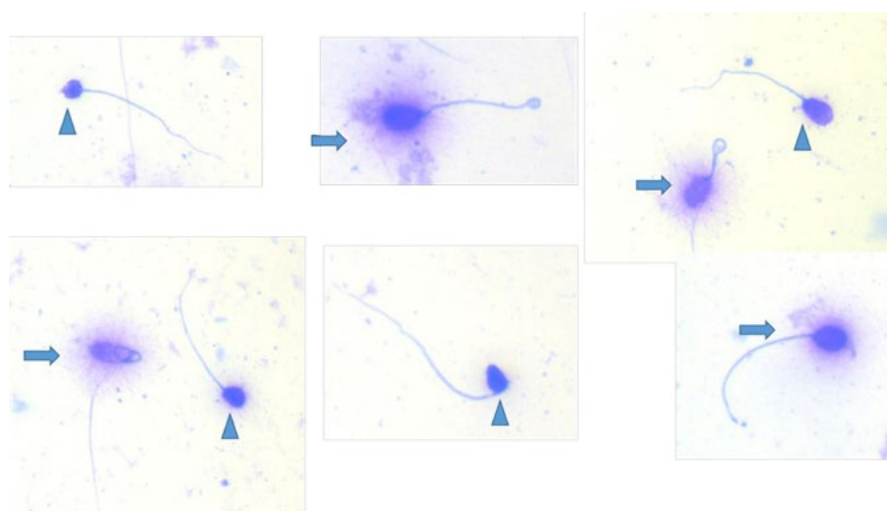
#### Procedure

1. Precoat glass slides with 0.65% standard agarose and let it solidify.
2. Dilute semen samples in an appropriate medium (HTF, BWW) to reach a concentration of 5–20 million spermatozoa/ml.
3. Dispense 60 µl of diluted semen samples (containing a minimum of 300 000 spermatozoa) in the Eppendorf tubes containing melted agarose. Mix well. This step must be performed at 37 °C.
4. Incubate at 37 °C for 5 minutes at room temperature to reduce the temperature of the agarose.
5. Place 8 µl of the mix containing spermatozoa on the precoated slides and cover with a slide cover gently (without pressing). Put each slide at 2–8 °C for 5 minutes.
6. Remove the slide cover carefully, pushing it towards one side and then removing it horizontally and carefully.
7. Immerse the slides horizontally in a tray with freshly prepared acid denaturation solution (0.08N HCl) for 7 minutes at room temperature in the dark.
8. Remove the slides from the denaturation solution and immerse them in 25 ml of the lysing solution (Tris-HCl 0.4 M, NaCl 2 M, EDTA 0.05 M and 1% SDS, pH 7.5) for 25 minutes at room temperature.
9. Wash the slides in distilled water for 5 minutes, renewing the water once or twice.
10. Remove the slides from the water, wipe the back of each one and introduce them into slide barrels containing 70% ethanol (for 2 minutes), then 90% ethanol (for 2 minutes) and finally 100% ethanol (for 2 minutes).
11. Allow all the slides to dry.



12. Stain with Wright's buffer solution by dispensing 10–15 drops of the staining solution directly onto the slides, and wait 15 minutes before rinsing the slides with distilled water.
13. Air-dry the slides and observe them under a light microscope with 40× lens. Distinguish sperm with the halo (intact DNA) from those with small or no halo as in Fig. 3.3. Count at least 500 spermatozoa.

**Fig. 3.3 Sperm with (intact DNA, arrow) and without halo (fragmented DNA, arrowheads)**



Courtesy of Elisabetta Baldi

### 3.2.4 Comet assay

#### 3.2.4.1 Background

The Comet assay is a method to evaluate sDF in individual sperm based on the differential migration of broken DNA strands under the influence of an electric field depending on the charge and size of the strands (188, 189). The name of the test is related to the 'comet' appearance under fluorescence microscope of the stained unwound DNA fragments that are detached from the sperm head after electrophoretic movement.

In this method, the sperm are embedded in a thin agarose matrix, wherein a detergent-induced lysis is promoted under high salt conditions. This treatment removes the nuclear proteins, allowing the generation of nucleoid-like structures, which in alkaline conditions allows the double-stranded DNA within the nucleoids to unwind. During a subsequent electrophoresis step, the broken strands of the DNA migrate towards the anode, generating the characteristic dispersion pattern that resembles a comet tail. The intact DNA constitutes the comet's head, while the fragmented strains of DNA constitute the comet's tail. The relative fluorescence of this last element compared to the head serves as a measure of the level of DNA damage (190).

The principle of the Comet assay is an alkaline denaturation of DNA. The assay exists in many different variants; the procedure presented here has been published by Simon



and Carrell (190). For sperm in this method, the chromatin is then decondensed, e.g. by DTT, and subsequently denatured by alkaline buffer. In the “alkaline” version of the Comet assay with pH 13, the most commonly used in the andrology laboratory (for a review of pH of other protocols using different pHs, see Baumgartner (191), the alkali-labile sites are converted to DNA breaks. During electrophoresis, strands of DNA move in the gel sideways to form a tail of the comet. DNA without breaks remains in the head of the comet. After staining, comet-like objects can be seen in the microscope. Scoring of the comets can be done visually (192) or with the help of different scoring software (193, 194). At least 50 comets per duplicate slide should be scored. Commercial kits and detection software are also available.

### 3.2.4.2 Procedure

### 3.2.4.3 Reagents

- Prepare 25 ml of 0.5% normal-melting-point (NMP) gel (0.250 g NMP agarose (0.5% gel) to 25 ml of **DPBS**) and 0.5% low-melting-point (LMP) agarose in DPBS (0.125 g of LMP agarose (0.5% gel) to 25 ml of DPBS), melt by heating, and place in 45 °C and 37 °C water baths, respectively.
- DPBS
- 250 ml of Triton X-100
- Lysis solution Tris-HCl 0.4 M, NaCl 2 M, EDTA 0.05 M and 1% SDS, pH 7.5
- DTT solution
- Fresh alkaline electrophoresis solution (60 ml of 10 M NaOH + 10 ml of 200 mM EDTA taken up to a volume of 2000 ml with purified water)
- Neutralization buffer (see **Section 8.4.1 on page 226**)
- Stoichiometric DNA dye (e.g. Ethidium Bromide, SYBR Green I or silver staining).



**Note:** ethidium bromide is a mutagenic and carcinogenic intercalating dye. SYBR Green I is a safer intercalating dye.

### 3.2.4.4 Procedure

Adapted from Simon and Carrell (190):

1. Heat the flasks in a microwave to melt the agarose.
2. Place the NMP gel in the 45 °C water bath and the LMP gel in the 37 °C water bath.
3. Carefully pipette 200 µl of NMP gel onto the frosted side of the slide and immediately cover with a coverslip and leave it on the bench at room temperature to allow the agarose to solidify.
4. Adjust the concentration of sperm to  $6 \times 10^6$  sperm/ml using DPBS.
5. Remove the coverslips very gently, to avoid removing or disturbing the layer of agarose.

6. Place 10  $\mu\text{l}$  of the sperm sample (adjusted to  $6 \times 10^6/\text{ml}$  using **DPBS**) into a 0.5 ml Eppendorf tube, and add 75  $\mu\text{l}$  of LMP gel incubated at 37 °C to the sperm.
7. Mix thoroughly and pipette on top of the layer of NMP agarose gel drop by drop.
8. Quickly cover with a coverslip and leave it on the bench at room temperature to allow the agarose to solidify at room temperature for 15 minutes.
9. Remove the lysis solution from the refrigerator, add 250  $\mu\text{l}$  of Triton X-100 and 22.5 ml of lysis stock solution, and mix thoroughly in a Coplin jar.
10. Remove the coverslips from the slides and immerse the slides in lysis solution for 1 hour at 4 °C.
11. Take the slides out of the Coplin jar, add 1.25 ml of DTT, invert to ensure mixing, then return the slides to the Coplin jar, and incubate for 30 minutes at 4 °C.
12. Take the slides out of the Coplin jar, add 1.25 ml of 4 mM lithium diiodosalicyclate (LIS), invert to ensure mixing, then return the slides to the Coplin jar, and incubate for 90 minutes at room temperature.
13. Remove the slides and carefully drain off any remaining liquid by standing them vertically on tissue paper against a support.
14. Fill the horizontal gel electrophoresis tank with fresh alkaline electrophoresis solution (60 ml of 10 M NaOH + 10 ml of 200 mM EDTA taken up to a volume of 2000 ml with purified water).
15. Immerse the slides in the buffer for 20 minutes and start the electrophoresis by applying current at 25 V (0.714 V/cm) adjusted to 300 mA by adding or removing ( $\pm 1$ –20 ml) buffer in the tank using a 20 ml syringe. Perform the electrophoresis for 10 minutes.
16. After electrophoresis, drain the slides on tissue paper as before, place them on a tray, and flood with three changes of neutralization buffer for 5 minutes each.
17. Drain the slides thoroughly to remove the neutralization buffer, and stain with a stoichiometric DNA dye (e.g. add 50  $\mu\text{l}$  of 20 mg/ml EtBr) to each slide and cover with a coverslip.
18. View the slides using a microscope, and analyse 50 comets per slide (Fig 3.4; 3.5).

### 3.2.4.5 Results

Score the first 50 randomly selected comets in each slide using appropriate comet software. However, do not count comets with overlapping tails. Comets with no heads should be considered as sperm containing 100% DNA damage.



### 3.2.4.6 Clinical interpretation

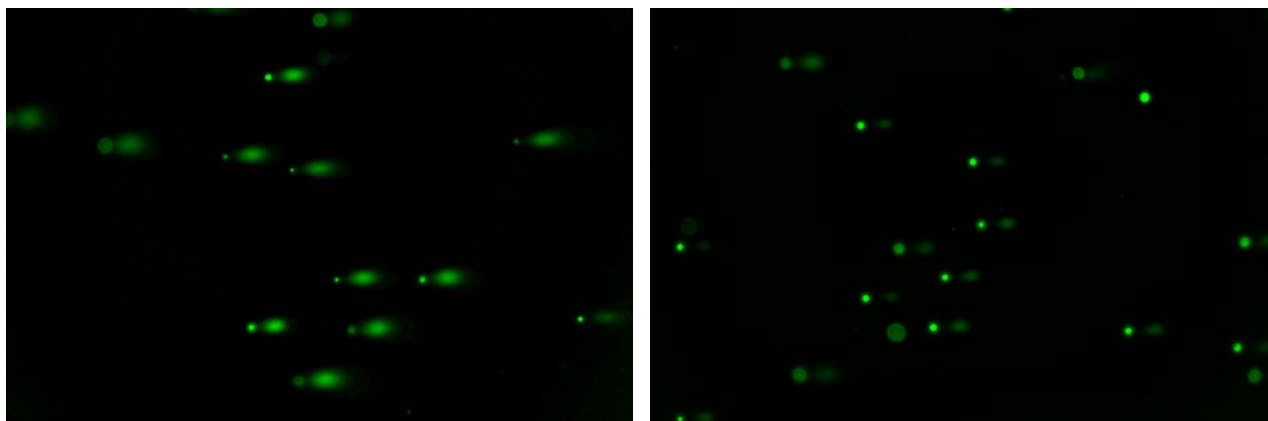
Several studies have reported diagnostic thresholds of sDF when evaluated using the Comet assay. Such limits differ greatly from each other and are dependent on the exact conditions under which the assay is run and the phenotype being investigated (195-198). As for other DNA tests, every laboratory should establish its own reference range using appropriate controls, based on positive and negative predictive values, and be clear what the predictive value relates to (e.g. conception, miscarriage or other phenomena). However, because the Comet assay involves multiple methodological steps, demands a high level of expertise for interpretation of the results and has an important level of inter-laboratory variation, its use may not be appropriate for some laboratories.

### 3.2.4.7 Technical notes

For more details, see Simon and Carrell (190).

- All stock solutions should be prepared with double-distilled water and stored at room temperature, unless otherwise specified.
- To maintain the effectiveness of the lysis buffer, it should not be stored for more than one week. It is recommended to prepare fresh buffer in small volumes based on the needs of the moment.
- The leftovers of agarose can be used up to 5–7 days before the concentration is increased due to evaporation of water from the gel during the melting of the agarose in the microwave.
- If the gel cracks while removing the coverslip, the experiment can be continued without affecting the result of the test. However, cracked gels are more susceptible to sliding off.
- If the agarose gel slides off during the subsequent steps of the protocol, increase the concentration of the NMP agarose from 0.5% to 1%. Do not change the concentration of the LMP gel.
- For adequate lysis of sperm membranes, ensure the proper mixing of Triton X-100 in the lysis buffer by providing gentle movement while avoiding foam formation.
- Ensure the proper mixing of DTT and lithium diiodosalicyclate (LIS) in the lysis buffer to avoid false negatives.
- The sensitivity of the assay will decrease if the electrophoresis buffer is not maintained at pH 13.
- Higher concentrations of EtBr will increase background staining, resulting in decreased visibility of migrated tail DNA.

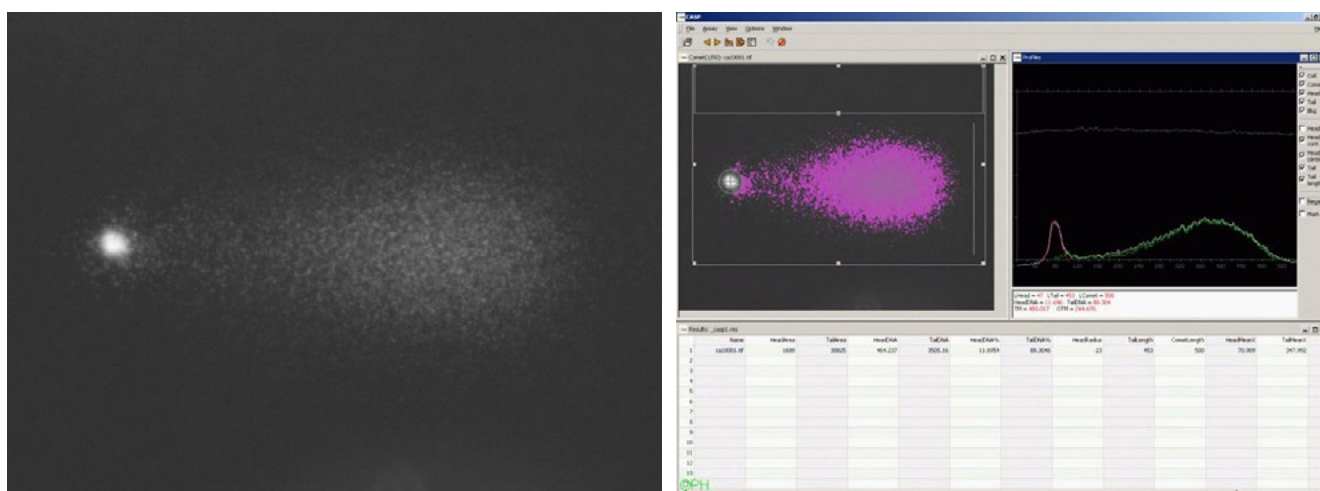
**Fig. 3.4 Comet assay of sperm from an abnormal with extensive DNA fragmentation and normal male lacking visible DNA damage stained with ethidium bromide**



Micrograph by Dolores Lamb and Alexander Bolyakov.

The left panel (abnormal) depicts Comet assay results from a male with extensive DNA fragmentation. The sperm in the abnormal sample show the bright staining with the small green spots (which are the sperm heads), and the “comet tail” is the large, more diffuse staining radiating from the sperm head. When this is compared with a normal male where the DNA is tightly packed in the sperm head, there is no fragmented DNA seen, with just small bright sperm heads stained.

**Fig. 3.5 Comet as seen under a microscope, subsequent scoring with CASP software (tail DNA = 88%)**



Micrograph and analysis by Petr Houska

### 3.2.5 Acridine orange flow cytometry

#### 3.2.5.1 Background

This method is based on the unique property of acridine orange (AO) to emit green fluorescence when it is intercalated between double-stranded DNA, and red fluorescence when it is associated with single-stranded DNA. The current version described by Evenson (199) can be used to assess fresh and/or frozen samples and

comprises only two main methodological steps. In the first step, spermatozoa are treated with a low-pH (1.2) detergent solution to denature their chromatin and allow its subsequent staining. In the second step, the sperm suspension is neutralized, and the cells are stained with a second solution containing AO.

Data for red and green fluorescence are collected by flow cytometry and transformed to determine the degree of red fluorescence in the sperm population, known as the DNA fragmentation index (DFI). The analysis of the collected data can be done in any flow cytometric software. Commercial analysis software is also available.

### 3.2.5.2 Procedures

#### Reagents

- A low-pH (1.2) detergent solution: 0.08 M HCl, 150 mM NaCl, 0.1% Triton X-100, adjusted to pH 1.2 with HCl and/or NaOH
- An AO staining solution containing 6 mg/L purified AO, 0.1 M citric acid, 0.2 M Na<sub>2</sub>HPO<sub>4</sub>, 1 mM disodium EDTA and 150 mM NaCl, adjusted to pH 6.0 with NaOH. Protect the solution from light using aluminium foil or an amber glass.
- TNE (10 Tris Cl, 150 NaCl and 10 EDTA, pH 7.4)
- Prepare an icebox (preferably with a cover to keep samples in the dark), and place the AO staining solution, TNE and the acid detergent solution inside (if evaluating frozen samples, the samples have to be diluted with TNE before freezing).

#### Methodology

Adapted from Evenson, and Evenson and Jost (199-201):

1. Thaw a reference sample and place it in the icebox (for how to prepare a reference sample, refer to Evenson and Jost (201)).
2. Start the flow cytometer and run AO equilibration buffer for 15 minutes, then measure a reference sample (for how to measure samples, see below) and adjust the sensitivity of green and red photomultiplier tubes to 475 and 125, respectively.
3. Dilute samples to  $1-2 \times 10^6$ /ml with TNE and place them in the icebox (if measuring frozen samples, they have to be diluted with TNE before flash freezing in LN<sub>2</sub>).
4. Pipette 200  $\mu$ l of diluted sample into a test tube for flow cytometry, add 400  $\mu$ l of acid detergent (start the stopwatch at the exact time when adding the detergent), swirl gently and place the test tube immediately back in the icebox.
5. After exactly 30 seconds add 1.2 ml of staining solution, mix with the pipette tip and place the test tube immediately back in the icebox.
6. Place the test tube in the flow cytometer and start collecting data at 3 minutes on the stopwatch.
7. Repeat the procedure with a replicate.
8. Let the equilibration buffer flow in the flow cytometer; and start preparing the next sample (up to six samples can be batched as for measuring the reference sample).



9. Use the reference sample to adjust the sensitivity of green and red photomultiplier tubes to 475 and 125, respectively.
10. Analyse 5000 sperm per sample at an event rate of 100–200 cells/second.
11. When all samples have been assessed, rinse the flow cytometer with double-distilled water for 10 minutes to remove most of the AO.
12. Clean the flow cytometer according to the protocol suggested by the manufacturer of the instrument.

### Results

For the analysis of the data, the sperm population is selected by applying a gate in the forward light scatter/side light scatter region. In a subsequent step, a green double-stranded DNA versus red single-stranded DNA fluorescence cytogram is used to gate-in only the AO-positive cells and subtract from the analysis cell debris and apoptotic bodies that lack genetic material. Consecutively, the shift of green to red fluorescence – or DFI – is calculated in each AO-positive sperm using the formula:

$$\text{DNA fragmentation index (DFI)} = (\text{red fluorescence}) / (\text{red fluorescence} + \text{green fluorescence})$$

In a further step, the values of DFI are represented in a histogram, in which, with the use of a reference sample, the values of moderate to high DFI can be found to the right of the main cell population. The percentage of the cells to the right, which represents the total of AO-positive events, is known as %DFI, which is the parameter used for the clinical interpretation of the test. The DFI histogram also provides mean and standard deviation values for DFI.

### Scoring and clinical interpretation

Several studies have reported diagnostic thresholds for DFI measured by acridine orange flow cytometry (202, 203). As for other DNA tests, every laboratory should establish its own reference range using appropriate controls, based on positive and negative predictive values, and be clear what the predictive value relates to (e.g. conception, miscarriage or other phenomena).

### Quality control

- The flow cytometer must be set up according to a reference sperm sample each day, and after repeated analyses of patient samples (6–10 samples) the recalibration with the reference sample must be performed again.
- To ensure that AO is equilibrated with the sample tubing, AO equilibration buffer must be run through the instrument fluidic lines for ~15 minutes prior to sample measurement and between different samples.
- While evaluating the sample, if the event rate is above 250 events/second, a new sample must be prepared, to ensure precise equilibrium between the AO dye and the sperm.



## 3.3 Genetic and genomic tests

Over the past 15 years, it has become increasingly obvious that a significant percentage of male infertility has a genetic or genomic basis. Clinically, there is growing awareness that chromosomal anomalies (numerical, structural, [including microdeletions and microduplications]) and gene mutations underlie a diverse spectrum of male infertility that underlie many of the anomalies seen in a semen analysis. Some andrology laboratories perform genetic and genomic testing, although these tests are more routinely performed in the medical genetics laboratory. The methodology for most genetic and genomic diagnostic tests is not specific for semen-related defects, with the exception of tests of sperm aneuploidy where the methodology for testing the sperm is unique and described below.

### 3.3.1 Sperm aneuploidy test

#### 3.3.1.1 Background

Aneuploidy is the presence of one or a few chromosomes above or below the usual chromosome number. Normally sperm have a haploid complement of chromosomes (22 autosomes and 1 sex chromosome (X, Y)). In an aneuploid sperm there is loss or gains of one or more autosomes and/or sex chromosomes. Unselected infertile men exhibit a 10-fold increased incidence in sperm chromosomal aneuploidy, even with a normal somatic karyotype, due to problems with chromosome segregation during meiosis resulting in the gain (disomy) or loss (nullisomy) of a chromosome. Aneuploid oocytes are well recognized with maternal aging and give rise to aneuploid embryos, resulting in loss. The only aneuploidies consistent with a viable but affected birth result from changes in chromosome number of chromosomes 13, 18, 21, X and Y. Robertsonian translocations are one well-known cause of increased levels of aneuploid sperm. In these men, there can be an accumulation of numerical chromosome anomalies and unbalanced segregation products in the same sperm nucleus (204, 205). Men with balanced reciprocal translocations are also at risk. Fathers of children with Down syndrome constitute a preponderance of balanced reciprocal translocations carriers (204). Increased sperm aneuploidy is also associated with increased levels of DNA fragmentation (206). The other major group of individuals are those male partners in couples with recurrent pregnancy loss (207). Abnormal levels of aneuploid sperm are most commonly observed in men with spermatogenic failure, oligozoospermia or oligoasthenozoospermia, and among normozoospermic men who are partners in couples with recurrent pregnancy loss.

#### 3.3.1.2 Fluorescence in situ hybridization

Fluorescent in situ hybridization is a cytogenetic clinical diagnostic assay that assesses the frequencies of chromosomal abnormalities. Chromosomes X, Y, 13, 18 and 21 are measured in the sperm aneuploidy test because aneuploidies in these chromosomes are associated with a viable but affected offspring (Klinefelter syndrome [XXY-XXXXY], Turner syndrome [X0], Patau [trisomy 13], Edwards [trisomy 18] and Down syndromes [trisomy 21]). Arguably, what may be most informative would be to analyse all chromosomes, because other aneuploidies are embryonic lethals, but this approach is cost-prohibitive. As a screening tool, the result of a sperm aneuploidy test is helpful in the genetic counselling of affected couples (208) (those with recurrent pregnancy loss or previously failed ART in particular and, to a lesser extent, those with astheno-teratozoospermia and severe oligozoospermia)



and in some cases allows couples to make educated reproductive decisions (209). The methodology provided below is adapted from Ryu et al. (210).

#### Reagents

- SSC (diluted from 20× SSC) (3 M NaCl, 0.3 M trisodium citrate 2H<sub>2</sub>O, pH 7.0)
- 2× SSC (diluted from 20× SSC)
- Ethanol washes (100% and diluted to 70% and 80%)
- 25 mM DTT
- Direct-labelled chromosome-specific alpha satellite probes (multicolour DNA probe kit available)
- DAPI II (nuclear counterstain, 4,6-diamidino2-phenylindole).

#### Procedure

According to Ryu et al. (210):

1. Stain and oil are removed by serially placing the slides in xylene for 5 minutes and in ethanol for 5 minutes and then air-drying.
2. The nuclei are then fixed in methanol for 15 minutes. Slides are incubated in 2× SSC and then passed through three ethanol washes (70%, 80% and 100%) for 2 minutes each and allowed to air-dry.
3. Slides are then incubated for 6–8 minutes at 37 °C in a freshly made solution of 25 mM DTT, allowing the sperm heads to decondense and swell. Slides are immediately placed in 2× SSC at room temperature for 3 minutes, then dehydrated in three ethanol washes and allowed to air-dry.
4. Five-colour fluorescence in situ hybridization to detect chromosomes X, Y, 13, 18 and 21 is performed, with direct-labelled chromosome-specific alpha satellite probes that are commercially available (multicolour DNA probes).
5. The probe mixture is sealed onto the slide and then placed in an 80 °C oven for 2–3 minutes to denature cellular DNA and probes simultaneously.
6. After an overnight hybridization at 37 °C, the slide is washed in 0.25× SSC (pH 7.0) at 68 °C for 10 seconds and rinsed in 1× phosphate buffer detergent (multicolour DNA probes).
7. DAPI II solution is applied. Overall hybridization efficiency should be > 97%.

#### Scoring criteria

- The chromosome-specific probes are identified by colour, and the nuclei are analysed for the presence of zero, one, two, or three or more signals for each of three probes.
- Nuclei containing signals that are of unexpected size or that appear to be outside the nuclear membrane are eliminated from analysis.



- Signals are considered to represent a split domain if: (1) the size and intensity of each of the two signals is less than that of the signal for the other homologue; and (2) the distance between the two signals is less than the diameter of either of the two signals. Results are reported as the percentage of sperm with a disomic or more (two chromosomes or more) in an otherwise haploid sperm. Monosomic sperm (missing an entire chromosome) are not counted.

#### Technical note

Automated cytogenetic imaging systems improve precision and accuracy and are a necessity. They include a micro locator and analyses according to a series of rules for cytology in which eight planes of focus are captured and convoluted for the fluorescent microscopy. Software-controlled focus and exposure per field allows multiple focal layers to be captured, signal intensity is maximized, and low levels of background noise are maintained (211).

#### Statistical calculations

The distribution of fluorescence in situ hybridization signals is collectively compared between the infertile and the control groups. Continuous variables are analysed using the two-sample independent *t* test. The Mann-Whitney rank sum test is used for variables with unequal variances. Statistical significance is defined as  $P < 0.05$  for continuous analysis.

#### Basal levels of sperm chromosome disomy

The incidence of sperm aneuploidy is rare in fertile men. The results are similar between different laboratories performing this assay (Table 3.3).

**Table 3.3 Basic levels of sperm chromosome disomy of healthy fertile men**

Chromosome #	Templado et al.	Neusser et al.	Chromosome #	Templado et al.	Neusser et al.
1	0.08	0.16	13	0.12	0.13
2	0.09	0.09	15	0.10	0.10
3	0.20	0.20	16	0.07	0.12
4	0.08	0.10	18	0.06	0.10
6	0.04	0.07	20	0.12	0.12
7	0.06	0.10	21	0.17	0.21
8	0.03	0.18	22	0.47	0.41
9	0.16	0.13	X,Y	0.27	0.21
12	0.14	0.09			

Adapted from Templado et al. and Neusser et al. (212, 213)

## 3.4 Tests related to immunology and immunological methods

### 3.4.1 Assessment of leukocytes in semen

Leukocytes, predominantly polymorphonuclear leukocytes (neutrophils), are present in most human ejaculates (53, 214). They can sometimes be differentiated from spermatids and spermatocytes in a semen smear stained using the Papanicolaou procedure (Section 2.4.9.3 on page 47). Differentiation is based on differences in staining colouration, and on nuclear size and shape (53). Polymorphonuclear leukocytes can easily be confused morphologically with multinucleated spermatids, but stain a bluish colour, in contrast to the more pinkish colour of spermatids (53). Nuclear size may also help identification: monocyte nuclei exhibit a wide variation in size, from approximately 7 µm for lymphocytes to over 15 µm for macrophages. These sizes are only guidelines, since degeneration and division affect the size of the nucleus.

There are several other techniques for quantifying the leukocyte population in semen. As peroxidase-positive granulocytes are the predominant form of leukocytes in semen, routine assay of peroxidase activity is useful as an initial screening technique (53, 215) (See section 3.4.1.1. below).

Leukocytes can be further differentiated with more time-consuming and expensive immunocytochemical assays against common leukocyte and sperm antigens (98, 216) (Section 3.4.2 on page 113).

#### 3.4.1.1 Staining cellular peroxidase using ortho-toluidine

This test is quick and inexpensive and is a useful initial screening for granulocytes.

##### Principle

Traditionally, leukocytes in human semen are counted using a histochemical procedure that identifies the peroxidase enzyme, which is characteristic of granulocytes (Fig. 3.6). This technique has the advantage of being relatively easy to perform, but it does not detect:

- activated polymorphs that have released their granules; or
- other types of leukocyte, such as lymphocytes, macrophages and monocytes, that do not contain peroxidase.

The test can be useful in distinguishing polymorphonuclear leukocytes from multinucleated spermatids, which are peroxidase-free (53). The assay below is based on Nahoum and Cardozo (217). A commercial kit for this test is available.

##### Reagents

- Phosphate buffer, 67 mmol/L, pH 6.0: dissolve 9.47 g of sodium hydrogen phosphate ( $\text{Na}_2\text{HPO}_4$ ) in 1000 ml of purified  $\text{H}_2\text{O}$  and 9.08 g of potassium dihydrogen phosphate ( $\text{KH}_2\text{PO}_4$ ) in 1000 ml of purified  $\text{H}_2\text{O}$ . Add one solution to the other (approximately 12 ml of  $\text{Na}_2\text{HPO}_4$  solution to 88 ml of  $\text{KH}_2\text{PO}_4$  solution) until the pH is 6.0.
- Saturated ammonium chloride ( $\text{NH}_4\text{Cl}$ ) solution: add 250 g of  $\text{NH}_4\text{Cl}$  to 1000 ml of purified  $\text{H}_2\text{O}$



- 148 mmol/L disodium ethylenediamine tetra-acetic acid (Na<sub>2</sub>EDTA): dissolve 50 g/L in phosphate buffer (pH 6.0) prepared in step 1
- Substrate: dissolve 2.5 mg of o-toluidine in 10 ml of 0.9% (9 g/L) saline
- Hydrogen peroxide (H<sub>2</sub>O<sub>2</sub>) 30% (v/v): as purchased
- Working solution: to 9 ml o-toluidine solution, add 1 ml of saturated NH<sub>4</sub>Cl solution, 1 ml of 148 mmol/L Na<sub>2</sub>EDTA and 10 µl of 30% (v/v) H<sub>2</sub>O<sub>2</sub> and mix well. This solution can be used up to 24 hours after preparation.



**Note:** The International Agency for Research on Cancer (IARC, 1982) has stated that ortho-toluidine should be regarded, for practical purposes, as if it presented a carcinogenic risk to humans. Take suitable precautions (Section 8.2 on page 214).

#### Procedure

1. Mix the semen sample well (see Technical note below).
2. Remove a 0.1-ml aliquot of semen and mix with 0.9 ml of working solution (1+9 (1 : 10) dilution).
3. Vortex the sperm suspension gently for 10 seconds and incubate at room temperature for 20–30 minutes. Alternatively, shake continuously with a tube rocking system.
4. Remix the semen sample before removing a replicate aliquot and mixing with working solution as above.

#### Technical note: Thorough mixing of semen

Before removing an aliquot of semen for assessment, mix the sample well in the original container, but not so vigorously that air bubbles are created. This can be achieved by aspirating the sample 10 times into a wide-bore (approximately 1.5 mm diameter) disposable plastic pipette (sterile when necessary). Do not mix with a vortex mixer at high speed, as this will damage spermatozoa.

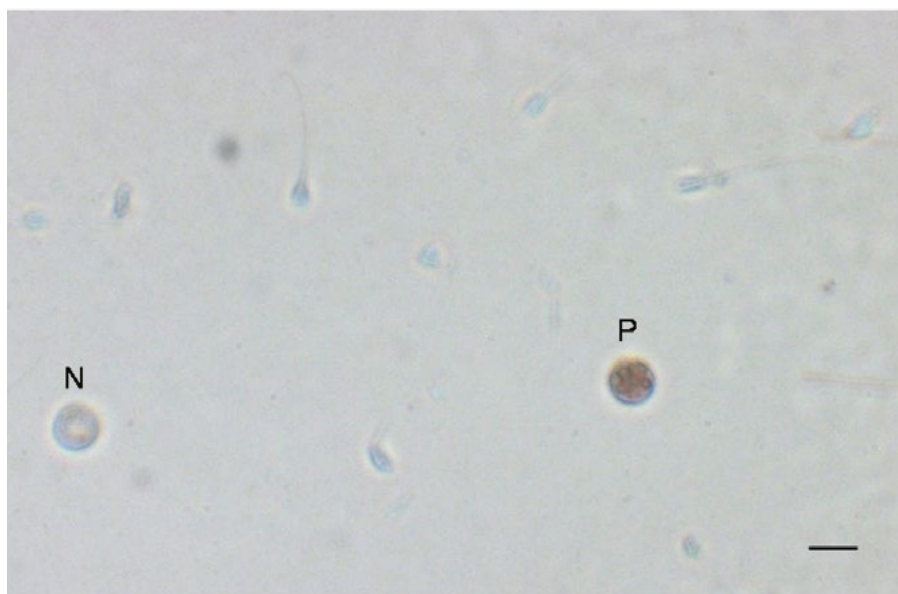
#### Assessing peroxidase-positive cell number in the haemocytometer chambers

1. After 20–30 minutes, mix the sperm suspensions again and fill each side of a haemocytometer with one of the replicate preparations.
2. Store the haemocytometer horizontally for at least 4 minutes at room temperature in a humid chamber (e.g. on water-saturated filter paper in a covered Petri dish) to prevent drying out and to allow the cells to settle.
3. Examine the chamber grid by grid with phase contrast optics at ×200 or ×400 magnification.
4. Count at least 200 peroxidase-positive cells in each replicate, to achieve an acceptably low sampling error (**Table 2.3 on page 33**). Peroxidase-positive cells are stained brown, while peroxidase-negative cells are unstained (Fig. 3.6).
5. Examine one chamber, grid by grid, and continue counting until at least 200 peroxidase-positive cells have been observed and a complete grid has been examined. Counting must be done by complete grids; do not stop in the middle of a grid.



6. Make a note of the number of grids assessed to reach at least 200 peroxidase-positive cells. The same number of grids will be counted from the other chamber of the haemocytometer.
7. Tally the number of peroxidase-positive cells and grids with the aid of a laboratory counter.
8. Switch to the second chamber of the haemocytometer and perform the replicate count on the same number of grids as the first replicate, even if this yields fewer than 200 peroxidase-positive cells.
9. Calculate the sum and difference of the two numbers of peroxidase-positive cells.
10. Determine the acceptability of the difference from **Table 2.3 on page 33**, the maximum difference between two counts that is expected to occur in 95% of samples because of sampling error alone.
11. If the difference is acceptable, calculate the concentration. If the difference is too high, prepare two new dilutions and repeat the replicate count estimate.
12. Report the average concentration of peroxidase-positive cells to two significant figures.
13. Calculate the total number of peroxidase-positive cells per ejaculate (see **Calculation of peroxidase-positive cell concentration on page 111**).

**Fig. 3.6 Peroxidase-positive cells in human semen**



A peroxidase-positive granulocyte (P) (brown colour) and a peroxidase-negative round cell (N). Scale bar 10  $\mu$ m.

Micrograph courtesy of T.G. Cooper.

### Calculation of peroxidase-positive cell concentration

The concentration of peroxidase-positive cells in semen is their number ( $N$ ) divided by the volume of the total number ( $n$ ) of grids examined for the replicates (where the volume of a grid is 100 nl), multiplied by the dilution factor.

For a 1+9 (1 : 10) dilution, the concentration is  $C = (N/n) \times (1/100) \times 10$  cells per nl =  $(N/n) \times (1/10)$  cells per nl. Thus  $(N/n)$  is divided by 10 to obtain the concentration of peroxidase-positive cells per nl (= million cells per ml).

When all nine grids in each chamber of the haemocytometer are assessed, the total number of peroxidase-positive cells can be divided by the total volume of both chambers (1.8  $\mu$ l), and multiplied by the dilution factor (10), to obtain the concentration in cells per  $\mu$ l (thousand cells per ml).



**Note:** This procedure can be used to calculate round cell concentration when the total number of round cells counted (peroxidase-positive and -negative) is used for  $N$  in the calculation.

### Sensitivity of the method

If there are fewer than 200 peroxidase-positive cells in the chamber, the sampling error will exceed 5%. When fewer than 400 peroxidase-positive cells are found in all grids of both chambers, report the sampling error for the number of cells counted (**Table 2.3 on page 33**).

If fewer than 25 peroxidase-positive cells are counted in each chamber, the concentration will be < 277 000 cells/ml. Report the number of peroxidase-positive cells observed with the comment "Too few cells for accurate determination of concentration (< 277 000/ml)". The absence of peroxidase-positive cells from the aliquot examined does not necessarily mean that they are absent from the rest of the sample.

### Worked examples

#### Example 1

With a 1+9 (1 : 10) dilution, replicate 1 is found to contain 60 peroxidase-positive cells in 9 grids, while replicate 2 contains 90 peroxidase-positive cells in 9 grids. The sum of the values (60+90) is 150 in 18 grids, and the difference (90-60) is 30. From **Table 2.3 on page 33** this is seen to exceed the difference expected by chance alone (24), so the results are discarded, and new replicates are made.

#### Example 2

With a 1+9 (1 : 10) dilution, replicate 1 is found to contain 204 peroxidase-positive cells in 5 grids, while replicate 2 contains 198 peroxidase-positive cells in 5 grids. The sum of the values (204+198) is 402 in 10 grids, and the difference (204-198) is 6. From **Table 2.3 on page 33** this is seen to be less than that found by chance alone (39), so the values are accepted.

The concentration of peroxidase-positive cells in the sample is calculated with the help of **Table 2.4 on page 35**; for a 1+9 (1 : 10) dilution,  $C = (N/n)/10$  cells per nl or  $(402/10)/10 = 4.02$  cells/nl, or  $4.0 \times 10^6$  cells per ml (to two significant figures).

#### Example 3

With a 1+9 (1 : 10) dilution, replicate 1 is found to contain 144 peroxidase-positive cells in 9 grids, while replicate 2 contains 162 peroxidase-positive cells in 9 grids. The sum

of the values (144+162) is 306 in 18 grids, and the difference (162–144) is 18. From **Table 2.3 on page 33** this is seen to be less than that found by chance alone (34), so the values are accepted.

When all nine grids are assessed in each chamber, the concentration of the sample, for a 1+9 (1 : 10) dilution, using **Table 2.4 on page 35**,  $C = 1.7 \times 10^6$  cells per ml to two significant figures. As fewer than 400 cells were counted, report the sampling error for 306 cells given in Table 2.3 (approximately 6%).

#### Example 4

With a 1+9 (1 : 10) dilution, no peroxidase-positive cells are found in either replicate. As fewer than 25 peroxidase-positive cells are found in all 9 grids, the concentration is  $< 277\ 000$  per ml; report that "No peroxidase-positive cells were seen in the samples. Too few cells for accurate determination of concentration ( $< 277\ 000/\text{ml}$ )".

### 3.4.1.2 Limits between normal and pathological result

There are currently no evidence-based reference ranges for peroxidase-positive cells in semen from fertile men. Pending additional evidence, this manual retains the consensus value of  $1.0 \times 10^6$  peroxidase-positive cells per ml as a threshold value for clinical significance. Accordingly, values greater than or equal to  $1.0 \times 10^6$  peroxidase-positive cells per ml are considered abnormal. Several important issues are relevant to this test.

- The total number of peroxidase-positive cells in the ejaculate may reflect the severity of an inflammatory condition (215). The number of peroxidase-positive cells is obtained by multiplying the concentration of peroxidase-positive cells by the semen volume.
- Reports of cut-off values for peroxidase-positive cells in fertile men vary from  $0.5 \times 10^6$ – $1.0 \times 10^6$  polymorphonuclear leukocytes/ml or from  $1 \times 10^6$ – $2 \times 10^6$  total leukocytes/ml (215). Previous editions of this manual have taken  $1 \times 10^6$  leukocytes/ml as the threshold for leukocytospermia. Some have found this value too low (215), while others consider it too high (218, 219), depending on the end-point examined (semen quality, IVF results, presence of bacteria, sperm response to reactive oxygen species).
- Excessive numbers of leukocytes in the ejaculate (leukocytospermia, pyospermia) may be associated with infection and poor sperm quality.
- Leukocyte-dependent damage to spermatozoa depends on the total leukocyte number in the ejaculate and the number of leukocytes relative to the number of spermatozoa.
- Leukocytes can impair sperm motility and DNA integrity through an oxidative attack (**Section 4.1 on page 140**). However, whether the level of leukocytic infiltration observed is damaging depends on factors that are impossible to infer from a semen sample, such as the reason for, timing and anatomical location of the infiltration, as well as the nature of the leukocytes involved and whether they are in an activated state (214, 220, 221).

### 3.4.2 Panleukocyte (CD45) immunocytochemical staining

Polymorphonuclear leukocytes that have released their granules, and other species of leukocyte, such as lymphocytes, macrophages or monocytes, that do not contain peroxidase, cannot be detected by the o-toluidine test for cellular peroxidase (**Section 3.4.1.1 on page 108**) but can be detected by immunocytochemical means. Immunocytochemical staining is more expensive and time-consuming than assessing granulocyte peroxidase activity but is useful for distinguishing between leukocytes and germ cells.

#### 3.4.2.1 Principle

All classes of human leukocytes express a specific antigen (CD45), which can be detected with an appropriate monoclonal antibody. By changing the nature of the primary antibody, this general procedure can be adapted to allow detection of different types of leukocyte, such as macrophages, monocytes, neutrophils, B-cells or T-cells, should they be the focus of interest.

#### 3.4.2.2 Reagents

- **DPBS**
- Tris-buffered saline (**TBS** – see **Section 8.4 on page 225**), pH 8.2
- Tetramisole-HCl (levamisole) 1.0 mol/L: dissolve 2.4 g levamisole in 10 ml of purified water
- Substrate: to 9.7 ml of TBS (pH 8.2) add 2 mg of naphthol AS-MX phosphate, 0.2 ml of dimethylformamide and 0.1 ml of 1.0 mol/L levamisole. Just before use, add 10 mg of fast red TR salt and filter (0.45 µm pore size).
- Fixative: acetone alone or acetone/methanol/formaldehyde: to 95 ml of acetone add 95 ml of absolute methanol and 10 ml of 37% (v/v) formaldehyde
- Primary antibody: a mouse monoclonal antibody against the common leukocyte antigen, encoded CD45
- Secondary antibody: anti-mouse rabbit immunoglobulins. The dilution used will depend on the antibody titre and source.
- Alkaline phosphatase–anti-alkaline phosphatase complex (APAAP)
- **Harris's haematoxylin** staining mixture (as counterstain).

#### 3.4.2.3 Procedure

Preparing the ejaculate

1. Mix the semen sample well without creating air bubbles.
2. Mix an aliquot of approximately 0.5 ml with five volumes of DPBS.



3. Centrifuge at 500g for 5 minutes, remove the supernatant and suspend the sperm pellet in five times its volume of **DPBS**.
4. Centrifuge at 500g for 5 minutes.
5. Repeat this procedure once more and resuspend the pellet in DPBS to approximately  $50 \times 10^6$  spermatozoa per ml.

#### Preparing the ejaculate smears

1. Make replicate smears on clean glass slides (**Section 2.4.7.1 on page 26**) from 5- $\mu$ l aliquots of the suspension and allow to air-dry.
2. Fix the air-dried cells in absolute acetone for 10 minutes or in acetone/ethanol/formaldehyde for 90 seconds.
3. Wash twice with TBS and allow to drain.
4. The slides can then be stained immediately or wrapped in aluminium foil and stored at  $-70^\circ\text{C}$  for later analysis.

#### Incubating with antibodies

1. On each slide, mark an area of fixed cells (a circle of about 1 cm diameter) with a grease pencil (delimiting pen) and cover the area with 10  $\mu$ l of primary monoclonal antibody.
2. Store the slide horizontally for 30 minutes at room temperature in a humid chamber (e.g. on water-saturated filter paper in a covered Petri dish) to prevent drying out.
3. Wash the slides twice with **TBS** and allow to drain.
4. Cover the same area of the smear with 10  $\mu$ l of secondary antibody and incubate for 30 minutes in a humid chamber at room temperature.
5. Wash twice with TBS and allow to drain.
6. Add 10  $\mu$ l of APAAP to the same area.
7. Incubate for 1 hour in a humid chamber at room temperature.
8. Wash twice in TBS and allow to drain.
9. Incubate with 10  $\mu$ l of naphthol phosphate substrate for 20 minutes in a humid chamber at room temperature.



**Note:** To intensify the reaction product, staining with the secondary antibody and APAAP can be repeated, with a 15-minute incubation period for each reagent.

#### Counterstaining and mounting

1. Once the slides have developed a reddish colour, wash with TBS.
2. Counterstain for a few seconds with haematoxylin; wash in tap water and mount in an aqueous mounting medium (**Section 2.4.9 on page 41**).

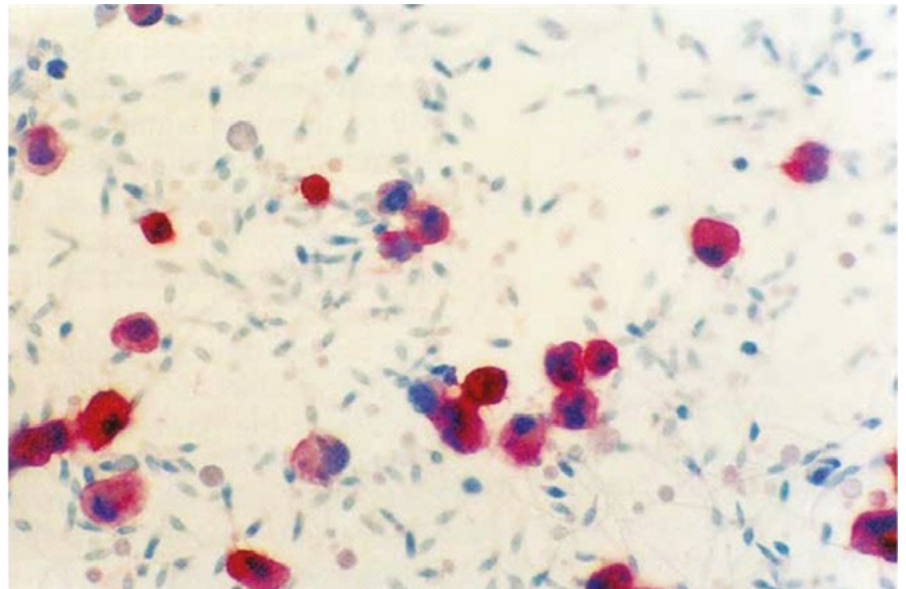




### Assessing CD45-positive cell numbers

1. Examine the entire stained area of the slide with brightfield optics at  $\times 200$  or  $\times 400$  magnification. CD45-positive cells (leukocytes) are stained red (Fig. 3.7).
2. Score CD45-positive cells and spermatozoa separately until at least 200 spermatozoa have been observed in each replicate, to achieve an acceptably low sampling error (**Table 2.3 on page 33**).
3. Tally the number of CD45-positive cells and spermatozoa with the aid of a laboratory counter.
4. Assess the second smear in the same way (until 200 spermatozoa have been counted).
5. Calculate the sum and difference of the two counts of CD45-positive cells.
6. Determine the acceptability of the difference from **Table 2.3 on page 33**, the maximum difference between two counts that is expected to occur in 95% of samples because of sampling error alone.
7. If the difference is acceptable, calculate the concentration (**Table 2.4 on page 35**). If the difference is too high, reassess the slides in replicate.
8. Report the average concentration of CD45-positive cells to two significant figures.
9. Multiply the concentration of CD45-positive cells by the semen volume (ml) to obtain the total number of CD45-positive cells per ejaculate.

**Fig. 3.7 Leukocytes in semen**



CD45-bearing cells (leukocytes) are stained red.

Micrograph courtesy of R.J. Aitken.

### Calculation of concentration

The concentration of CD45-positive cells is calculated relative to that of spermatozoa. If  $N$  is the number of CD45-positive cells counted in the same number of fields as 400 spermatozoa, and  $S$  is the concentration of spermatozoa in millions per ml, then the concentration ( $C$ ) of CD45-positive cells in millions per ml can be calculated from the formula  $C = S \times (N/400)$ .

### Worked examples

#### Example 1

In replicate 1 there are 20 CD45-positive cells per 200 spermatozoa, while in replicate 2 there are 40 CD45-positive cells per 200 spermatozoa. The sum of the values (20+40) is 60, and the difference (40–20) is 20. From **Table 2.3 on page 33** this is seen to exceed the difference expected by chance alone (15), so the results are discarded, and new assessments are made.

#### Example 2

In replicate 1 there are 25 CD45-positive cells per 200 spermatozoa, and in replicate 2 there are 35 CD45-positive cells per 200 spermatozoa. The sum of the values (25+35) is 60, and the difference (35–25) is 10. From **Table 3.4 on page 122** this is seen to be less than that found by chance alone (15), so the values are accepted.

For 60 CD45-positive cells per 400 spermatozoa and a sperm concentration of  $70 \times 10^6$  cells/ml, the CD45-positive cell concentration is  $C = S \times (N/400)$  cells/ml =  $70 \times 10^6 \times (60/400) = 10.5 \times 10^6$  cells/ml, or  $10 \times 10^6$  cells/ml to two significant figures. As fewer than 400 cells were counted, report the sampling error for 60 cells given in **Table 2.3 on page 33** (approximately 13%).

### 3.4.2.4 Limits between normal and pathological results

There are currently no evidence-based reference values for CD45-positive cells in semen from fertile men. The consensus threshold value of  $1.0 \times 10^6$  cells/ml for peroxidase-positive cells implies a higher concentration of total leukocytes, since not all leukocytes are peroxidase-positive granulocytes.

## 3.5 Assessment of interleukins – marker of male genital tract inflammation

### 3.5.1 Background

Chronic inflammatory conditions of the male genital tract (MGT) play an important role in fertility disorders. Ejaculate characteristics of patients affected by MGT infections/inflammations are the presence of leukocytes over 1 million/ml and increased viscosity, whereas the most frequent clinical symptoms reported by the patients is chronic pelvic pain. MGT infections/inflammations may impair fertility by damaging spermatozoa through a direct effect of inflammatory mediators or reactive oxygen species (ROS) produced by inflammatory cells or by altering MGT microenvironment.

Chemokines are a large family of small cytokines constituted by two subfamilies, CXC and CC chemokines, which are distinguished on the basis of the position of the first two cysteines: separated by one amino acid in CXC and adjacent in CC.

Chemokines are produced by several cell types, including monocytes, activated T lymphocytes and neutrophils, and act synergistically or additively on the function of target cells.

Evaluation of chemokines and cytokines in semen may be required by andrologists and urologists to deepen the diagnostic procedure of infertile males affected by MGT inflammatory states. There are several studies reporting alterations of semen cytokines and chemokines in prostatitis and other MGT inflammatory states. Penna et al. quantified seminal plasma levels of eight cytokines and nine chemokines by multiplex cytokine and chemokine arrays in controls and men with symptoms of chronic prostatitis or chronic pelvic pain syndrome. They found that IL-8 levels are the best predictor in the diagnosis of both conditions with high accuracy and sensitivity. Several kits for measurement of interleukins (ILs) in serum, plasma and cell culture supernatant are commercially available and can be easily adapted for semen.

### 3.5.2 Protocol

Principle: A biotinylated anti-human IL antibody is used to measure IL by ELISA assay.

#### 3.5.2.1 Reagents

- Coating buffer: 0.1 M sodium carbonate, pH 9.5
- 8.4 g  $\text{NaHCO}_3$  + 3.56 g  $\text{Na}_2\text{CO}_3$  + 1 L of distilled  $\text{H}_2\text{O}$  (pH 9.5)
- PBS buffer pH 7
- Dilution buffer: **DPBS** with 10% Fetal Bovine Serum, pH 7
- Washing buffer: DPBS with 0.05% TWEEN 20
- Substrate solution: tetramethylbenzidine (TMB) and hydrogen peroxide (Sigma T0440, ready to use)
- Stop solution: 1 M  $\text{H}_3\text{PO}_4$  or 2 N  $\text{H}_2\text{SO}_4$ .

#### 3.5.2.2 Preparation of reagents

- Coating solution: capture antibody, anti-human IL (diluted in coating buffer)
- Solution A/B: 50  $\mu\text{l}$  of detection antibody (biotinylated anti-human IL appropriately diluted in dilution buffer) + 50  $\mu\text{l}$  enzyme reagent (streptavidin-horseradish peroxidase conjugate) + 12.4 ml of dilution buffer. Commercial anti-human ILs can be used.

#### 3.5.2.3 Procedure

- Day 1: Coat the plate by adding anti-IL antibody in the coating buffer in each well, covering the plate and incubating overnight at 4 °C.



- Day 2:
  - Wash the plate three times with 300 µl of washing buffer.
  - Add 200 µl of dilution buffer and leave at room temperature for 1 hour.
  - Reverse the plate and wash again three times with 300 µl of washing buffer.
  - Add IL standard solutions (0.1–1–10–50–100–500 pg/ml) or semen samples (a dilution may be needed in some cases) in the respective wells and incubate for 2 hours at room temperature.
  - Reverse the plate and wash five times with 300 µl of washing buffer.
  - Add 100 µl of aniline blue (AB) solution and incubate 1 hour at room temperature.
  - Reverse the plate and wash seven times with 300 µl of washing buffer, waiting at least 30 seconds each washing time.
  - Add 100 µl of substrate solution and incubate in the dark for 30 minutes at room temperature.
  - Add 50 µl of stop solution.
  - Read the absorbance at 450 nm and 570 nm within 30 minutes. Subtract absorbance at 570 nm from that of 450 nm. Build a standard curve and read the values of absorbance of each semen sample.

### 3.6 Assessment of immature germ cells in the ejaculate

Germ cells include round spermatids and spermatocytes, but rarely spermatogonia. They can be detected in stained semen smears but may be difficult to distinguish from inflammatory cells when the cells are degenerating. The *WHO laboratory manual for the examination of human semen and sperm cervical mucus interaction, fourth edition* stated that > 6 million immature germ cells/ml was abnormal (4). This is no longer provided as a reference, as no firm evidence base could be found for this cut-off value.

Spermatids and spermatocytes can sometimes be differentiated from leukocytes in a semen smear stained using the Papanicolaou procedure (53). Identification can be based on staining colouration, nuclear size and shape, absence of intracellular peroxidase, and lack of leukocyte-specific antigens. Multinucleated spermatids can easily be confused morphologically with polymorphonuclear leukocytes but stain a pinkish colour, in contrast to the more bluish polymorphonuclear leukocytes (53). Round spermatids may be identified using stains specific for the developing acrosome (222), lectins or specific antibodies (216, 223).

Nuclear size may also help in identification: spermatogonia (very rarely seen in semen) have a nucleus of approximately 8 µm, whereas spermatocytes have a nucleus of approximately 10 µm, and spermatids have a nucleus of approximately 5 µm. These sizes are only guidelines, since degeneration and division affect the size of the nucleus.



### 3.7 Testing for antibody coating of spermatozoa

If spermatozoa demonstrate agglutination (i.e. motile spermatozoa stick to each other head to head, tail to tail or in a mixed way), the presence of sperm antibodies is one possible cause to be investigated. Several important comments about antibodies are relevant.

- Sperm antibodies can be present without sperm agglutination; equally, agglutination can be caused by factors others than sperm antibodies.
- The mere presence of sperm antibodies is insufficient for a diagnosis of sperm autoimmunity. It is necessary to demonstrate that the antibodies interfere severely with sperm function; this is traditionally done by a sperm-mucus penetration test. Antibodies can also interfere with zona binding and the acrosome reaction. The presence of anti-sperm antibodies (ASAB) can also impair sperm transit through the cervical mucus (224).

ASAB in semen belong almost exclusively to two immunoglobulin classes: IgA and IgG. IgM antibodies, because of their larger size and main function in the acute phase of infection, are rarely found in semen. IgA antibodies may have greater clinical importance than IgG antibodies (225), but more than 95% of cases with IgA sperm antibodies are also positive for IgG. Both classes can be detected on sperm cells or in biological fluids in related screening tests.

- Tests for antibodies on spermatozoa ("direct tests"): Two direct tests are described here: the mixed antiglobulin reaction (MAR) test (for review, see Bronson et al. (226, 227)) and the immunobead (IB) test (228, 229). The MAR test is performed on a fresh semen sample, while the IB test uses washed spermatozoa. The results from the two tests do not always agree (230-233), but IB test results are well correlated with the results of the immobilization test that detects antibodies in serum. The experimental protocols for the IB and MAR tests vary, but for both the sperm/bead preparation is examined using a microscope. The beads adhere to the motile and immotile spermatozoa that have surface-bound antibodies; the percentage of motile spermatozoa with bound beads is recorded.
- Tests for ASAB in sperm-free fluids, i.e. seminal plasma, blood serum and solubilized cervical mucus ("indirect" tests): In these tests, the diluted, heat-inactivated fluid suspected of containing ASAB is incubated with antibody-free donor spermatozoa that have been washed free of seminal fluid. Any ASAB in the suspect fluid will bind specifically to the donor spermatozoa, which are then assessed in a direct test, as above. For reliable results, it is important to allow sufficient time for the sperm-antibody interaction, since it may take up to 10 minutes for the mixed agglutination to become visible. However, it should be borne in mind that sperm motility declines with time, and the tests depend on the presence of motile spermatozoa.
- Sperm penetration into the cervical mucus and in vivo fertilization tend to be significantly impaired when 50% or more of the motile spermatozoa have antibody bound to them (224, 234). Particle binding restricted to the tail tip is not associated with impaired fertility and can be present in fertile men (235).



**Note 1:** The MAR tests described here are commercially available, whereas the IB test is not; however, the IBs can be made in the laboratory. Both depend on the presence of motile spermatozoa. If there are insufficient motile spermatozoa, indirect tests on seminal plasma or blood serum must be used.





**Note 2:** Cytotoxic antibodies that kill all spermatozoa or impair sperm motility severely cannot be detected with these assays.

### 3.7.1 The mixed antiglobulin reaction test

The MAR test is an inexpensive, quick and sensitive screening test (236), but it provides less information than the direct IB test (**Section 3.7.2 on page 121**).

In the MAR test, a “bridging” antibody (anti-IgG or anti-IgA) is used to bring the antibody-coated beads into contact with unwashed spermatozoa in semen bearing surface IgG or IgA. The direct IgG and IgA MAR tests are performed by mixing fresh, untreated semen separately with latex particles (beads) or treated red blood cells coated with human IgG or IgA. A monospecific anti-human-IgG or anti-human-IgA is added to the suspensions. The formation of mixed agglutinates between particles and motile spermatozoa indicates the presence of IgG or IgA antibodies on the spermatozoa. (Agglutination between beads serves as a positive control for antibody–antigen recognition).

#### 3.7.1.1 Procedure

1. Mix the semen sample well without creating bubbles.
2. Remove replicate aliquots of 3.5 µl of semen and place on separate microscope slides.
3. Include one slide with 3.5 µl of ASAB-positive semen and one with 3.5 µl of ASAB-negative semen as controls in each direct test. This semen should be from men with and without ASAB, respectively, as shown in previous direct MAR tests. Alternatively, positive spermatozoa can be produced by incubation in serum known to contain antibodies.
4. Add 3.5 µl of IgG-coated latex particles (beads) to each droplet of test and control semen, and mix by stirring with the pipette tip.
5. Add 3.5 µl of antiserum against human IgG to each semen–bead mixture and mix by stirring with the pipette tip.
6. Cover the suspension with a coverslip (22 mm × 22 mm) to provide a depth of approximately 20 µm.
7. Store the slide horizontally for 3 minutes at room temperature in a humid chamber (e.g. on water-saturated filter paper in a covered Petri dish) to prevent drying out.
8. Examine the wet preparation with phase contrast optics at ×200 or ×400 magnification after 3 minutes and again after 10 minutes.
9. Repeat the procedure using IgA- instead of IgG-coated beads and anti-IgA instead of anti-IgG antibodies.



### 3.7.1.2 Scoring

If spermatozoa have antibodies on their surface, the latex beads will adhere to them. The motile spermatozoa will initially be seen moving around with a few or even a group of particles attached. Eventually the agglutinates become so massive that the movement of the spermatozoa is severely restricted. Sperm that do not have coating antibodies will be seen swimming freely between the particles.

The goal of the assay is to determine the percentage of motile spermatozoa that have beads attached to them. A common problem occurs with non-progressive spermatozoa that are close to beads but are not attached. Whether the beads are bound can often be verified by lightly tapping the coverslip with a small pipette tip: the movement of beads in concert with active spermatozoa is indicative of positive binding.

1. Score only motile spermatozoa and determine the percentage of motile spermatozoa that have two or more latex particles attached. Ignore tail-tip binding.
2. Evaluate at least 200 motile spermatozoa in each replicate, to achieve an acceptably low sampling error.
3. Calculate the percentage of motile spermatozoa that have particles attached.
4. Record the class (IgG or IgA) and the site of binding of the latex particles to the spermatozoa (head, midpiece, principal piece).



**Note 1:** If 100% of motile spermatozoa are bead-bound at 3 minutes, take this as the test result; do not read again at 10 minutes.



**Note 2:** If less than 100% of motile spermatozoa are bead-bound at 3 minutes, read the slide again at 10 minutes.



**Note 3:** If spermatozoa are immotile at 10 minutes, take the value at 3 minutes as the result.

### 3.7.1.3 Limits between normal and pathological results

There are currently no evidence-based reference values for antibody-bound spermatozoa in the MAR test of semen from fertile men. As with all clinical laboratory diagnostics tests, each laboratory should define its normal reference ranges by testing a sufficiently large number of normal fertile men.

## 3.7.2 The immunobead test

There are currently no commercial IB tests available, meaning that immunobeads must be made in the laboratory using CNBr-activated Sepharose beads to conjugate anti-human IgG or IgA to the beads according to manufacturers' protocols. Validation and verification of the functionality of the test system should also be performed by the laboratory. The production and control of production of immunobeads is not described here.



### 3.7.2.1 The direct immunobead test

This assay is more time-consuming than the MAR test but provides information about antibodies on spermatozoa that have been removed from possible masking components in seminal plasma.

In the direct IB test, beads coated with covalently bound rabbit anti-human immunoglobulins against IgG or IgA are mixed directly with washed spermatozoa. The binding of beads with anti-human IgG or IgA to motile spermatozoa indicates the presence of IgG or IgA antibodies on the surface of the spermatozoa.

#### Reagents

1. **DPBS**–BSA or **Tyrode's** BSA solution (**Section 8.4 on page 225**)
2. Buffer 1: add 0.3 g of Cohn Fraction V BSA to 100 ml of DPBS or Tyrode's medium
3. Buffer 2: add 5 g of Cohn Fraction V BSA to 100 ml of DPBS or Tyrode's medium
4. Filter all solutions through 0.45 µm filters and warm to 25–35 °C before use.

#### Preparing the immunobeads

1. For each immunobead type (IgG, IgA), add 0.2 ml of stock bead suspension to 10 ml of buffer 1 in separate centrifuge tubes.
2. Centrifuge at 500g or 600g for 5–10 minutes.
3. Decant and discard the supernatant from the washed immunobeads.
4. Gently resuspend the beads in 0.2 ml of buffer 2.

#### Preparing the spermatozoa

The amount of ejaculate required for these assays is determined from the sperm concentration and motility, as shown in Table 3.4.

**Table 3.4** How much semen to use for an immunobead test

Sperm concentration (10 <sup>6</sup> /ml)	Proportion of progressively motile spermatozoa (a+b) (%)	Volume of ejaculate required (ml)
> 50	-	0.2
21–50	> 40	0.4
21–50	< 40 > 10	0.8
10–20	> 40	1.0
10–20	< 40 > 10	2.0
< 10 > 5	> 10	> 2.0

1. Mix the ejaculate well.
2. Transfer the required amount of ejaculate to a centrifuge tube and make up to 10 ml with buffer 1.





3. Centrifuge at 500g for 5–10 minutes.
4. Decant and discard the supernatant from the washed spermatozoa.
5. Gently resuspend the sperm pellet in 10 ml of fresh buffer 1.
6. Centrifuge again at 500g for 5–10 minutes.
7. Decant and discard the supernatant.
8. Gently resuspend the sperm pellet in 0.2 ml of buffer 2.



**Note 1:** Aliquots of more than 1.0 ml require three washings.



**Note 2:** Samples with a low proportion of progressively motile spermatozoa (e.g. 10% or less) may not provide clear-cut results. In this case, consider the indirect IB test (**Section 3.7.2.2 on page 124**).

#### Procedure

ASAB-positive spermatozoa and ASAB-negative spermatozoa should be included as controls in each test. Semen should be from men with and without ASAB, respectively, as detected in previous direct IB tests.

1. Place 5  $\mu$ l of the washed sperm suspension being tested on a microscope slide.
2. Prepare separate slides with 5  $\mu$ l of ASAB-positive spermatozoa and 5  $\mu$ l of ASAB-negative spermatozoa.
3. Add 5  $\mu$ l of anti-IgG immunobead suspension beside each sperm droplet.
4. Mix each anti-IgG immunobead and sperm droplet together by stirring with the pipette tip.
5. Place a 22 mm  $\times$  22 mm coverslip over the mixed droplet to provide a depth of approximately 20  $\mu$ m.
6. Store the slides horizontally for 3–10 minutes at room temperature in a humid chamber (e.g. on water-saturated filter paper in a covered Petri dish). Do not wait longer than 10 minutes before assessing the slides, since immunobead binding decreases significantly during incubation (237).
7. Examine the slides with phase contrast optics at  $\times$ 200 or  $\times$ 400 magnification.
8. Score only motile spermatozoa that have one or more beads bound, as described in **Section 3.7.1.2 on page 121**. Ignore tail-tip binding.
9. Repeat the procedure using the anti-IgA immunobead suspension.



**Note:** To ensure that all binding is assessed within 10 minutes, it is best to stagger the preparation of the slides.

### Clinical interpretation and limits between normal and pathological results

There are currently no evidence-based reference limits for antibody-bound spermatozoa in the IB test of semen from fertile men. As with all clinical diagnostic laboratory tests, the laboratory should define and validate its own reference ranges using pregnancy-proven men with normal semen parameters.

According to previous versions of the manual, diagnosis of immunological infertility was made when 50% or more of the motile spermatozoa (progressive and non-progressive) had adherent particles, but the suggested threshold-level finding was made from a small study (238). Caution should be exercised therefore in over-interpretation of a specific result being causative for subfertility. Particle binding restricted to the tail tip is not associated with impaired fertility and can be present in fertile men (235).

#### 3.7.2.2 The indirect immunobead test

The indirect IB test is used to detect ASAB in heat-inactivated, sperm-free fluids (serum, testicular fluid, seminal plasma or bromelain-solubilized cervical mucus). In this assay, sperm-free body fluid is incubated with washed donor sperm to allow ASAB present to bind to the sperm. Antibody-free donor's spermatozoa take up ASAB present in the tested fluid and are then assessed as in the direct IB test.

#### Reagents

See section on **Reagents for the direct IB test on page 122**.

If cervical mucus is to be tested, prepare 10 IU/ml bromelain, a broad-specificity proteolytic enzyme (EC 3.4.22.32).

#### Preparing the immunobeads

See section on **Preparing the immunobeads on page 122**.

#### Preparing the donor spermatozoa

See section on **preparing the spermatozoa on page 122**.

#### Preparing the patient material to be tested

1. If testing cervical mucus, dilute 1+1 (1 : 2) with 10 IU/ml bromelain, stir with a pipette tip and incubate at 37 °C for 10 minutes. When liquefaction is complete, centrifuge at 2000g for 10 minutes. Use the supernatant immediately for testing, or freeze at -70 °C.
2. Inactivate any complement in the solubilized cervical mucus, serum, seminal plasma or testicular fluid by heating at 56 °C for 30–45 minutes.
3. Dilute the heat-inactivated sample 1+4 (1 : 5) with buffer 2 (e.g. 10 µl of the body fluid to be tested with 40 µl of buffer 2).
4. Include known positive and negative samples, e.g. serum from men with and without ASAB, respectively, as detected in the indirect IB test, as controls in each indirect test. Men who have had a vasectomy can be a source of serum if positive (> 50% spermatozoa with bead binding, excluding tail-tip binding).

Incubating the donor spermatozoa with the material to be tested

1. Mix 50  $\mu$ l of washed donor sperm suspension with 50  $\mu$ l of 1+4 (1 : 5) diluted fluid to be tested.
2. Incubate at 37 °C for 1 hour.
3. Centrifuge at 500g for 5–10 minutes.
4. Decant and discard the supernatant.
5. Gently resuspend the sperm pellet in 10 ml of fresh buffer 1.
6. Centrifuge again at 500g for 5–10 minutes.
7. Decant and discard the supernatant.
8. Repeat the washing steps 5, 6 and 7 above.
9. Gently resuspend the sperm pellet in 0.2 ml of buffer 2.

Procedure

1. Perform the IB test, as described **on page 123**, with the incubated donor spermatozoa.
2. Score and interpret the test as described **on pages 123 and 124**.

### 3.8 Biochemical assays for accessory sex gland function

Poor-quality semen may result from abnormal accessory gland secretions. Secretions from accessory glands can be measured to assess gland function, e.g. citric acid, zinc, glutamyl transpeptidase and acid phosphatase for the prostate; fructose and prostaglandins for the seminal vesicles; and free L-carnitine, glycerophosphocholine (GPC) and neutral  $\alpha$ -glucosidase for the epididymis.

An infection in any of the glands can sometimes cause a temporary decrease in the secretion of markers. An infection can also cause irreversible damage to the secretory epithelium, so that even after the acute infection the secretion may remain low (239, 240).

- Secretory capacity of the prostate. The amount of zinc, citric acid (241) or acid phosphatase (242) in semen gives a reliable measure of prostate gland secretion, and there are good correlations between these markers. A spectrophotometric assay for zinc is described in **Section 3.8.1 on page 126**.
- Secretory capacity of the seminal vesicles. Fructose in semen reflects the secretory function of the seminal vesicles. A spectrophotometric method for its estimation is described in **Section 3.8.2 on page 129**.
- Secretory capacity of the epididymis. L-carnitine, GPC and neutral  $\alpha$ -glucosidase are epididymal markers used clinically. Neutral  $\alpha$ -glucosidase has been shown to be more specific and sensitive for epididymal disorders than L-carnitine and GPC (240). There are two isoforms of  $\alpha$ -glucosidase in the ejaculate: the major, neutral form originates solely from the epididymis, and the minor, acidic form mainly from

the prostate. A simple spectrophotometric method for neutral  $\alpha$ -glucosidase is described in **Section 3.8.3 on page 132**.

- The total content of any accessory gland secretion in the ejaculate reflects the overall secretory function of that gland (83). The total content is obtained by multiplying the marker concentration by the semen volume.

### 3.8.1 Measurement of zinc in ejaculate

#### 3.8.1.1 Background

There may be commercial kits available. A detailed and useful method for assessment of trace zinc in various fluids is given here (243). It can be adapted for semen as an earlier commercial assay (244), modified for the use of a 96-well plate reader with sensitivity 4  $\mu\text{mol/L}$  (245). The volumes of semen and reagents can be proportionally adjusted for spectrophotometers using 3-ml or 1-ml cuvettes. The appropriate corrections must be made in calculating the results.

#### 3.8.1.2 Principle

The compound 2-(5-bromo-2-pyridylazo)-5-(N-propyl-N-sulphopropylamino)-phenol (5-Br-PAPS) binds with zinc, producing a change in colour.

$5\text{-Br-PAPS} + \text{Zn}^{2+} \rightarrow 5\text{-Br-PAPS-Zn}$  complex, which absorbs light at a maximum wavelength of 552 nm.

#### 3.8.1.3 Reagents

- Stock solutions
  - Double-distilled  $\text{H}_2\text{O}$  – for each batch below: in total 400 ml required
  - Carbonate bicarbonate buffer, pH 9.8, 200 mmol/L
    - E.g. Sigma-Aldrich C3041: dissolve 13 capsules in 325 ml of purified water
    - Check that pH is 9.8.
    - Store at +4 °C; shelf life at least 3 months.
  - 5-Br-PAPS, 0.7 mmol/L
    - E.g. Sigma-Aldrich 180017 ( $M_w$  537.3): 19 mg in 50 ml of carbonate bicarbonate buffer
    - Store at +4 °C; shelf life at least 3 months.
  - Sodium citrate, 850 mmol/L
    - E.g. Sigma-Aldrich C3674 ( $M_w$  258.1): 11.0 g in 50 ml of carbonate bicarbonate buffer
    - Store at +4 °C; shelf life at least 3 months.
  - Deferoxamine mesylate, 205 mmol/L
    - E.g. Sigma-Aldrich D9533 ( $M_w$  656.8): 96 mg in 60 ml of carbonate bicarbonate buffer
    - Store at +4 °C; shelf life at least 3 months.

- Salicylaldoxime, 29 mmol/L
  - E.g. Sigma-Aldrich 84172 ( $M_w$  137.1): 239 mg in 60 ml of purified water
  - Store at +4 °C; shelf life at least 3 months.
- Zinc standard (50  $\mu\text{mol/L}$ )
  - Preparation:
    - Dissolve 0.288 g of  $\text{ZnSO}_4 \cdot 7\text{H}_2\text{O}$  in 100 ml of purified water (zinc concentration 10 mmol/L).
    - Dilute this 200 $\times$  (add 0.5 ml to 99.5 ml of purified water) to obtain 50  $\mu\text{mol/L}$  of stock.
    - Mix well and store frozen at -20 °C for up to 1 year in 2-ml aliquots in air-tight tubes.
  - Standard curve: dilute the 50  $\mu\text{mol/L}$  zinc standard with purified water to yield four additional standards of 40, 20, 10 and 5  $\mu\text{mol/L}$ :

Table 3.5 Recommended standards for zinc assessments

Standard	Corresponding <sup>8</sup> to seminal zinc (mM)	Zinc standard 50 $\mu\text{mol/L}$ (ml)	Purified water
40 $\mu\text{mol/L}$	8	0.8	0.2
20 $\mu\text{mol/L}$	4	0.4	0.6
10 $\mu\text{mol/L}$	2	0.2	0.8
5 $\mu\text{mol/L}$	1	0.1	0.9
0 $\mu\text{mol/L}$	0	0	1.0

- Working solutions (prepared on the day for the assay)
  - Solution A: prepare by mixing:
    - Carbonate bicarbonate buffer, 7.0 ml
    - 5-Br-PAPS stock solution, 4.0 ml
    - Sodium citrate stock solution, 4.0 ml
    - Deferoxamin mesylate stock solution, 5.0 ml
  - Final working solution: prepare by mixing:
    - Solution A, 20 ml
    - Salicylaldoxime, 5 ml
    - Shelf life of 1 week at +4–8 °C
- Frozen internal quality control pools of seminal plasma: see **Section 3.8.4 on page 135**.

<sup>8</sup> Dilution factor  $\times 200$  as described in Section 3.9.1. In a material of approximately 45 000 ejaculates, more than 99.5% had less than 8 mM in zinc concentration (246. Björndahl L. Prevalence of high zinc concentrations in 45,000 ejaculates - Unpublished data. 2021).

### 3.8.1.4 Procedure

Steps 1–3 can preferably be done in common with assessment of fructose (**Section 3.8.2 on page 129**) and  $\alpha$ -glucosidase (**Section 3.8.3 on page 132**); also dilution 1 in step 4 can preferably be done in common with fructose assessment.

1. Centrifuge the semen sample remaining after semen analysis for 10–15 minutes at 3000g, decant and store the sperm-free seminal plasma at  $-20^{\circ}\text{C}$  until analysis.
2. Thaw the sperm-free seminal plasma. Also thaw an aliquot of pooled seminal plasma for internal quality control (**Section 3.8.4 on page 135**).
3. Mix the seminal plasma samples well on a vortex mixer.
4. Dilution procedure. The dilution of undiluted semen requires the use of a positive displacement pipette to obtain a correct semen volume. In total, a dilution of 1 : 200 is suitable. The two-step procedure described here simplifies the entire biochemical analysis, since the dilutions used in the first step can also be used for fructose determination.
  - Dilution 1: a 1 : 40 (1+39) dilution of each sample of seminal plasma: to 975  $\mu\text{l}$  of purified  $\text{H}_2\text{O}$  in each of two 1.5-ml tubes, add 25  $\mu\text{l}$  of seminal plasma (with a positive displacement pipette) and mix by vortexing for 5 seconds. The dilutions prepared can also be used for fructose assessments (**Section 3.8.2 on page 129**) without further dilution.
  - Dilution 2: dilute the first dilution 1 : 5 (1+4): to 400  $\mu\text{l}$  purified  $\text{H}_2\text{O}$ , add 100  $\mu\text{l}$  of the 1 : 40 diluted semen from step 1 above (final dilution 1 : 200). Positive displacement pipette not necessary in this step.
5. Add replicate 40- $\mu\text{l}$  aliquots of the diluted semen samples from step 2 to a 96-well plate. Include replicate blanks (40  $\mu\text{l}$  of purified water) and 40- $\mu\text{l}$  replicates of each of the standards.
6. Add 200  $\mu\text{l}$  of colour reagent to each well and mix for 5 minutes on a 96-well plate shaker.
7. Read the plate at 552 nm wavelength (243).

### 3.8.1.5 Calculation

1. Subtract background absorbance values (standard 0  $\mu\text{mol/L}$ ) from standards, tested seminal plasmas and controls.
2. Read the concentration of zinc in the sample from the standard curve ( $\mu\text{mol/L}$ ) by comparing the absorbance values.
3. Results that are above the top standard are extremely unusual (246) and do not indicate a possible clinical disorder – the values may not be exact and can be reported as  $> 8 \text{ mmol/L}$ , and re-assay is usually not necessary.
4. Multiply the results by the dilution factor of 200 to obtain the concentration of zinc ( $\text{mmol/L}$ ) in undiluted seminal plasma.



5. For each semen sample, the average of the two replicates is calculated:

- For results  $> 1.5$  mmol/L, replicates should agree within 10%, i.e. (difference between estimates/mean of estimates)  $\leq 10\%$ . If they do not, repeat the assay on two new aliquots of semen.
- For results  $\leq 1.5$  mmol/L, any difference of more than 0.1 mmol/L should be evaluated to determine if an error in either of the replicates indicates a possibility of diagnostic error or if the difference is clinically irrelevant. If relevant, repeat the assay on two new aliquots of semen.

6. Multiply the concentration by the semen volume (ml) to obtain the total zinc content ( $\mu\text{mol}$ ) of the ejaculate.

### 3.8.1.6 Lower reference limit

A lower reference limit for zinc is  $2.4 \mu\text{mol}$  per ejaculate (245) (and unpublished data from TG Cooper).

## 3.8.2 Measurement of fructose in ejaculate

### 3.8.2.1 Background

The method described below is based on that of Karvonen and Malm (247), modified for use with a 96-well plate reader with sensitivity  $74 \mu\text{mol/L}$  (240). The volumes of semen and reagents can be proportionally adjusted for spectrophotometers using 3-ml or 1-ml cuvettes. The appropriate corrections must be made in calculating the results. Low fructose in semen is characteristic of ejaculatory duct obstruction, bilateral congenital absence of the vas deferens (130, 131, 133), partial retrograde ejaculation or androgen deficiency.

### 3.8.2.2 Principle

Under the influence of heat and low pH, fructose forms a coloured complex with indole, which absorbs light of wavelength 470 nm.

### 3.8.2.3 Reagents

A kit for the estimation of fructose in semen is commercially available. Alternatively, prepare the following reagents.

- Deproteinizing agent 1 ( $63 \mu\text{mol/L ZnSO}_4$ ): dissolve 1.8 g of  $\text{ZnSO}_4 \cdot 7\text{H}_2\text{O}$  in 100 ml of purified water
- Deproteinizing agent 2 (1 mol/L NaOH): dissolve 0.4 g of NaOH in 100 ml of purified water
- Colour reagent (indole  $2 \mu\text{mol/L}$  in benzoate preservative  $16 \mu\text{mol/L}$ ):
  - Dissolve 200 mg of benzoic acid in 90 ml of purified water by shaking it in a water bath at  $60^\circ\text{C}$ .



- Dissolve 25 mg of indole in this and make up to 100 ml with purified water.
- If signs of particulate matters in the solution, filter (0.45 µm pore size).
- Store at +4 °C.
- Fructose standard stock solution (22.4 mmol/L):
  - Dissolve 403 mg of D-fructose in 100 ml of purified water.
  - Store at 4 °C or freeze (-20 °C) in aliquots.
- Standard curve: dilute the 2.24 mmol/L standard with purified water to yield four additional standards of 1.12, 0.56, 0.28 and 0.14 mmol/L:

Table 3.6 Recommended standards for fructose assessments

Standard (mmol/L)	Corresponding <sup>9</sup> to seminal fructose (mmol/L)	Fructose standard 22.4 mmol/L (µl)	Purified water (µl)
2.24	89.6	100	900
1.12	44.8	50	950
0.56	22.4	25	975
0.28	11.2	12.5	988
0.14	5.6	6.3	994
0.0	0.0	0	1000

- Frozen internal quality control pools of seminal plasma: see **Section 3.8.4 on page 135**.

#### 3.8.2.4 Procedure

For steps 1–3, the procedure can be done in common with zinc (**Section 3.8.1 on page 126**) and α-glucosidase (**Section 3.8.3 on page 132**) assessments, and preferably step 4 is done in common with zinc assessments.

1. Centrifuge the semen sample remaining after semen analysis for 10–15 minutes at 3000g, decant and store the sperm-free seminal plasma at -20 °C until analysis.
2. Thaw the sperm-free seminal plasma. Also thaw an aliquot of pooled seminal plasma for internal quality control (**Section 3.8.4 on page 135**).
3. Mix the seminal plasma samples well on a vortex mixer.
4. Dilution: the recommended dilution is 1 : 40. If combined with zinc assessments, further dilutions for zinc measurements can be done from the initial dilution of 1 : 40 necessary for the fructose assay:

<sup>9</sup> Dilution factor ×40 as described in Section 3.8.2.4



- A 1 : 40 (1+39) dilution of each sample of seminal plasma: to 975  $\mu\text{l}$  of purified  $\text{H}_2\text{O}$  in each of two 1.5-ml tubes, add 25  $\mu\text{l}$  of seminal plasma (with a positive displacement pipette) and mix by vortexing for 5 seconds.
- 5. Deproteinize: to 200  $\mu\text{l}$  of 1 : 40 diluted sample, add 50  $\mu\text{l}$  of 63  $\mu\text{mol/L}$   $\text{ZnSO}_4$  and 50  $\mu\text{l}$  of 0.1 mol/L NaOH and mix. Allow to stand for 15 minutes at room temperature, then centrifuge at approximately 8000g for 5 minutes.
- 6. Transfer 100  $\mu\text{l}$  of supernatant from each sample to a test tube. Include 100- $\mu\text{l}$  aliquots of each standard (including blanks).
- 7. Add 100  $\mu\text{l}$  of indole reagent to each tube and mix.
- 8. Add 1 ml of concentrated (37% v/v) hydrochloric acid (HCl) to each sample, cover with self-sealing, mouldable laboratory film and mix carefully in a fume cupboard.
- 9. Heat for 20 minutes at 50  $^\circ\text{C}$  in a water bath. Mix and cool in ice water for 15 minutes.
- 10. Carefully transfer 250  $\mu\text{l}$  in replicate to a 96-well plate in a fume cupboard.
- 11. Seal the 96-well plate with adhesive laboratory film to protect the spectrophotometer from the acid.
- 12. Read the plate at 470 nm wavelength, using the water blank to set the zero.

### 3.8.2.5 Calculation

1. Subtract background absorbance values (standard 0  $\mu\text{mol/L}$ ) from standards, tested seminal plasmas and controls.
2. Read the concentration of fructose in the sample from the standard curve (mmol/L) by comparing the absorbance values.
3. Results that are above the top standard do not indicate a possible clinical disorder – the values may not be exact and can be reported as > 90 mmol/L, and re-assay is usually not necessary.
4. Multiply the results for each sample by the dilution factor of 40 to obtain the concentration of fructose (mmol/L) in undiluted seminal plasma.
5. For each seminal plasma the average of the two replicates is calculated:
  - For results > 10 mmol/L, replicates should agree within 10%, i.e. difference between estimates/mean of estimates  $\leq$  10%.
  - If they do not, repeat the assay on two new aliquots of semen.
  - For results  $\leq$  10 mmol/L, any difference of more than 0.5 mmol/L should be evaluated to determine if an error in either of the replicates indicates a possibility of diagnostic error or if the difference is clinically irrelevant. If relevant, repeat the assay on two new aliquots of semen.

6. Multiply the concentration by the semen volume (ml) to obtain the total fructose content ( $\mu\text{mol}$ ) of the ejaculate.

### 3.8.2.6 Lower reference limit

The lower reference limit for fructose is 13  $\mu\text{mol}$  per ejaculate (245) (and unpublished data from TG Cooper).

## 3.8.3 Measurement of neutral $\alpha$ -glucosidase in ejaculate

### 3.8.3.1 Background

Seminal plasma contains both a neutral  $\alpha$ -glucosidase isoenzyme, which originates in the epididymis, and an acid isoenzyme contributed by the prostate. The latter can be selectively inhibited by sodium dodecyl sulfate (SDS) (248) to permit measurement of the neutral  $\alpha$ -glucosidase, which reflects epididymal function. Accounting for non-glucosidase-related substrate breakdown, by using the inhibitor castanospermine, makes the assay more sensitive. The method described below is for use with a 96-well plate reader with sensitivity 1.9 mU/ml (249). The volumes of semen and reagents can be proportionally adjusted for spectrophotometers with 3-ml or 1-ml cuvettes. The appropriate corrections must be made in calculating the results.

### 3.8.3.2 Principle

Glucosidase converts the synthetic glucopyranoside substrate to p-nitrophenol, which turns yellow (wavelength 405 nm) on addition of sodium carbonate.

### 3.8.3.3 Reagents

A kit for the estimation of epididymal neutral  $\alpha$ -glucosidase in semen is commercially available. Only kits including SDS and castanospermine are recommended for measurement of this enzyme in semen. Alternatively, prepare the following reagents.

- Buffer 1 (0.2 mol/L phosphate, pH 6.8):
  - Dissolve 4.56 g of  $\text{K}_2\text{HPO}_4 \cdot 3\text{H}_2\text{O}$  in 100 ml of purified water.
  - Dissolve 2.72 g of  $\text{K}_2\text{HPO}_4$  in a separate 100 ml of purified water.
  - Mix approximately equal volumes of each until the pH is 6.8.
- Buffer 2: dissolve 1 g of SDS in 100 ml of buffer 1. SDS will precipitate on storage at +4 °C but redissolves on gentle warming.
- Colour reagent 1 (for stopping the reaction, 0.1 mol/L sodium carbonate): dissolve 6.20 g of  $\text{Na}_2\text{CO}_3 \cdot \text{H}_2\text{O}$  in 500 ml of  $\text{H}_2\text{O}$ .

- Colour reagent 2: dissolve 0.1 g of SDS in 100 ml of colour reagent 1.
- Substrate *p*-nitrophenol glucopyranoside (PNPG) (5 mg/ml): dissolve 0.1 g of PNPG in 20 ml of buffer 2 and warm the solution on a hotplate at about 50 °C, stirring for about 10 minutes. A few crystals may remain undissolved. The solution should be kept at 37 °C during use. Make a fresh solution for each assay.
- Glucosidase inhibitor for semen blanks (castanospermine, 10 mmol/L):
  - Dissolve 18.9 mg of castanospermine in 10 ml of purified water.
  - Dilute this 10-fold in purified water to give a 1 mmol/L working solution.
  - Freeze approximately 1-ml aliquots at -20 °C.
- Standard curve
  - Stock solution of product *p*-nitrophenol (stock-PNP) (5 mmol/L):
    - Dissolve 69.5 mg of PNP in 100 ml of purified water, warming the solution if necessary.
    - Store at +4 °C in the dark in an aluminium foil-covered or brown glass bottle.
    - Make up a fresh standard solution every 3 months.
  - Prepare working solution (200 µmol/L working standard) for the standard curve (within the last hour of incubation): place 400 µl of 5 mmol/L stock-PNP in a 10-ml volumetric flask and make up to 10 ml with colour reagent 2.
  - Dilute the 200 µmol/L working standard with colour reagent 2 to yield four additional standards of 160, 120, 80 and 40 µmol/L PNP:

Table 3.7 Recommended standards for assessment of  $\alpha$ -glucosidase activity

Final PNP concentration	Corresponding to semen activity (mIU/ml)	Working solution 200 µmol/L (µl)	Colour reagent 2 (µl)
200 µmol/L PNP	124	1000	0
160 µmol/L PNP	99	800	200
120 µmol/L PNP	74	600	400
80 µmol/L PNP	50	400	600
40 µmol/L PNP	25	200	800
0 µmol/L PNP	0	0	1000

- Frozen internal quality control pools of seminal plasma: see **Section 3.8.4 on page 135**.



### 3.8.3.4 Procedure

Steps 1–3 can be done in common with zinc (**Section 3.8.1 on page 126**) and fructose (**Section 3.8.2 on page 129**) assessments.

1. Centrifuge the semen sample remaining after analysis for 10–15 minutes at 3000g. Decant and store the sperm-free seminal plasma at  $-20\text{ }^{\circ}\text{C}$  until analysis. Sperm-free seminal plasma can be pooled with other samples to provide a quality control pool as an internal standard for future assays.
2. Thaw the sperm-free seminal plasma and mix well on a vortex mixer. Also thaw an aliquot of pooled seminal plasma for internal quality control.
3. Mix the seminal plasma samples well on a vortex mixer.
4. Place aliquots of 15  $\mu\text{l}$  of seminal plasma in each of two 1.5-ml tubes using a positive displacement pipette. Include replicate blanks (15  $\mu\text{l}$  of water) and quadruplicate 15- $\mu\text{l}$  internal quality control samples from semen pools.
5. To two of the internal quality control samples add 8  $\mu\text{l}$  of 1 mmol/L castanospermine to provide the seminal plasma blank value.
6. Add 100  $\mu\text{l}$  of PNPG substrate solution, at about  $37\text{ }^{\circ}\text{C}$ , to each tube.
7. Vortex each tube and incubate at  $37\text{ }^{\circ}\text{C}$  for 2 hours (exact temperature and time control are crucial).
8. Stop incubation after 2 hours by adding 1 ml of colour reagent 1, and mix.
9. Transfer 250  $\mu\text{l}$  of samples and standards to the 96-well plate.
10. Read the plate in a 96-well plate reader at 405 nm wavelength within 60 minutes, using the water blank to set the zero.

### 3.8.3.5 Calculation

1. Read the concentration of PNP produced by the sample from the standard curve ( $\mu\text{mol/L}$ ) by comparing absorbance values.
2. Results that are above the top standard do not indicate a possible clinical disorder – the values may not be exact and can be reported as  $> 124\text{ mIU/ml}$ , and re-assay is usually not necessary.
3. Multiply by the correction factor (0.6194) to obtain the activity of neutral glucosidase in undiluted seminal plasma (IU/L).
4. Subtract the activity (IU/L) of the castanospermine seminal plasma blank from each sample to obtain the corrected (glucosidase-related) activity.
5. Replicates should agree within 10% (i.e. difference between estimates/mean of estimates  $\leq 10\%$ ). If they do not agree, repeat the assay if the two differing results indicate different diagnostic outcomes.



6. Multiply the corrected activity by the semen volume (ml) to obtain the glucosidase activity (mU) of the ejaculate.



**Note:** One international unit (IU) of glucosidase activity is defined as the production of 1  $\mu\text{mol}$  product (PNP) per minute at 37 °C. In this assay the activity is derived from 15  $\mu\text{l}$  seminal plasma in a total volume of 1.115 ml over 120 minutes, so the correction factor is  $(1115/15)/120 = 0.6194$ .

### 3.8.3.6 Reference limits

A lower reference limit for neutral  $\alpha$ -glucosidase is 20 mU/ejaculate (245) (and unpublished data from TG Cooper). In a comparison of 1 262 sperm-free post-vasectomy ejaculates and 1 106 ejaculates with > 40 million spermatozoa, the best cut-off was 23.1 mU/ejaculate (250). There are also indications that post-vasectomy ejaculates collected after a long time of ejaculatory abstinence can have high values for neutral  $\alpha$ -glucosidase, especially in ejaculates with a high content of zinc, indicating a possible interaction by prostate  $\alpha$ -glucosidase with the assay (250).

### 3.8.4 Pools of seminal plasma for internal quality control

A necessary component of semen biochemistry assessments is the systematic use of IQC samples to be run in every analytic batch. Sperm-free seminal plasma obtained after centrifugation (3000g for 10–15 minutes) should be stored at  $-20$  °C until assessment. Leftover seminal plasma after analysis can be refrozen and once or twice annually used to make a large pool of mixed seminal plasma that, after thorough mixing (magnetic stirrer, room temperature), is aliquoted in sufficient volumes for biochemistry analysis batch size. QC samples can be stored at  $-20$  °C in air-tight test tubes for up to 12 months.

A new lot of seminal plasma pool is run in parallel with ongoing QC samples in several replicates in at least three different assays for each analyte. Thereby intra- and inter-assay variability is assessed, and total acceptable variability of the new seminal plasma QC lot determined.

## 3.9 Assessment of sequence of ejaculation

The normal sequence of ejaculation is of physiological importance for sperm function and normal capacity for fertilization and embryonic development. The normal sequence means that the vast majority of spermatozoa are expelled in the first ejaculate fractions, together with mainly prostatic secretion, while the later two thirds of the ejaculate is dominated by seminal vesicular fluid (251, 252). It is well established that sperm motility, survival and chromatin stability are promoted in primary contact with the zinc-rich prostatic secretion, while the opposite is the case for spermatozoa with primary contact with the alkaline, zinc-binding seminal vesicular fluid (13, 253-257).

Inflammatory processes in the prostate or congenital malformations can cause stenosis (or ejaculatory duct obstruction – EDO) at or close to the openings of the ejaculatory ducts into the urethra (258-265). The effect of a stenosis would be a delay of sperm entrance to the urethra until the pressure of the seminal vesicular contraction forces the contents of the ejaculatory duct into the urethra. The laboratory finding at routine semen examination would primarily be poor motility.



Not even biochemical assessment of the entire ejaculate could reveal whether spermatozoa have an abnormal exposure to seminal vesicular fluid. The only way to diagnose EDO by semen examination is by collecting the individual ejaculate fractions and examining sperm content, motility and biochemical composition (prostate and seminal vesicular secretions, respectively) (13).

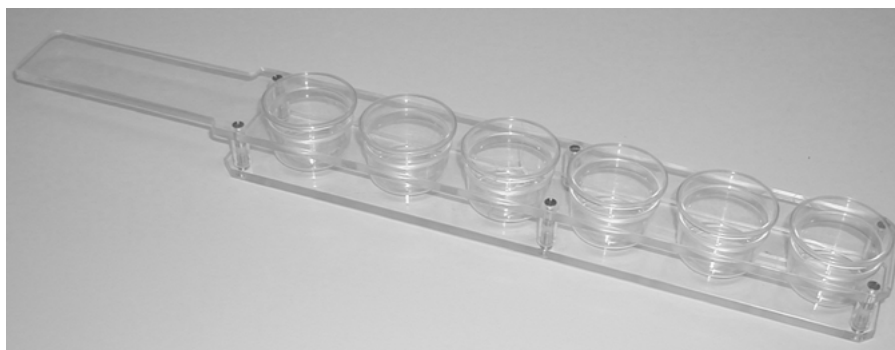
If a disturbed sequence of ejaculation is diagnosed, there are minimally invasive surgical techniques to treat EDO (266-272), and it may also be possible to reduce the negative influence of seminal vesicular fluid by letting the man collect the entire ejaculate directly into a sperm wash medium.

### 3.9.1 Equipment – in addition to routine ejaculate examination

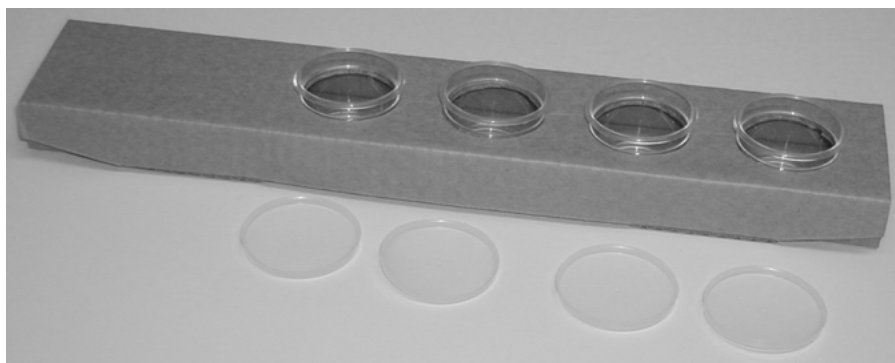
This includes any set of ejaculate collection devices allowing the patient to collect the ejaculate fractions in the order in which they are expelled.

**Fig. 3.8 Two examples of split-ejaculate collection devices**

**A**



**B**



Reproduced with permission from *A Practical Guide to Practical Laboratory Andrology*, Cambridge University Press (273)

### 3.9.2 Patient procedures

The patient is instructed to collect the ejaculate fractions in the order in which they are expelled, with the order confirmed with the patient when vials are presented to the laboratory. Vials should be numbered in sequential order, in addition to the routine identification labelling of the vials.

### 3.9.3 Sample procedures

Coagulum or gel formation is only likely to occur in fractions dominated by seminal vesicular secretion. The examination of fractions dominated by prostatic secretion can start after 5–10 minutes of adjustment of temperature to 37 °C (for assessment of motility). Fractions with coagulum can be dissolved within 30 minutes at 37 °C. Fractions lacking any proteases of prostatic origin may resist liquefaction longer.

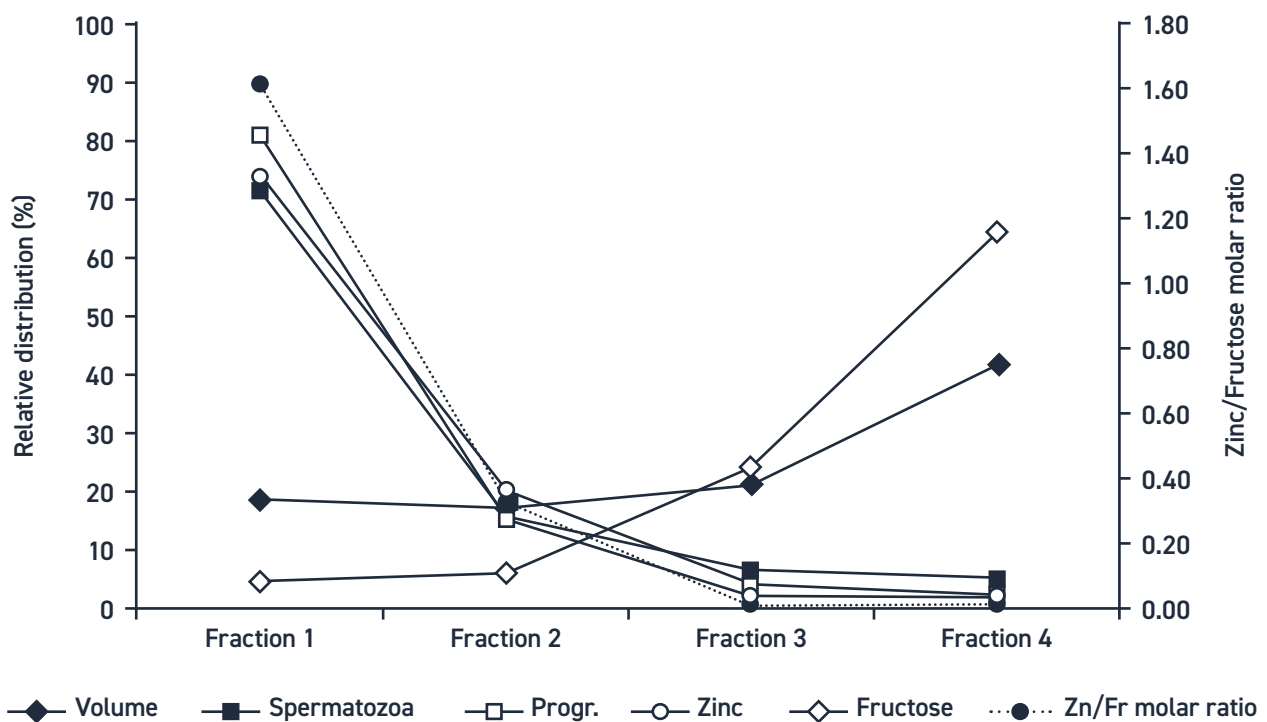
### 3.9.4 Examination

Assessment of volume, sperm count, motility, and zinc (prostatic marker) and fructose (marker for seminal vesicles) is done according to routine examination of whole ejaculates.

### 3.9.5 Calculations

Calculate the relative distribution of volume, spermatozoa, proportion of progressive spermatozoa and biochemical markers. First calculate the total numbers in each fraction, then the relative distribution in each fraction (Fig. 3.9).

Fig. 3.9 Example of graphic representation of results of a normal four-fraction split-ejaculate, showing the distribution of volume, spermatozoa, progressive motility, zinc and fructose



Reproduced with permission from *A Practical Guide to Practical Laboratory Andrology*, Cambridge University Press (273)

### 3.9.6 Interpretation

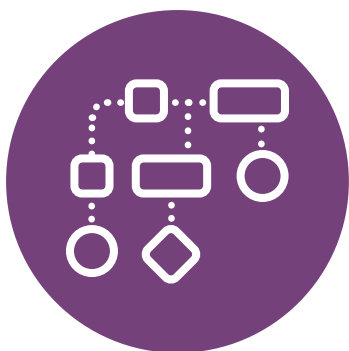
The bulk of spermatozoa are expected to be in the first third of the ejaculate, dominated by zinc-rich prostatic secretion. A substantial contribution of seminal vesicular fluid in the sperm-rich fraction(s) indicates a non-physiological situation likely to hamper sperm functional ability.

The identification of an ejaculate fraction with good progressive motility can be useful for future selection of spermatozoa for ART – a fact described long before the era of IVF (274).

Also, for laboratories unable to determine the accessory gland markers zinc and fructose, useful information can be obtained by assessing the relative distribution of spermatozoa and progressive motility, to identify possible sources of spermatozoa with a higher probability of fertilization success.







## Chapter 4: Advanced examinations

4.1 Seminal oxidative stress and reactive oxygen species testing .....	140
4.2 Assessment of the acrosome reaction .....	144
4.3 Assessment of sperm chromatin .....	149
4.4 Transmembrane ion flux and transport in sperm .....	152
4.5 Computer-aided sperm analysis (casa) .....	155
4.6 Emerging technologies .....	159

Male infertility is often due to insufficient sperm production, abnormal sperm morphology, impaired sperm motility or combinations thereof. Such phenotypes are faithfully identified by semen analysis. However, in many patients, the infertility is rather due to a dysfunction of the spermatozoa, where ejaculate examination yields parameters that appear to be completely normal. The mechanisms underlying human sperm dysfunction have remained enigmatic. Human spermatozoa have to fulfil a series of demanding tasks inside the female genital tract, and they must cover distances of several centimetres, where they might be instructed by chemical and physical cues to localize the egg. Moreover, spermatozoa have to undergo acrosomal exocytosis and hyperactivated motility to break through the egg's protective vestments. Sperm acquire most of these skills only inside the female genital tract during a maturation process called capacitation. While essential for fertilization, none of these sperm functions is assessed in a classical ejaculate examination.

“

To gain deeper insights into the biological basis of male factor infertility, a battery of functional tests has been developed aimed at assessing the competence of human spermatozoa to fulfil the fundamental processes essential to conception. ”

To close this diagnostic gap, a transfer of knowledge on molecular and cellular sperm physiology into clinics is required. In addition, implementing research in the field of male infertility is of fundamental importance nowadays, given recent literature evidencing that alterations in semen parameters may be associated with an individual's general health (275). In addition, there is current evidence that environmental contaminants are playing an important role in male infertility (276), as well as in the documented decline of sperm counts observed in the last few decades (277). Less is known regarding whether sperm functions necessary for

fertilization are also a mirror of general health and whether they are influenced by environmental contaminants. As our knowledge of the molecular mechanisms regulating sperm function increases, so too will opportunities for the development of new diagnostic tests. For example, recent data emphasize the importance of nuclear DNA compaction and integrity in determining the functional competence of human spermatozoa. Emerging evidence suggests associations between DNA integrity and chromatin organization in spermatozoa and fertility (278) (**Section 3.2 on page 86**).

Similarly, advances in our understanding of the signal transduction pathways regulating sperm function will have implications for the development of diagnostic tests capable of generating detailed information on the precise nature of the processes that are defective in the spermatozoa of infertile men. To gain deeper insights into the biological basis of male factor infertility, a battery of functional tests has been developed aimed at assessing the competence of human spermatozoa to fulfil the fundamental processes essential to conception – binding to the zona pellucida, acrosomal exocytosis, and fusion with the vitelline membrane of the oocyte.

Some tests for research purposes require that the spermatozoa are separated/selected from the seminal fluid. Such procedures should occur as soon as possible, and at least within 1 hour of ejaculation, to limit any damage to spermatozoa from non-sperm cells. Furthermore, it must be remembered that the classic way of collecting the entire ejaculate into one specimen container leads to investigations of spermatozoa exposed to unphysiological environments such as the seminal vesicular fluid (251, 252) (see also **Section 3.9 on page 135**).

## 4.1 Seminal oxidative stress and reactive oxygen species testing

### 4.1.1 Background

The hypothesis that an imbalance in reduction–oxidation reactions (REDOX) within the male tract or seminal secretions could be detrimental to fertility has been suggested for decades (279–283). It is generally accepted that reactive oxygen species (ROS) produced by leukocytes underlie their deleterious effects when present at high level in semen (**Section 3.4 on page 108**). However, there has still not been a landmark study with decisive evidence for a certain test or proof of a relationship between REDOX and natural or assisted conception outcomes. Nevertheless, it is generally accepted that oxidative stress is likely to be an important modulator of human sperm function and conception outcomes (284). As one consequence of oxidative stress is sperm DNA damage (**Section 3.2 on page 86**), this is the most often the outcome measured, but several other research methods exist that can be used to examine the balance of antioxidants and ROS more directly. From a clinical diagnostic perspective, this group of assays should only be used and interpreted with caution until more conclusive proof of their diagnostic relevance exists. The procedures presented herein have been widely used in andrology research, as well as in some andrology clinical diagnostic and assisted reproduction laboratories. Assays that can be used to evaluate REDOX balance or ROS vary in both the method and the type of ROS they are detecting.

## 4.1.2 Luminol

This method is based on the chemiluminescent response of luminol when it reacts with a free-radical. This response can be measured by luminometry and the number of relative light units (RLU) per million sperm calculated.

### 4.1.2.1 Procedure

Adapted from Dias (285):

1. Prepare 100 mM luminol (5-amino-2,3-dihydro-1,4-phthalazinedione) stock solution in 10 ml dimethyl sulfoxide (DMSO) by weighing 177.1 mg luminol in a polystyrene tube. Wrap the tube in aluminium foil, as this solution is light-sensitive. The solution should be stable at room temperature but can also be stored refrigerated.
2. Working "probe" solutions: 5 mM luminol in DMSO – by dilution of 20 µl of luminol stock solution in 380 µl DMSO. This should be prepared immediately prior to use (only stable for 24 hours). It must be protected from light.
3. The ejaculate should be allowed to liquefy before measurement (less than 30 minutes but, in accordance with WHO core ejaculate examination methods, no longer than 1 hour).
4. Measurements in luminometry should be performed in duplicate (as an absolute minimum).
  - For each ejaculate a single tube is prepared by mixing 390 µl of the ejaculate with 10 µl of the working "probe" solution. Mix by vortex for 5 seconds, before aliquoting to at least duplicate measurement tubes (or wells in a plate).
5. In all assay sets there should be:
  - blanks of **DPBS** or media alone
  - a negative control of 390 µl DPBS or media + 10 µl "probe"
  - positive controls, both with addition of 50 µl hydrogen peroxide (30%) + 10 µl "probe" of:
    - ejaculate (340 µl) or
    - DPBS or media (340 µl).
6. Data should be taken over a number of readings, equally spaced and in the order of each analyte once then repeated, according to the type of instrument, and an average calculated.
7. Positive controls can be used to assess the sensitivity of the assay in the specific setting, via dilution series, and also confirm in any given assay set that detection of a meaningful result would occur.



8. Data are normalized by subtracting the mean result for the sample from the mean negative control. This can be corrected to per sperm by division by sperm concentration in millions per ml, but it is unclear at the time whether per sperm results have more meaning or not than per sample, so both results could be quoted.

#### 4.1.2.2 Issues

- Luminometers are generally not accredited for in vitro diagnostics, being for research only.
- The design of instruments (such as volume of sample) and thereby calibration, sensitivity, dynamic range and even units used vary widely.
- Due to the described variation between machines and methodologies and the low quality of studies for prognosis, there are no agreed reference values.
- Shearing forces/mixing change the signal, so results are very sensitive to the handling of the sample and timing of measurement.
- Luminol is sensitive to pH, temperature changes, and interference from chemicals that often vary between ejaculates such as ascorbic acid (decrease signal) or thiol-containing molecules (which increase results) and levels of other protein present.

#### 4.1.3 Oxidation-reduction potential

This method is based on direct measurement of the REDOX balance of a sample by electrochemical means. As an integrating measurement of the combined sample that requires minimal manipulation and therefore is quite standardizable, it is currently a topic for much research in subfertility. Currently only one machine exists on the market which has patent protection. It uses single-use sensors for measurement. In use the latest protocols from the manufacturer should be used, which are beyond the discussion in this manual.

##### 4.1.3.1 Issues

- There is a lack of a published strong evidence base for the assay; it is still currently regarded as a research test until conclusive data related to reproductive outcome emerge.
- Sample viscosity and poor liquefaction may hamper flow of the sample and so filling of the reference chamber.
- As for all semen assays, the time of analysis after ejaculation should be standardized.

#### 4.1.4 Total antioxidant capacity

This method is designed to assess the ability of the entirety of the ejaculate to balance any oxidative stress. This is therefore measuring the ability of antioxidant enzymes and systems within the seminal plasma, as well as any antioxidants derived from



food or otherwise that end up in the seminal plasma (but not the sperm; these are removed by centrifugation). In the assay the antioxidants present inhibit the oxidation of 2'-azinobis-(3-ethyl-benzthiazoline sulfonic acid) (ABTS) by a radical cation. It was developed to be, and is, used across many body fluids and is therefore not semen specific (286). Trolox, an analogue of Vitamin E (tocopherol), is used to create a standard range, so the assay is usually expressed as micromoles of Trolox equivalent. The assay is read as colourimetric, so an appropriate analyser is required.

#### 4.1.4.1 Procedure

1. Due to its ubiquitous use across many systems beyond fertility, the assay is available as pre-packaged kits from a number of suppliers. The instructions for the relevant kits should be followed. It is also possible to construct the kits from the separate constituent ingredients purchased separately.
2. The ejaculate should be allowed to liquefy completely and then centrifuged at > 1000g for 15 minutes. The clear seminal plasma can then be removed. 10 µl of this plasma can be checked to confirm that no sperm are present. If any sperm are present, centrifuge again.
3. Clear seminal plasma can be aliquoted and directly frozen for later analysis. This may be advantageous in allowing for batching of the assay. The stability of results at any given freezing temperature should be checked and validated by the laboratory performing the assay.
4. In preparing for assay measurements, all ingredients should be brought to room temperature in advance. The assay constituents are all light-sensitive, so light should be minimized as much as possible – such as by turning laboratory lights off – while the assay is set up and performed.
5. Measurements should be performed in duplicate (as an absolute minimum). Absorbance is read at 750 nm.

#### 4.1.4.2 Issues

- There is a strong, solid, clearly defined literature for the assay procedure and agents which can affect results across systems (287), but in terms of using this assay to draw a medical conclusion around male semen parameters and effects of ROS on fertility, it is still currently regarded as a research test until conclusive data related to reproductive outcome emerge.
- Due to variation between machines and methodologies and the low quality of evidence for prognosis, there are no evidence-based reference limits.
- Ideally the assay is read in a microplate reader due to the number of duplicates and standards.



## 4.2 Assessment of the acrosome reaction

### 4.2.1 Background

The integrity of the acrosome structure and the ability to undergo acrosomal exocytosis are necessary for normal fertility. The acrosome reaction is a process that in vivo occurs in the proximity of the oocyte, and which must take place before the spermatozoon can penetrate the oocyte vestments and fuse with the oocyte. Calcium influx is believed to be an initiating event in the normal acrosome reaction. In cases of teratozoospermia and oligozoospermia, some patients may have otherwise normal results of ejaculate examination, but spermatozoa may display alterations in the acrosomal structure or in the ability to respond to stimuli of acrosome reaction (288).

Several stimuli are known to induce acrosome reaction. Among these, zona pellucida proteins (289) and progesterone (290) are considered possible physiological inducers of acrosome reaction in view of their elevated concentration in the proximity of the oocyte. Other stimuli, such as calcium ionophores, will induce the acrosome reaction, but the results are not or less related to those obtained from the zona pellucida-induced acrosome reaction (291). A recent meta-analysis (288) demonstrated a significant correlation of the percentage of acrosome-reacted spermatozoa following induction with stimuli with fertilization rate. Acrosomal status after induction of the acrosome reaction can be assessed by microscopy or flow cytometry (292) with fluorescently labelled lectins, such as *Pisum sativum* (pea agglutinin) (Section 4.4.1 on page 152) or *Arachis hypogaea* (peanut lectin), or monoclonal antibodies against the acrosome antigen CD46 (293). Inducing calcium influx by using an inducer of acrosome reaction is one way of testing the competence of capacitated spermatozoa to undergo the acrosome reaction (294, 295). However, further validation and evaluation are needed before testing of acrosome status can be considered a routine clinical assay.

Here, the procedures for static assessment of acrosome status and dynamic, induced acrosome reaction will be described.

### 4.2.2 Assessment of acrosome status

#### 4.2.2.1 Procedure

The method was originally developed by Cross (296), based on the study by Mortimer et al. (297), who demonstrated that *Arachis hypogaea* (peanut) agglutinin (FITC-PNA) binds the outer acrosomal membrane of spermatozoa. The method was subsequently modified by Aitken (294), introducing hypo-osmotic swelling reagent (Section 2.5.13.2 on page 69) to evaluate acrosome reaction only in live spermatozoa. The procedure is simple and reproducible and produces very clear images (Fig. 4.1 on page 147). It is preferable to use a highly motile sperm preparation free from contaminants such as leukocytes, germ cells and dead spermatozoa. Thus, either the sample should be washed (Section 5.3 on page 164) or swim-up or density-gradient preparations (Section 5.4 on page 165 and Section 5.5 on page 166) should be made, depending on the quality of the sample and on the study protocol to be followed.



#### 4.2.2.2 Reagents

- *Pisum sativum* agglutinin (PSA) labelled with fluorescein isothiocyanate (FITC) (PSA-FITC)
- *Arachis hypogaea* (peanut) lectin agglutinin labelled with fluorescein isothiocyanate (FITC) (AHLFNA-FITC)
- **DPBS**, pH 7.4
- 0.9% (9 g/L) NaCl: dissolve 0.9g of NaCl in 100 ml of purified water
- 95% (v/v) ethanol
- PSA and AHLFNA stock solution: dilute 2 mg of PSA-FITC or AHLFNA-FITC in 4 ml of DPBS and store in 0.5-ml aliquots at -20 °C
- PSA working solution: dilute 0.5 ml of PSA stock solution in 10 ml of DPBS and store at 4 °C. This solution is stable for up to 4 weeks.

#### 4.2.2.3 Simple washing of spermatozoa

1. Mix the semen sample well and remove an aliquot of about 0.2 ml.
2. Dilute to 10 ml with 0.9% (9 g/L) saline.
3. Centrifuge at 800g for 10 minutes.
4. Tip off and discard all but 20–40 µl of the supernatant.
5. Resuspend the sperm pellet in the remaining supernatant by gentle pipetting.
6. Repeat the washing procedure.

#### 4.2.2.4 Treating purified sperm preparations

1. Dilute swim-up (**Section 5.4 on page 165**) or once-washed density-gradient preparations (**Section 5.5 on page 166**) to 10 ml with buffer to obtain 10 million/ml concentration.
2. Centrifuge at 800g for 10 minutes.
3. Tip off and discard all but 20–40 µl of the supernatant.
4. Resuspend the sperm pellet in hypo-osmotic swelling buffer for 30 minutes.
5. Centrifuge at 800g for 10 minutes.
6. Tip off and discard the supernatant, and resuspend in a small volume of buffer by gentle pipetting.



#### 4.2.2.5 Preparing a smear

1. Prepare replicate sperm smears about 1 cm long from about 5 µl of suspension.
2. Inspect the wet smears by phase-contrast microscopy (×400).
3. Ensure that the spermatozoa are evenly distributed on the slides without clumping.
4. Allow to air-dry.
5. Fix in 95% (v/v) ethanol for 30 minutes.
6. Allow to air-dry.

#### 4.2.2.6 Staining with PSA-FITC

1. Pour 10 ml of PSA-FITC or AHL-FITC working solution into a vertical staining jar.
2. Immerse the fixed and air-dried slides in the PSA-FITC stain.
3. Allow to stain for more than 1 hour at 4 °C. Longer staining times – up to 18 hours – will not affect PSA results. Shorter times – less than 1 hour – will make it difficult to score the slide.
4. Wash each slide with purified water and mount in water-soluble medium (**Section 2.4.9.5 on page 48**).

#### 4.2.2.7 Scoring

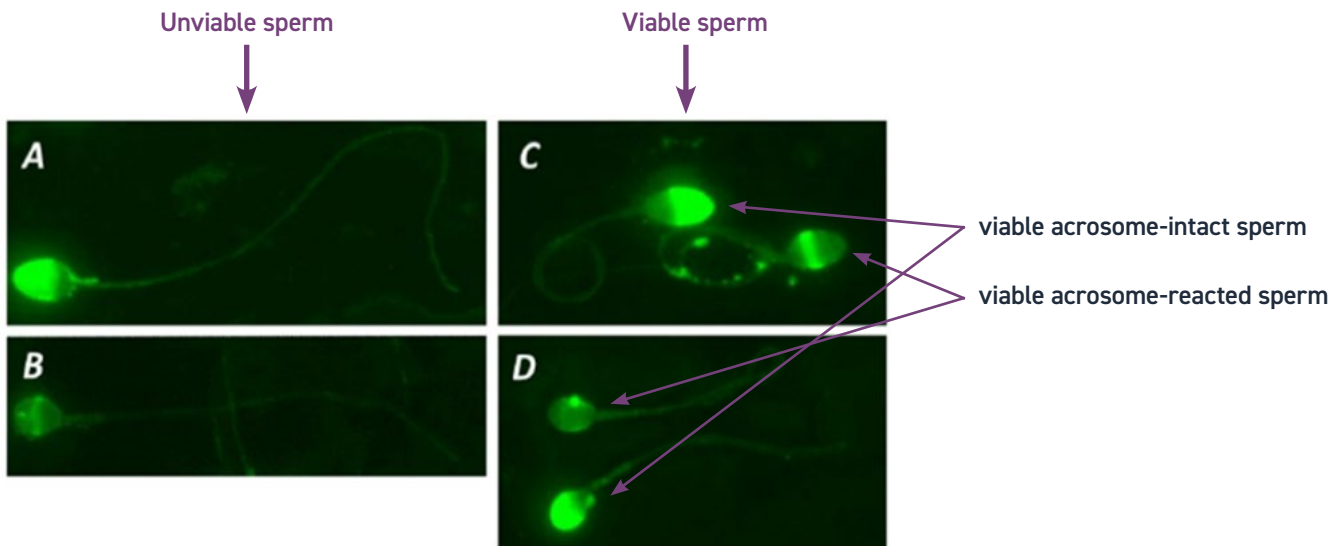
View the slide with fluorescence optics at ×1000 magnification with oil immersion at 450–490 nm excitation and suitable dichroic and filter combination to observe the 519 nm emission peak.

Categorize the spermatozoa as follows:

- live acrosome-intact: spermatozoa with curly tail in which more than half the head is brightly and uniformly fluorescing (Fig. 4.1); and
- live acrosome-reacted: spermatozoa with curly tail showing only a fluorescing band at the equatorial segment or no fluorescing stain at all in the acrosome region (Fig. 4.1).
- Usually dead sperm are not scored in this assay, but monitoring the percentage of dead cells alongside may allow troubleshooting of any errors in scoring/processing between individuals performing the assay. The percentage of dead cells would not be expected to be significantly different from that in the originating semen.



Fig. 4.1 Examples of FITC-PNA-stained acrosome-intact and acrosome-reacted, viable and unviable spermatozoa



Acrosome-intact spermatozoa, with stained proximal heads (acrosome), and acrosome-reacted spermatozoa, with stained equatorial bands or post-acrosomal regions, are shown. Curly tails indicate sperm viability after HOS procedure (also see **Section 2.5.13.2 on page 69**).

#### 4.2.2.8 Counting acrosome-reacted spermatozoa

1. Tally the number in each acrosomal category (acrosome-intact and acrosome-reacted) with the aid of a laboratory counter.
2. Evaluate 200 spermatozoa in each replicate, to achieve an acceptably low sampling error.
  - Calculate the average and difference of the two percentages of acrosome-reacted spermatozoa from the replicate slides.
  - Determine the acceptability of the difference from **Table 2.3 on page 33**, the maximum difference between two counts that is expected to occur in 95% of samples because of sampling error alone.
  - If the difference between the percentages is acceptable, report the average percentage of acrosome-reacted spermatozoa. If the difference is too high, reassess the two slides.
  - Report the percentage of acrosome-reacted spermatozoa to the nearest whole number.

#### 4.2.3 Induced acrosome reaction assay

Acrosome reaction can be induced by using ionophores (Acrosome Reaction following Ionophore Challenge, ARIC) (298) or by using progesterone (Acrosome Reaction following Progesterone Challenge, ARPC) (290) or other stimuli.

### 4.2.3.1 Reagents

- Supplemented Earle's balanced salt solution (**sEBSS** – see **Section 8.4 on page 225**) containing 3.0% (30 g/L) BSA Note: If undertaking progesterone induction, delipidated/charcoal-stripped serum should be used to avoid effects of other lipid-soluble molecule (including hormone) contamination.
- Dimethyl sulfoxide (DMSO)
- Ionophore A23187, 1 mmol/L stock solution: dissolve 5.23 mg of A23187 in 10 ml of DMSO, progesterone 2–10 µg/ml (299) or other acrosome reaction inducers (288). Note: Legal requirements may exist regarding safety precautions, and risks should be carefully assessed before using ionophore.
- 70% (v/v) ethanol.

### 4.2.3.2 Procedure

1. Allow 30–60 minutes for complete liquefaction of the fresh semen.
  2. Prepare the sEBSS capacitation-inducing medium fresh for each assay.
  3. Warm the medium to 37 °C before use, preferably in a 5% (v/v) CO<sub>2</sub> in air incubator.
  4. Prepare a highly motile sperm population, free from contaminants such as leukocytes, germ cells and dead spermatozoa, by density-gradient centrifugation (DGC) (**Section 5.5 on page 166**) or swim-up using fresh sEBSS medium.
  5. Prepare control and replicate experimental tubes, each containing approximately 1 ml of suspension with 1×10<sup>6</sup> motile spermatozoa.
  6. Incubate the sperm suspensions for 3 hours at 37 °C in an atmosphere of 5% (v/v) CO<sub>2</sub> in air to induce capacitation (loosen the cap of the tube to allow gas exchange). If a CO<sub>2</sub> incubator is not available, use a **HEPES**-buffered medium (**Section 8.4 on page 225**), cap the tubes tightly and incubate at 37 °C in air.
  7. Add 10 µl of A23187 stock solution (1 mmol/L) to the replicate experimental tubes to yield a final concentration of 10 µmol/L.
  8. Add 10 µl of DMSO to the control tube.
  9. Incubate all the tubes at 37 °C for 15 minutes.
  10. Remove a small aliquot from each tube for motility determination.
  11. Next steps as for prepared sperm (**Section 4.2.2.4 on page 145**).
- Process (**Sections 4.2.2.5 and 4.2.2.6**), score (**Section 4.2.2.7**) and count (**Section 4.2.2.8**) as described above on pages 146–147.

### 4.2.3.3 Quality control

- A positive control sample (semen from a man whose spermatozoa have previously responded well to ionophore or progesterone) should be run each time the test is performed.
- Each time a new batch of stain is prepared, perform a crossover test with the old stain, using positive control spermatozoa with a known response, to ensure that the stain has been made properly.

## 4.3 Assessment of sperm chromatin

### 4.3.1 Background

The stability of the sperm chromatin structure is of fundamental importance for embryo development and quality, probably due to protection of and rapid availability of the paternal genome (300). Disturbance of the stability of the sperm chromatin is associated with lower fertilization in assisted reproduction (301). Abnormalities in sperm chromatin structure may cause sperm DNA damage, such as double or single DNA strand breaks, because of faulty DNA compaction (i.e. abnormalities in histone replacement by protamines). The normality of sperm chromatin can be evaluated either by assessment of DNA strand breaks (Section 3.2 on page 86) or by dyes that bind to histones (aniline blue) or nucleic acid (chromomycin A3) and are assessed histologically or by flow cytometry.

### 4.3.2 Aniline blue assessment

Aniline blue (AB) binds to lysine residues of histones. The percentage of spermatozoa stained with AB can be evaluated in either whole semen or selected (swim-up or density-gradient prepared (see Section 5.5 on page 166)) spermatozoa.

#### 4.3.2.1 Protocol

##### Reagents

- AB powder is dissolved in water containing 4% glacial acetic acid (pH 3.5) at the final concentration of 5%.

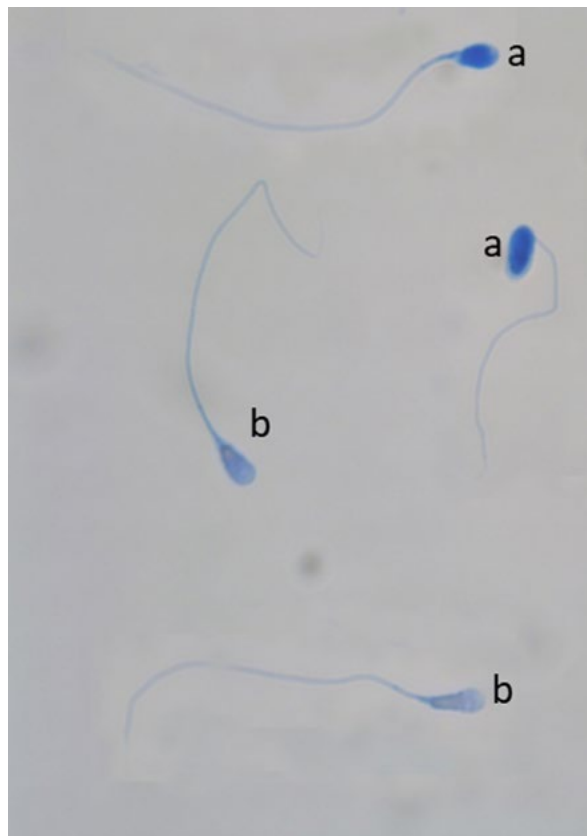
##### Procedure

1. Take  $1 \times 10^6$  spermatozoa (not less than 200 000 spermatozoa, in case 1 million is not available).
2. In case of whole semen, wash spermatozoa twice in any sperm culture medium (Section 5.3 on page 164) (centrifuge at 500g for 5 minutes at room temperature). In case of selected spermatozoa, centrifuge once at 500g for 5 minutes.
3. Remove supernatant and fix the pellet in 50  $\mu$ l of 4% paraformaldehyde (final concentration: 200 000 spermatozoa/10  $\mu$ l) for 30 minutes at room temperature.
4. Place a 10- $\mu$ l droplet of the sample and let air-dry.
5. Immerse the slide in AB solution for 7 minutes at room temperature.



6. Wash the slide twice in water to eliminate excessive dye.
7. Let the slide air-dry.
8. Assess under an optic microscope, oil immersion ( $\times 100$  objective and  $\times 10$ – $12.5$  ocular magnification). At least 200 spermatozoa should be scored.

**Fig. 4.2 Example of AB-positive (a) and AB-negative (b) spermatozoa at optical microscopy ( $\times 1000$ , oil immersion)**



From Marchiani et al. (302)

#### 4.3.2.2 Issues

- Scoring may be difficult in some cases. In particular, difficulties can be encountered in case of sperm agglutination.
- Scoring is operator-dependent.

#### 4.3.3 Chromomycin A3 assessment

Chromomycin A3 (CMA3) competes with protamines for binding to the minor groove of the DNA helix. The percentage of spermatozoa stained with CMA3 can be evaluated in either whole semen or spermatozoa selected by swim-up.

### 4.3.3.1 Protocol

#### Reagents

1. Prepare stock solution of CMA3:

- Prepare McIlvaine buffer (20 ml to be stored at room temperature):
  - Add 16.47 ml of a solution of  $\text{Na}_2\text{HPO}_4$  0.2 M and 3.53 ml of a solution of citric acid 0.1 M10.
  - Add  $\text{MgCl}_2$  to reach a final concentration of 10 mM. pH should be 7.0.
- Dissolve 5 mg of CMA3 powder in 10 ml of McIlvaine buffer to obtain a 2× stock solution. Aliquots of CMA3 stock solution can be stored at  $-20^\circ\text{C}$ .

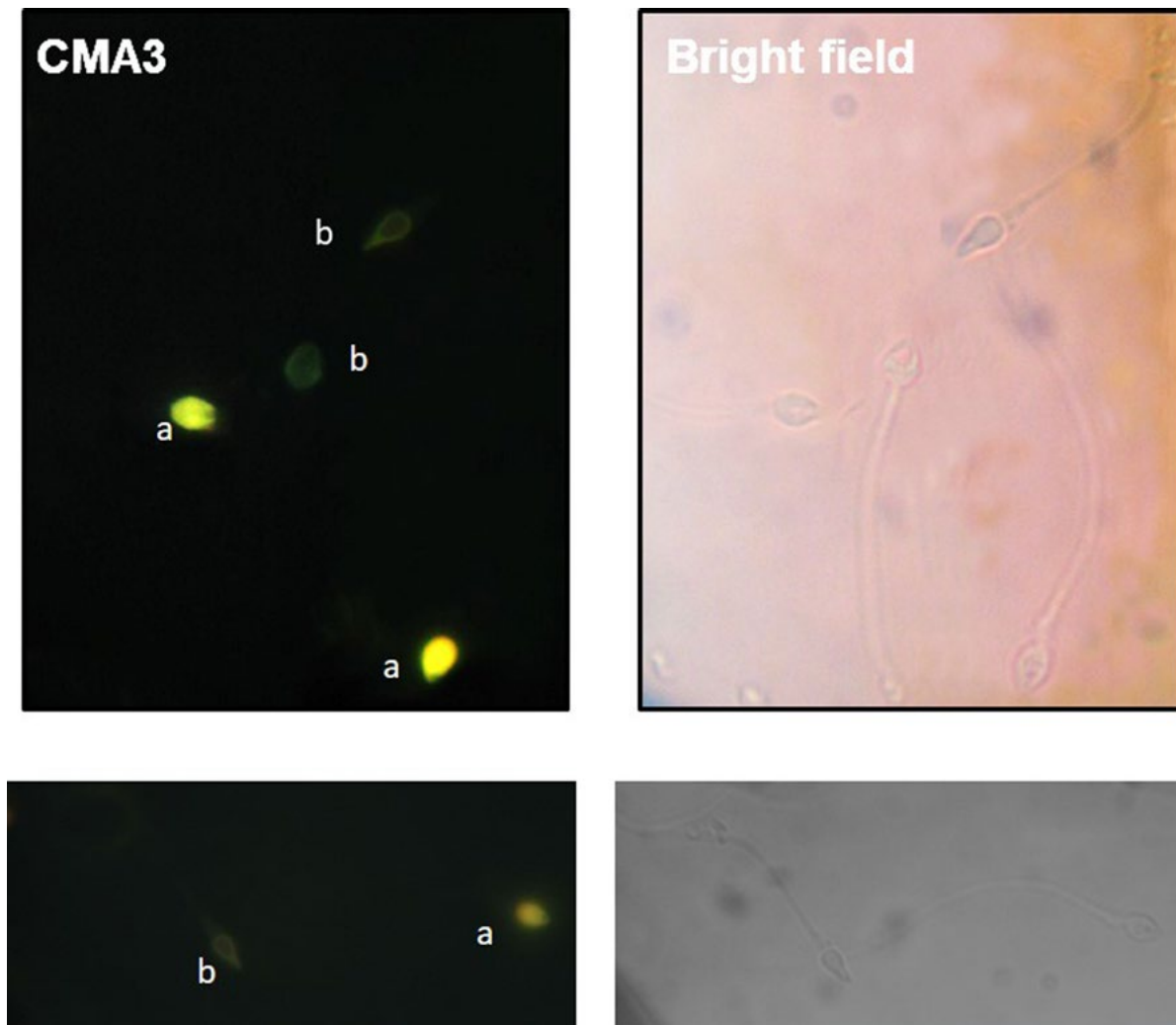
2. At the moment of use, dilute sperm aliquots 1 : 1 in McIlvaine buffer to obtain a final concentration of CMA3 of 0.25 mg/ml.

#### Procedure

1. Take  $1 \times 10^6$  spermatozoa (not less than 400 000 spermatozoa, in case 1 million is not available).
  - In case of whole semen, wash spermatozoa twice in any sperm culture medium (**Section 5.3 on page 164**) and centrifuge at 500g for 5 minutes at room temperature.
  - In case of selected spermatozoa, centrifuge once at 500g for 5 minutes.
2. Remove supernatant and fix the pellet in 50  $\mu\text{l}$  of 4% paraformaldehyde (final concentration: 400 000 spermatozoa/10  $\mu\text{l}$ ) for 30 minutes at room temperature.
3. Take 20  $\mu\text{l}$  of the sample and centrifuge at 300g for 7 minutes at room temperature.
4. Remove supernatant and wash once in **DPBS** by centrifuging at 300g for 7 minutes at room temperature.
5. Remove supernatant, add 100  $\mu\text{l}$  CMA3 solution (0.25 mg/ml) and incubate for 20 minutes at room temperature.
6. Add 200  $\mu\text{l}$  McIlvaine buffer and centrifuge at 300g for 7 minutes at room temperature.
7. Discard supernatant, resuspend the pellet in 10  $\mu\text{l}$  McIlvaine buffer and place on a slide.
8. Let the drop air-dry, add a drop of DPBS and place a coverslip over it.
9. Read at 1000× magnification (oil immersion) with a fluorescence microscope (excitation wavelength: 445 nm, emission wavelength: 575 nm). At least 200 spermatozoa should be scored.



Fig. 4.3 Examples of CMA3-positive (a) and CMA3-negative (b) spermatozoa (left panel)



In the right panel (Bright field) it is possible to visualize the presence of CMA3-negative spermatozoa in the same field.

Adapted from Marchiani et al. (303)

#### 4.3.3.2 Issues

- Scoring may be difficult in some cases. In particular, difficulties can be encountered in case of sperm agglutination or with fluorescent background.
- Scoring is operator-dependent.

## 4.4 Transmembrane ion flux and transport in sperm

### 4.4.1 Background

Functional analysis of transmembrane ion flux and transport in sperm may be a way forward in the search for diagnostic tools to better understand male factor infertility and disorders of the male reproductive organs. Navigation,

capacitation, hyperactivation and acrosomal exocytosis are orchestrated by changes in intracellular pH ( $pH_i$ ), membrane voltage ( $V_m$ ) and intracellular  $Ca^{2+}$  concentration ( $[Ca^{2+}]_i$ ). These signalling events are mediated by the interplay of unique, mostly sperm-specific ion channels, exchangers and transporters, e.g. CatSper  $Ca^{2+}$  channels, Slo3  $K^+$  channels,  $H_v1$   $H^+$  channels,  $Na^+/H^+$  exchangers (sNHE, NHA1, NHA2),  $Ca^{2+}$  ATPases (PMCA4) and  $Mg^{2+}$  transporters (CNNM2, CNNM4). Many cases of as yet unexplained sperm dysfunction might be due to the defective function of one or more of these proteins. Supporting this notion, genetic aberrations affecting CatSper genes, defective CatSper function or expression, and defective  $K^+$ -channel function have been associated with male infertility (304). So far, routine diagnostic procedures to assess the function of ion channels, exchangers and transporters in sperm from patients are lacking. However, research protocols have been developed to investigate (with low to medium throughput) the activity of ion channels in sperm from patients within the framework of clinical studies.

#### 4.4.2 Electrophysiology and kinetic $Ca^{2+}$ fluorimetry to assess the function of CatSper

The sperm-specific, progesterone-activated CatSper channel controls the influx of  $Ca^{2+}$  into the flagellum, thereby affecting the swimming behaviour. Loss of CatSper function is associated with male infertility and IVF failure (304-307), suggesting that CatSper-dysfunctional sperm can fertilize only using ICSI.

The function of CatSper in human sperm can be studied by electrophysiology and kinetic  $Ca^{2+}$  fluorimetry, respectively. Motile sperm are purified by the swim-up procedure or DGC. Electrophysiological recordings of CatSper currents from human sperm are performed in solutions lacking divalent ions in the whole-cell configuration, with the glass electrode positioned at the cytoplasmic droplet or neck region. Once a gigaohm (a measure of electric resistance,  $G\Omega$ ) seal and the whole-cell configuration are established, prototypical monovalent CatSper currents can be evoked by depolarization of the membrane voltage. The lack of significant attenuation of these currents indicates CatSper dysfunction.

For  $Ca^{2+}$  fluorimetry, sperm in suspension are loaded with a fluorescent  $Ca^{2+}$  indicator dye (e.g. Fura-2 or Fluo-4). To remove excess extracellular indicator after loading, sperm are sedimented by centrifugation and resuspended in fresh buffer, and  $[Ca^{2+}]_i$  of the sperm in suspension is monitored via the indicators' fluorescence emission, e.g. in microtitre plates or a cuvette using a fluorescence plate reader or spectrometer, respectively. The fluorescence emitted by the  $Ca^{2+}$  indicator is recorded before and after injection of a CatSper agonist (e.g. progesterone, prostaglandins), buffer (negative control) and the  $Ca^{2+}$  ionophore ionomycin (positive control) into the wells or the cuvette. Failure of the CatSper agonist(s), but not ionomycin, to increase the fluorescence, i.e.  $[Ca^{2+}]_i$ , is indicative of a loss of CatSper function. Only recently, this technique identified two infertile patients suffering from a loss of CatSper function. Genetic diagnostics revealed that the loss of CatSper function and, thus, the infertility was due to a genetic aberration affecting a CatSper gene. Of note, also single-sperm  $[Ca^{2+}]_i$  imaging was used to study CatSper in sperm from patients to gain information on individual sperm, e.g. the fraction of responsive cells and the presence of subpopulations. This finding revealed that a reduced sensitivity to progesterone is common in subfertile patients and correlates with fertilization rate (308).

### 4.4.3 Electrophysiological and fluorimetric methods to study the function of K<sup>+</sup> channels

The function of K<sup>+</sup> channels, i.e. Slo3, in human sperm can be studied with low and medium throughput using whole-cell patch-clamp recordings and V<sub>m</sub> fluorimetry, respectively. Slo3 represents the principal K<sup>+</sup> channel in human sperm. It is activated by Ca<sup>2+</sup> and, thereby, sets the membrane potential of human sperm in a [Ca<sup>2+</sup>]<sub>i</sub>-dependent fashion.

In electrophysiological whole-cell recordings, using extracellular solutions containing divalent ions to suppress CatSper currents and a K<sup>+</sup>-based pipette solution, prototypical Slo3 currents can be evoked by depolarization of the membrane voltage. This approach led to the discovery of several patients with abnormal K<sup>+</sup> channel activity and depolarized resting membrane potential as well as a low fertilization rate in IVF.

A medium-throughput screening approach to assess K<sup>+</sup> channel activity in sperm relies on voltage-sensitive fluorescent indicators. These indicators report V<sub>m</sub> changes as changes in their fluorescence emission, e.g. by a V<sub>m</sub>-dependent redistribution between the extracellular medium and the cytoplasm. For the screening, sperm – either purified or diluted from the ejaculate – are incubated with the indicator for some minutes. Afterwards, fluorescence is recorded either in population in microtitre plates or a cuvette using a fluorescence plate reader or a spectrometer, respectively, or on a single-cell level using flow cytometry. Subsequently, sperm are challenged with the K<sup>+</sup>-ionophore valinomycin and solutions containing different K<sup>+</sup> concentrations. Valinomycin sets the membrane potential to the respective K<sup>+</sup>-Nernst potential. Thereby, the fluorescence can be converted into V<sub>m</sub> values, allowing quantification of the sperm's resting membrane potential (V<sub>rest</sub>), dubbed K<sup>+</sup> null-point calibration. Several studies that used this approach to determine V<sub>rest</sub> and, thereby, indirectly K<sup>+</sup>-channel activity in human sperm suggested a relationship between V<sub>rest</sub> and the fertilization rate in IVF.

#### 4.4.4 Methods to detect (mal)-function of ion transporters and exchangers

Thus far, there are no techniques to assess with reasonable throughput the activity of ion exchangers and transporters in human sperm. Therefore, their role in sperm dysfunction has remained elusive.

#### 4.4.5 Summary

In the past decade, new and emerging technologies have demonstrated that sperm function – and, thereby, fertilization – is orchestrated by a unique set of mostly sperm-specific ion channels, transporters and exchangers. However, dysfunctions of these key signalling components cannot be detected by a routine semen analysis. For most of these proteins, functional tests are lacking, and current techniques to assess CatSper or Slo3 function are too demanding to be implemented in the clinical laboratory. Thus, to gain further insight into the pathological mechanisms underlying sperm dysfunction, a set of novel, easy-to-use tests suited to a seamless integration into the framework of current semen analysis is required.





## 4.5 Computer-aided sperm analysis (CASA)

### 4.5.1 Using CASA to assess sperm motility

#### 4.5.1.1 Background

CASA systems are best used for the kinematic analysis of spermatozoa, as they can detect and analyse motile cells. Estimates of percentage motility may be unreliable, as they depend on determining the number of immotile spermatozoa, and debris may be confused with immotile spermatozoa.

Many factors affect the performance of CASA instruments, e.g. sample preparation, frame rate, sperm concentration and counting-chamber depth (45, 46, 136, 309, 310). Nevertheless, reliable and reproducible results can be obtained if appropriate procedures are followed (309). Guidelines on the use of CASA (311, 312) should be consulted, and all members of staff should be trained properly in both the use of CASA equipment and the strengths and weaknesses of the technology.

In using CASA to obtain movement parameters, the tracks of at least 200 motile spermatozoa per specimen should be analysed. This implies that many more spermatozoa will need to be detected. If the spermatozoa are to be categorized by type of motion, or if other analyses of variability within a specimen are planned, the tracks of at least 200, and if possible 400, motile spermatozoa will be needed.

The CASA instrument should be linked to computer software that permits data organization and statistical analysis. The distributions of many of the movement parameters are not Gaussian; the median, rather than the mean, is therefore more appropriate as a summary of the central tendency of each variable. The measurements on single spermatozoa may need to be mathematically transformed before certain statistical analyses are done.

#### 4.5.1.2 Procedure

Each CASA unit must be correctly installed to ensure optimal operation. Manufacturers indicate specific settings, but users should verify that the tool is working, to provide the necessary degree of reliability and reproducibility. The use of suitable QC materials, such as video recordings, is essential (Section 8.6.2 on page 235). Some authors discuss CASA systems in their work (46, 309, 312-314).

#### 4.5.1.3 Sperm sample preparation

Sperm samples for CASA should be collected and prepared as described in Chapter 2. The CASA system must maintain the sample at a stable 37 °C, as human sperm movement is exquisitely sensitive to temperature changes. Characteristics of motility and sperm concentration can be assessed in undiluted ejaculate, provided there is not an excess of debris or other contaminants. Sperm motility can be calculated on samples with sperm concentration from  $2 \times 10^6$ /ml to  $50 \times 10^6$ /ml (102), depending on the CASA system. Errors can often occur in samples with a high sperm concentration (e.g. greater than  $50 \times 10^6$ /ml). Such samples should be diluted, preferably with seminal fluid from the same patient. If this is an analysis of raw semen:



1. Centrifuge a portion of the sperm sample at high speed (up to 16 000g or maximum available) for 6 minutes to obtain sperm-free seminal fluid.
2. Dilute the native semen sample with pure seminal plasma to achieve a concentration below  $50 \times 10^6$ /ml.

It should be noted that this may still change the properties of the semen; therefore, motility parameters which are governed by fluid dynamic effects (viscosity, viscoelasticity) or other environmental factors could be subject to alteration.

Disposable counting chambers with a depth of 20  $\mu\text{m}$  provide reliable motility results, and usually two chambers should be scored. Several representative fields of view should be analysed. How the exact choice of these fields affects results has not been studied in detail. However, the fields should be across the area of the chamber, and systems suggest that a minimum analysis of six fields of view per chamber (12 fields of view in total) usually gives a reliable result. If possible, at least 200 motile sperm should be evaluated in each chamber. Similar principles of QC are used as a standard assessment of motility (**Section 2.4.6 on page 23**). Samples can be analysed either immediately or after recording. Analysis of recordings lends itself to better standardization and QC procedures (**Section 8.6.2 on page 235**).

There is some disagreement as to how long sperm should be observed to achieve accurate results, but at least 1 second is enough for basic CASA measurements (46). The duration of observation of swimming cells can have a significant impact on results (315); comparisons between analyses of different lengths must be done with care.

#### 4.5.1.4 CASA terminology

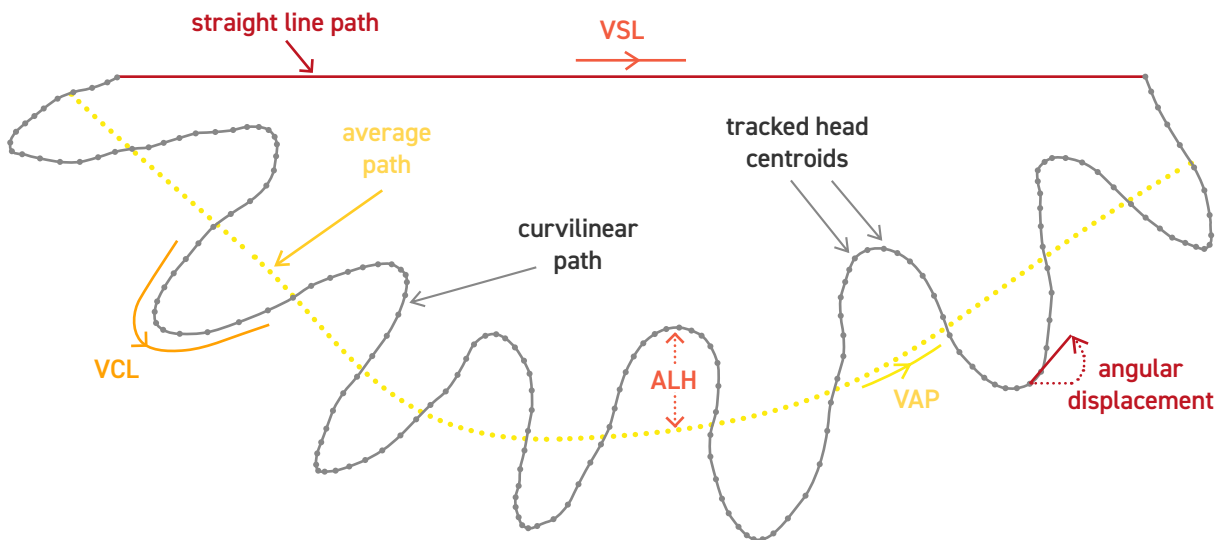
Some standard variables measured with CASA systems, as shown in Fig. 4.4, are:

- VCL, velocity along the curvilinear path ( $\mu\text{m/s}$ ): the time-averaged velocity of the sperm head moving along the path traced out by the sperm as described in two dimensions under a microscope;
- VSL, velocity along the straight-line path ( $\mu\text{m/s}$ ): the velocity calculated along a straight line between the first and last points of the path;
- VAP, velocity along the average path ( $\mu\text{m/s}$ ): the time-averaged velocity calculated along the average path. This is defined as a smooth curved path, calculated according to the algorithm embedded in the CASA system; these algorithms are different in different systems, so the values may not be comparable between systems, or with different acquisition parameters such as framerate.
- ALH, the amplitude of the lateral displacement of the head ( $\mu\text{m}$ ): the magnitude of the lateral displacement of the sperm head about the average path. ALH is often expressed as the maximum or average value of such displacements. Different CASA systems calculate ALH using different algorithms, so the values may not be comparable.
- MAD, mean angular displacement (degrees): time-averaged absolute values of the instantaneous angle of rotation of the curvilinear path. It should be noted that this does not measure the turning angle of the direction in which the sperm head is pointing.



- Other, commonly used, measures are derived from the calculation of these five variables:
  - LIN, linearity: linearity of the curvilinear path (straight-line velocity / curvilinear velocity);
  - WOB, wobble: a measure of oscillation of the curvilinear path about the average path (average path velocity / curvilinear velocity);
  - STR, straightness: linearity of the average path (straight-line velocity / average path velocity); and
  - BCF, beat-cross frequency (Hz): the average frequency at which the curvilinear path crosses the average path. However, it should be noted that BCF has been shown to not correlate with flagellar beat frequency (316).
  - D, fractal dimension: the quantitative assessment of the “space-filling” properties of curves on a plane (310).

Fig. 4.4 Standard terminology for variables measured by CASA systems



**Note:** Different CASA instruments use different mathematical algorithms to compute many of these movement variables. The comparability of measurements across all instruments is not yet known.

#### 4.5.2 Using CASA to evaluate sperm hyperactivation

Hyperactivation is an important biological phenomenon of human sperm manifested through capacitation (the process of acquiring the ability to fertilize) and comprising a behavioural change in the flagellar waveform. Hyperactivation is usually characterized by an increased amplitude of flagellar beating, decreased beat frequency, and a non-progressive side-to-side yaw (317).

The complex parameters of the flagellar movement of hyperactivated spermatozoa prove difficult to reliably and unambiguously identify through manual analysis. As a result, authors have proposed various algorithms and computer-based systems for quantitative analysis of the movement of individual spermatozoa to assess the stereotypes of motility. These analyses have been based on derived quantities

by tracking head movement (318, 319). Modern computational capabilities allow simultaneous assessment of the kinetic parameters of thousands of sperm and their classification (320). Direct measurement of the flagellar waveform can also be used to more accurately comprehend the change in kinematic parameters during hyperactivation (321).

#### 4.5.3 Using CASA to evaluate sperm morphology

Image analysis has the potential to bring about major advances in quantification, objectivity and reproducibility in the assessment of sperm morphology. Commercial systems are available for quantifying the morphology of the sperm head and midpiece, and possibly the principal piece. However, tail defects affecting motility can be more directly assessed by using CASA to measure motility and motion. Use of CASA systems for morphological assessment relies on a high level of standardization and quality of staining of cells, with results easily biased due to variation in staining. For this reason, automated staining systems may often be a sensible pairing for CASA for morphology, to help eliminate variation.

Automated morphology analysis systems have the potential for greater objectivity, precision and reproducibility than manual systems (95). Precision and reproducibility can be at least as high as 92% (322), which is superior to manual evaluation by an experienced technician. The reproducibility and accuracy of the results of computer-aided sperm morphometric assessment (CASMA) can, however, be compromised by methodological inconsistencies, such as focus, illumination, sample preparation and staining (323, 324), and by technical difficulties in correctly differentiating sperm heads from seminal debris, particularly when sperm concentration is low (322, 324-326). The nature of automated evaluation means that there is no way to compensate for preparation defects and artefacts. Thus, small differences in background shading relative to cell staining can result in incorrect classification or an inability to identify the cell as a spermatozoon, with a consequent bias in the results.

As with manual morphology assessment, procedures and instruments must be standardized and QC maintained to ensure comparable and reliable results. Semen may be treated as described in the section on **Debris-laden or viscous ejaculates on page 45** to reduce background for CASMA recordings. If the sperm concentration is low ( $< 2 \times 10^6/\text{ml}$ ), samples will need to be concentrated by centrifugation, as described in the section on **Ejaculates with low sperm concentration on page 45**. However, it should be noted that centrifugation may affect sperm morphology, and its use must be recorded.

Two studies have reported significant relationships between CASMA results and fertility end-points. Coetzee et al. (327) found automated normal sperm morphology outcomes to be significant predictors of both fertilization rates in vitro and pregnancy. Garrett et al. (102) found that the percentage of spermatozoa in semen that exhibited head morphology characteristic of those that are bound to the zona pellucida ("zona-preferred", %Z) together with straight-line velocity (VSL) in semen were significantly and independently related to natural pregnancy rates in a large group of subfertile couples. The relationships of both %Z and VSL with fertility appeared to be continuous, and no threshold value was identified above which there was no further increase in pregnancy rate. More studies of fertility outcomes, as well as male reproductive organ function and disorders, in large populations are required to refine the application of CASA to measuring sperm morphology.

Automated systems may be useful for obtaining additional research data (including on morphological subpopulations of spermatozoa, plasma membrane integrity, sperm energy index) (328-330) and for QC systems, but more research is needed to show their benefits for clinical purposes.

Lack of IQC can lead to a large number of CASA errors between systems and laboratories. Therefore, it is necessary to standardize the process and QC for CASA (331). Despite the emerging results of comparative studies (332-337), there is still not enough evidence that would allow the use of computer analysis CASA in wide clinical practice.

## 4.6 Emerging technologies

In recent years, many emerging technologies have been developing that are potentially capable of significantly increasing the efficiency and insight of computer analysis in the near future. These technologies can be classified as either computational (algorithmic developments) or technological (incorporating new devices or functional tests).

### 4.6.1 Computational advances

Advances in image-processing algorithms are enabling the analysis of sperm in greater numbers and more detail than has been previously possible. New systems have been shown to be able to extract the tracks of individual cells in samples at much higher concentration of cells than traditional CASA, as shown in Fig. 4.5a (338, 339). The use of CASA kinematic measurements to classify sperm into different subpopulations is being shown to improve understanding and monitoring of changes in cell motility (320).

Moving beyond head-derived measures of motility, it is now possible to automatically track the flagellar waveform of swimming cells (see **Fig. 4.5b on page 160**) (316). While more care is required when imaging cells to ensure that the beating flagellum is visible and in focus, flagellar tracking can enable an abundant array of diagnostic, toxicological and therapeutic possibilities in human sperm research. Visualization of the flagellar beat in fluid of known viscosity also allows an assessment of energy expended by the cell, or variance of this in the population.

In addition to commercial CASA systems, several freely available or open-source offerings have been developed to increase access to computer-aided analyses (316, 340).



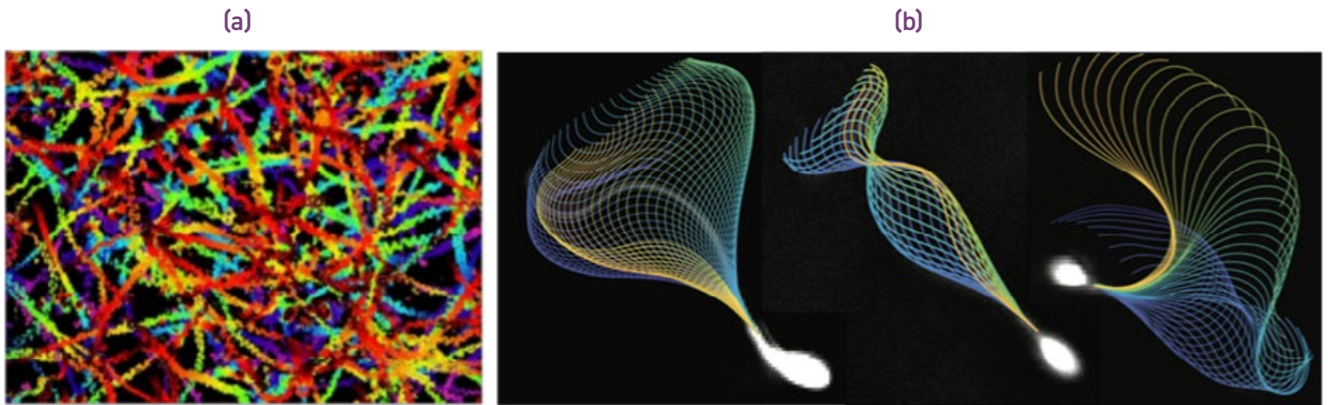
**Comment:** Care should be taken when employing emerging technologies that have not been certified for clinical use, but their use to further investigate questions in research is to be encouraged.

### 4.6.2 Technological advances

Increasingly, the development of CASA and other emerging computational advances is being supplemented by the use of additional technologies to improve quality and access to diagnostics.

Existing CASA systems, usually designed for laboratory use, are often expensive and inaccessible. The use of smartphones may have great potential for sperm analysis because they are mobile, equipped with high-quality digital cameras and can be easily attached to a microscope (341). Currently smartphone-based devices cannot achieve the quality and accuracy needed for a full semen analysis, however the widespread use of such devices could become useful as a means for men to seek early proper medical advice, investigation and causal treatment. Care should be taken when employing emerging technologies that have not been certified for clinical use, but their use to further investigate questions in research is to be encouraged.

**Fig. 4.5 Examples of graphical expressions of different CASA applications**



a) Typical colour-coded image of a densely concentrated sample for 10 seconds under a 10× objective lens (each trajectory represents a motile sperm) (339); b) The flagellar waveform of a sperm (left to right): in low-viscosity media, in high-viscosity media and hyperactivated (316)



# Chapter 5: Sperm preparation techniques

5.1 Introduction .....	161
5.2 General principles.....	163
5.3 Simple washing.....	164
5.4 Direct swim-up.....	165
5.5 Discontinuous density gradients.....	166
5.6 Magnetic activating cell sorting (macs).....	166
5.7 Preparing HIV-infected semen samples .....	167
5.8 Preparing testicular and epididymal spermatozoa .....	167
5.9 Preparing retrograde ejaculation samples.....	169
5.10 Preparing assisted ejaculation samples .....	170

## 5.1 Introduction

### 5.1.1 Rationale

Spermatozoa may need to be separated from seminal plasma for a variety of purposes, such as diagnostic and research tests for functional competency, evaluation of effects of media composition, and sperm recovery for assisted reproductive technologies (ART). The premise on which sperm preparation techniques are considered for ART is ensuring good sperm quality and elimination of factors that are detrimental to fertilization. If tests of sperm function are to be performed, it is critical that the spermatozoa are separated from the seminal plasma within 1 hour of ejaculation, to limit any damage from non-sperm cells (284) and to reduce detrimental effects of increasing osmolality occurring in ejaculates kept in vitro (147, 342).

“

An ideal sperm preparation technique should recover a highly functional sperm population that preserves DNA and does not induce dysfunction through the production of ROS by sperm and leukocytes.

”



Although some components of the mixed seminal plasma appear to help spermatozoa penetrate cervical mucus when compared to, for example, **Tyrode's** solution (Overstreet et al., 1980), the negative impact of seminal vesicular fluid on sperm motility, survival and protection of the sperm DNA is well documented (13, 256), as is the presence of "decapacitating factors" in seminal plasma (343). Furthermore, some components of seminal plasma are obstacles to the achievement of pregnancy when natural barriers are bypassed in ART, such as IUI or IVF. The separation of human spermatozoa from seminal plasma and processing to yield a final preparation containing a high percentage of morphologically normal and motile cells, with reduced DNA damage, free of debris, non-germ cells and dead spermatozoa, is important for clinical practice and research prognostic thresholds.

### 5.1.1.1 Choice of method

The choice of sperm preparation technique is dictated by the nature of the semen sample (344, 345) and its purpose. For assisted reproduction, including IVF procedures, sperm preparation techniques need to yield a sperm population with minimal DNA damage (346). An ideal sperm preparation technique should recover a highly functional sperm population (347) that preserves DNA and does not induce dysfunction through the production of ROS by sperm and leukocytes (348, 349). Recovered sperm should have suitable morphology and retain functional motility for the range of ART being considered. Diluting semen with culture media and centrifuging has been suggested for preparing normozoospermic specimens for IUI (345, 350), while consideration of method choice is also dictated by indication or purpose of use. For example, the direct swim-up technique is useful in selecting motile sperm, as it reflects the motile capacity of sperm to swim into the culture medium. Studies have shown that DNA fragmentation, characterized by the presence of single- or double-strand DNA damage, is negatively correlated with ART outcomes (346, 351, 352) (**Section 3.2 on page 86**). Both direct swim-up and pellet swim-up techniques significantly decreased the total rate of DNA fragmentation, although pellet swim-up involves centrifugation, which could affect other sperm functional parameters (353, 354). The direct swim-up technique is often used when semen samples are considered to be largely normal, whereas in cases of severe oligozoospermia, teratozoospermia or asthenozoospermia, DGC is usually preferred because of the greater yield and therefore likely total number of motile spermatozoa recovered. Density gradients can also be altered to optimize handling of specific properties of individual samples: the total volume of gradient material can be reduced, limiting the distance that the spermatozoa sediment and maximizing total motile sperm recovery, or the centrifugation time can be increased for specimens with high viscosity.

Each laboratory should determine the centrifugal force and centrifugation time necessary to form a manageable sperm pellet. When sperm numbers are extremely low, it may be necessary to modify the centrifugal force or the time, to increase the chances of recovering the maximum number of spermatozoa. Modifications to recommended times and centrifugal forces should be rigorously tested prior to clinical implementation. The most suitable method of preparation can be identified from the functional capacity of the prepared spermatozoa, as determined, for example, by sperm motility (**Section 2.4.6 on page 23**) and vitality (**Section 2.4.7 on page 26**).





### 5.1.1.2 Efficiency of sperm separation from seminal plasma and handling of infectious organisms

The efficiency of a sperm selection technique is usually expressed as the absolute sperm number, the total number of motile spermatozoa or the recovery of morphologically normal motile spermatozoa. Swim-up generally produces a lower recovery of motile spermatozoa (< 20%) than DGC (> 20%). Swim-up and DGC also produce different levels of contamination with seminal components in the final sperm preparation. Using the prostatic secretion zinc as a marker of soluble seminal components, a time-dependent diffusion of zinc from semen into the overlaying swim-up medium has been demonstrated (355). The final zinc concentration in swim-up preparations was greater than that after density-gradient preparation.

Semen samples may contain harmful infectious agents, and technicians should handle them as a biohazard with extreme care. Beside eliminating low-quality sperm, including those immotile, sperm preparation should allow elimination of other cells, such as leukocytes, and bacteria, (356), as well as toxic or bioactive substances (347). Sperm preparation techniques cannot be considered 100% effective in removing infectious agents from semen (Section 5.7 on page 167). Safety guidelines, as outlined in Section 8.2 on page 214, should be strictly observed. Good laboratory practice is fundamental to laboratory safety (48, 357).

## 5.2 General principles

Some of the available sperm preparation techniques are described in the following sections. For all of them, the culture medium suggested is a balanced salt solution supplemented with protein and containing a buffer appropriate for the environmental conditions in which the spermatozoa will be processed. For assisted reproduction procedures, such as ICSI, IVF and artificial insemination, it is imperative that the human serum albumin is highly purified and free from viral, bacterial and prior contamination. Albumin specifically designed for such procedures is commercially available. For diagnostic purposes much less expensive BSA can be used (Section 8.4 on page 225). If the incubator contains only atmospheric air and the temperature is 37 °C, the medium should be buffered (see Section 8.4.1 on page 225). Adherence to this will ensure that the culture pH is compatible with sperm survival. The final disposition of the processed spermatozoa will determine which buffered medium is appropriate. For example, sperm function assays in general will require a medium that supports sperm capacitation, which typically contains sodium bicarbonate (25 mmol/L).

Semen for ART should be collected in a sterile manner (Section 2.5.12 on page 68). Sterile techniques and materials are essential when applying a sperm preparation technique for therapeutic applications.



**Note:** Although media can be prepared in the laboratory, it should be noted that the performance of the solution and its safety cannot be precisely controlled. It is usually expected that, where available, media commercially manufactured, tested and approved for therapeutic use are used in ART.

Examples of media which can be prepared or purchased are provided below, but this is not a recommendation for their therapeutic use in ART.



## 5.3 Simple washing

This simple washing procedure provides a high yield of spermatozoa if semen samples are of good quality, but it does not eliminate debris or leukocytes that are present in semen.

### 5.3.1 Reagents

- **BWW, EBSS, sEBSS, HTF** (commercially available or see **Section 8.4 on page 225**) or other proprietary and appropriately tested and manufactured media, supplemented preferably with human serum albumin (HSA), or serum, as described below
- HSA, highly purified and free from viral, bacterial and prion contamination and endotoxins
- HSA supplement: to 50 ml of medium add 300 mg of HSA, 1.5 mg of sodium pyruvate, 0.18 ml of sodium lactate (60% (v/v) syrup) and 100 mg of sodium bicarbonate
- Serum supplement if required (e.g. to the non-proprietary media described): to 46 ml of medium add 4 ml of heat-inactivated (56 °C for 20 minutes) patient's serum, 1.5 mg of sodium pyruvate, 0.18 ml of sodium lactate (60% (v/v) syrup) and 100 mg of sodium bicarbonate.

### 5.3.2 Procedure

1. Mix the semen sample well.
2. Dilute the entire semen sample 1+1 (1 : 2) with medium to promote removal of seminal plasma.
3. Transfer the diluted suspension into multiple centrifuge tubes, with preferably not more than 3 ml per tube.
4. Centrifuge at 300–500g for 5–10 minutes.
5. Carefully aspirate and discard the supernatants.
6. Resuspend the combined sperm pellets in 1 ml of medium by gentle pipetting.
7. Centrifuge again at 300–500g for 3–5 minutes.
8. Carefully aspirate and discard the supernatant.
9. Resuspend the sperm pellet, by gentle pipetting, in a volume of medium appropriate for final disposition, e.g. insemination.

The number of washings to remove seminal plasma can be reduced by using fewer tubes and increasing the volume in each tube. If this is done, the centrifugal force and duration of centrifugation should be increased, to ensure complete pelleting of spermatozoa, e.g. 500–600g for 8–10 minutes. Note that centrifugation force varies with radius and number of revolutions per minute (rpm) (see **Section 8.2.2 on page 217** for calculation of centrifugal forces).



## 5.4 Direct swim-up

Spermatozoa may be selected by their ability to swim out of seminal plasma and into culture medium. This is known as the “swim-up” technique. The semen should preferably not be diluted and centrifuged prior to swim-up, because this can result in peroxidative damage to the sperm membranes (348). Thus, a direct swim-up of spermatozoa from semen is the preferred method for separating out motile spermatozoa (e.g. 45, 46). The direct swim-up technique can be performed either by layering culture medium over the liquefied semen or by layering liquefied semen under the culture medium. Motile spermatozoa then swim into the culture medium. This procedure gives a lower yield of spermatozoa than washing but selects them for their motility and is useful where the percentage of motile spermatozoa in semen is low, e.g. for IVF and ICSI.

### 5.4.1 Reagents

- **BWW, EBSS or sEBSS (Section 8.4 on page 225)** supplemented preferably with HSA, or serum, as described below
- HSA, highly purified and free from viral, bacterial and prion contamination and endotoxins
- HSA supplement: to 50 ml of medium add 300 mg of HSA, 1.5 mg of sodium pyruvate, 0.18 ml of sodium lactate (60% (v/v) syrup) and 100 mg of sodium bicarbonate
- Serum supplement: to 46 ml of medium add 4 ml of heat-inactivated (56 °C for 20 minutes) patient’s serum, 1.5 mg of sodium pyruvate, 0.18 ml of sodium lactate (60% (v/v) syrup) and 100 mg of sodium bicarbonate.

### 5.4.2 Procedure

1. Mix the semen sample well.
2. Place 1 ml of semen in a sterile 15-ml conical centrifuge tube, and gently layer 1.2 ml of medium over it. Alternatively, pipette the semen carefully under the culture medium.
3. Incline the tube at an angle of about 45°, to increase the surface area of the semen–culture medium interface and incubate for 1 hour at 37 °C.
4. Gently return the tube to the upright position and remove the uppermost 1 ml of medium. This will contain highly motile sperm cells.
5. Dilute this with 1.5–2.0 ml of medium.
6. Centrifuge at 300–500g for 5 minutes and discard the supernatant.
7. Resuspend the sperm pellet in 0.5 ml of medium for assessment of sperm concentration, total motility and progressive motility (**Section 2.4.6 on page 23** and **Section 2.4.8 on page 28**).
8. The specimen may be used directly for therapeutic or research purposes.



## 5.5 Discontinuous density gradients

Discontinuous density gradients can be used as an effective and adaptable method to collect high-quality sperm for ART. It can provide a good selection of motile sperm, free from other cell types and debris. It is easier to standardize than the swim-up technique, and thus results are more consistent. This technique is used to recover and prepare spermatozoa for use in IVF and ICSI.

This method uses centrifugation of semen over density gradients consisting of colloidal silica coated with silane, which separates cells by their density alone. A simple two-step discontinuous density-gradient preparation method is most widely applied. Manufacturers' guidance should be followed (*see 84*). Sperm preparation using density-gradient centrifugation (DGC) usually results in a fraction of highly motile spermatozoa, free from debris, contaminating leukocytes, non-germ cells and degenerating germ cells.

A number of commercial products are available for making density gradients suitable for semen processing. Any departure from procedural recommendations should be evidence-based. Most density-gradient media contain high relative molecular mass components that have inherently low osmolality, so they are usually prepared in a medium that is iso-osmotic with female reproductive tract fluids.

### 5.5.1 Reagents and procedure

Prepare and use as per manufacturers' instructions, as discussed above. Care should be taken if large volumes of gradient are prepared, as it is susceptible to contamination by microorganisms. If any are observed on a microscope, it must be discarded.

## 5.6 Magnetic activating cell sorting (MACS)

The advent of ART, in particular where the requirement is to retrieve sperm for assisted conception, such as ICSI in the case of male factor infertility, has led to the development of additional assays for optimized functional sperm recovery, free from significant DNA damage.

A Cochrane systematic review (*358*) did not see differences in clinical or live birth between MACS and sperm selected by hyaluronic acid binding (HA-ICSI) or other selection techniques, on live birth. In addition, increased DNA fragmentation has been observed following DGC, resulting in lower probability of pregnancy among IVF/ICSI couples (*354*).

### 5.6.1 Reagents and equipment for sperm recovery through MACS

- HTF-modified HEPES buffer
- Annexin V-conjugated microspheres or microbeads
- Annexin V microbead kit (Miltenyi Biotec, Huburn, CA, USA; MACS Good Manufacturing Practice (GMP) Annexin V kit, Miltenyi Biotec, Germany)



- Separation column or iron-globe fitted magnet (Mini MACS, Miltenyi Biotec)
- Eppendorf tubes (1.5 ml)
- Centrifuge
- Incubator.

### 5.6.2 Procedure

1. 0.5ml aliquot of sperm is suspended in **HTF**-modified **HEPES** buffer, obtained after sperm wash to remove seminal plasma, or before DGC, when procedure is added.
2. Centrifuge and suspend pellet in 80 µl of binding buffer, with 20 µl of Annexin V-conjugated microspheres (Annexin V microbead kit, Miltenyi Biotec, Huburn, CA, USA), for 15 minutes at room temperature.
3. Add 400 µl of binding solution and place in separation column and non-labelled (viable) cells passed through the column.
4. Non-labelled fraction is recovered and processed as described (359).

## 5.7 Preparing HIV-infected semen samples

If the human immunodeficiency virus (HIV) is present in semen, viral ribonucleic acid (RNA) and proviral DNA can be found free in seminal plasma and in non-sperm cells. In a systematic review and meta-analysis (360) involving 11 585 cycles of ART with use of washed sperm among 3994 women from HIV-discordant couples, 56.3% achieved clinical pregnancy, and no HIV seroconversion occurred without plasma viral suppression. As HIV receptors (CD4, CCR5, CXCR4) are expressed only by non-sperm cells, a combination of DGC followed by swim-up has been proposed as a way of preventing infection of uninfected female partners (361, 362), but other validated methods also exist (363). These procedures were developed to separate virus-infected non-sperm cells and seminal plasma (in the density-gradient supernatant) from HIV-free, motile spermatozoa in the swim-up (from the density-gradient pellet). Prepared samples should be tested by reverse transcription polymerase chain reaction (RT-PCR) before use, and only HIV-free samples used for ART. While results so far are encouraging, there is as yet insufficient evidence of the elimination of risk of HIV infection through sperm preparation.



**Note:** This technique should be used only in secure facilities, to minimize the risk of cross-contamination of HIV-free samples (364). Recent evidence (365-368) showed that in discordant couples, where viral suppression is achieved, there is little or no transmission of HIV to the partner.

## 5.8 Preparing testicular and epididymal spermatozoa

Spermatozoa recovered from testicular tissue and the epididymis require special preparation. The typical indication for epididymal aspiration is obstructive azoospermia rather than testicular dysfunction. Consequently, relatively large numbers of spermatozoa can be harvested for therapeutic purposes. Epididymal

aspirates can often be obtained with minimal red blood cell and non-germ cell contamination, making the isolation and selection of motile epididymal spermatozoa relatively straightforward. If large numbers of epididymal spermatozoa are obtained, DGC is an effective method of preparing them for subsequent use (**Section 5.4 on page 165**). If sperm numbers are low, a simple wash can be performed (**Section 5.3 on page 164**).

Testicular spermatozoa can be retrieved by open biopsy (with or without microdissection) or by percutaneous needle biopsy. Testicular specimens are invariably contaminated with non-germ cells and large numbers of red blood cells, so additional steps are needed to isolate a clean preparation of spermatozoa. To free the seminiferous tubule-bound elongated spermatids (“testicular spermatozoa”), enzymatic or mechanical methods are needed. Testicular spermatozoa are prepared for ICSI, since sperm numbers are low and their motility is poor.

### 5.8.1 Enzymatic method

1. Incubate the testicular tissue with collagenase (e.g. 0.8 mg of *Clostridium histolyticum*, type 1A per ml of medium) for 1.5–2 hours at 37 °C, vortexing every 30 minutes.



**Note:** enzymes may cause damage to the sperm and, if used, should be suitable for therapeutic use.

2. Centrifuge at 100g for 10 minutes and examine the pellet.

### 5.8.2 Mechanical method

1. Macerate the testicular tissue in culture medium with glass coverslips until a fine slurry of dissociated tissue is produced.
2. Alternatively, strip the cells from the seminiferous tubules using fine needles (attached to disposable tuberculin syringes) bent parallel to the base of the culture dish.

### 5.8.3 Processing sperm suspensions for intracytoplasmic sperm injection

1. Wash the specimens obtained by adding 1.5 ml of culture medium.
2. Centrifuge at 300g for 8–10 minutes.
3. Remove the supernatant and resuspend the pellet in 0.5 ml of fresh culture medium.
4. Estimate the motility and number of spermatozoa in the pellet. (Some specimens with a low number of spermatozoa may need to be resuspended in a lower volume of medium.)
5. Place a 5–10- $\mu$ l droplet of culture medium in a culture dish.
6. Cover it with mineral oil (pre-equilibrated with CO<sub>2</sub>).



7. Introduce 5–10 µl of the sperm suspension into the culture medium.
8. Carefully aspirate the motile spermatozoa found at the interface between the culture medium and oil with an ICSI pipette.
9. Transfer them to a droplet of viscous solution, e.g. polyvinylpyrrolidone (7–10% (100 g/L) in medium).

## 5.9 Preparing retrograde ejaculation samples

In some men, semen passes into the bladder at ejaculation, resulting in aspermia – no apparent ejaculate. Confirmation of this situation is obtained by examining a sample of post-orgasmic urine for the presence of spermatozoa. If pharmacological treatment is not possible or not successful, spermatozoa may be retrieved from the urine. Alkalinization of the urine by ingestion of sodium bicarbonate, for example, will increase the chance that any spermatozoa passing into the urine will retain their motility characteristics (369).

### 5.9.1 No alkalinization treatment given prior to sperm collection

At the laboratory the man should be asked to:

- urinate without completely emptying the bladder;
- produce an ejaculate by masturbation into a specimen container; and
- urinate again into a second specimen vessel containing culture medium (to alkalinize the urine further).

### 5.9.2 Alkalinization treatment given prior to sperm collection

Alkalinization of the urine can be achieved by drinking water with sodium chloride and sodium bicarbonate 1–2 hours before attempt to collect an ejaculate. This can be combined with alpha-1-receptor stimulator treatment.

At the laboratory the man should be asked to:

- produce an ejaculate by masturbation into a specimen container; and
- urinate after orgasm in a second container (volume at least 500 ml)

### 5.9.3 Analysis of antegrade ejaculates and post-orgasmic urine

Both the ejaculate, if any, and urine samples should be analysed. Because a large volume of urine may be produced, it is often necessary to concentrate the specimen by centrifugation (500g for 8 minutes) The retrograde specimen, once concentrated, and the antegrade specimen, if produced, can be most effectively processed using the density-gradient preparation method (**Section 5.5 on page 166**).



## 5.10 Preparing assisted ejaculation samples

Semen from men with disturbed ejaculation, or who cannot ejaculate, may be collected by direct vibratory stimulation of the penis or rectal electrical stimulation of the accessory organs. Ejaculates from patients with spinal cord injury will frequently have high sperm concentrations, decreased sperm motility, and red and white blood cell contamination. Specimens obtained by electro-ejaculation can be processed most effectively by DGC (**Section 5.5 on page 166**). Regardless of the method of preparation, these types of ejaculates will often contain a high percentage of immotile sperm cells.







# Chapter 6: Cryopreservation of spermatozoa

6.1 Introduction .....	171
6.2 Reasons for cryopreservation of spermatozoa .....	172
6.3 Risk assessment of cryopreservation and storage of human semen.....	174
6.4 Semen cryopreservation protocols .....	177
6.5 Vitrification .....	182

## 6.1 Introduction

Cryopreservation of spermatozoa is an important part of the work of many semen analysis laboratories, particularly those associated with infertility clinics.

The history of human sperm cryobiology dates from the late 1940s. The discovery that glycerol protected spermatozoa against damage from freezing led to the use of human spermatozoa stored on dry ice at  $-79\text{ }^{\circ}\text{C}$  (370-372). Subsequently, liquid nitrogen was used, and semen cryopreservation developed rapidly in many countries with the establishment of commercial sperm banks or coordinated national services (373-377).

“

Cell survival after freezing and thawing depends largely on minimization of intracellular ice crystal formation.

”

A variety of cryopreservation protocols are now used with different cryoprotectants and freezing procedures. Cell survival after freezing and thawing depends largely on minimization of intracellular ice crystal formation. This is done by using appropriate cryoprotectants and applying rates of cooling and warming that minimize the amount of intracellular water subject to ice formation (378-380). If the spermatozoa spend significant periods of time above  $-130\text{ }^{\circ}\text{C}$  (the glassy transition temperature), particularly during the thawing process, recrystallization can occur, with growth of potentially damaging intracellular ice crystals. There are two categories of cryoprotectants: permeable, such as dimethyl sulfoxide (DMSO) and glycerol, and impermeable, such as albumins, dextrans and egg yolk citrate.

Human spermatozoa tolerate a range of cooling and warming rates. They are not very sensitive to damage caused by rapid initial cooling (cold shock), possibly because of high membrane fluidity from the unsaturated fatty acids in the lipid

bilayer (381). They may also be more resistant than other cells to cryopreservation damage because of their low water content (about 50%). However, cryopreservation does have an adverse effect on human sperm function, particularly motility. After cryopreservation, the percentage of motile spermatozoa may decrease from 50.6% to 30.3%, depending on the studies (382). Optimizing the cryopreservation process will likely minimize this damage.

Pregnancy rates after artificial insemination with cryopreserved donor semen are often related to sperm quality after thawing, timing of insemination and, particularly, recipient factors, such as age, previous pregnancy with donor insemination, and ovulatory and uterine tubal disorders (383). If semen is stored under appropriate conditions, there is no obvious deterioration in sperm quality with time; children have been born following fertilization using semen stored for over 28 years (384, 385). In selected cases (for instance, when high levels of leukocytes are present in semen), selection of highly motile fractions of spermatozoa (**Chapter 5 on page 161**) is advised, as it can give better recovery (386).

## 6.2 Reasons for cryopreservation of spermatozoa

Two broad areas of human semen cryobanking can be identified: for one's own future use (autologous ART) and donor banking (homologous ART).

Spermatozoa may be stored for one's future use for a variety of reasons according to national guidelines (371). In particular, according to the American Society of Clinical Oncology, health-care providers should always offer sperm cryopreservation to all post-pubertal males in reproductive age receiving cancer treatment, as it is the only effective treatment for these patients (387). Men should also be advised of a potential higher risk of genetic damage in sperm collected after initiation of chemo- or radiotherapies, and sperm banking should occur before. In some cases, the cryopreservation procedure may need to be modified (Section 6.2.2).

Current data do not find any important difference in using cryopreserved or fresh sperm during ART (388-390), but it is worth mentioning that there are data reporting increased DNA fragmentation after cryopreservation (391).

### 6.2.1 Donor sperm

Ejaculates from healthy donors known or presumed to be fertile may be stored for future use. In many countries donor sperm must be quarantined for 6 months to enable testing of the donor for sexually transmitted infections, to ascertain that the donated ejaculates do not contain microorganisms such as HIV. Donors may be recruited by a clinic or sperm bank, and their spermatozoa used anonymously or not according to national guidelines and legislations. Donor spermatozoa can be used for artificial insemination, IUI, IVF or ICSI, e.g.:

- for the partner of an infertile man with no live spermatozoa or elongated spermatids suitable for ICSI, or where treatment has failed or is too costly;
- to prevent transmission of an inherited disorder;



- after recurrent miscarriage, where insemination with donor spermatozoa may result in a successful pregnancy;
- for women who wish to conceive but do not have a male partner; in those countries where it is allowed.

Local and national legislation regarding genetic and infection screening should always be complied with.

### 6.2.2 Fertility preservation

Ejaculates may be obtained and stored before a man undergoes a procedure or exposure that might impair his fertility, such as:

- vasectomy (in case of a future change in partner situation or desire for more children);
- treatment with cytotoxic agents or radiotherapy, which is likely to impair spermatogenesis permanently (387);
- active duty in a dangerous occupation, e.g. in military forces, in countries where posthumous procreation is acceptable or genital injury may occur;
- male-to-female transgender adults and adolescents (392);
- testicular trauma (in some circumstances after testicular sperm extraction, TESE) (393).



**Note 1:** For fertility preservation or infertility treatment, ideally enough normal specimens should be stored for 10 or more inseminations, to ensure a good chance of pregnancy.



**Note 2:** As only a single spermatozoon is needed for ICSI of each oocyte, cryopreservation of any live spermatozoa is worthwhile.



**Note 3:** Storage of semen collected before a potentially sterilizing procedure often has significant psychological value, because it gives the hope of future paternity. For patients about to undergo therapy with alkylating agents or radiotherapy, the semen must be collected before the therapy starts, because of the risk of mutagenesis in the spermatozoa. All patients requiring chemo- or radiotherapy, including adolescents (394), should be offered the possibility of storage of spermatozoa.

### 6.2.3 Infertility treatment

Spermatozoa may be stored for treatment using the individual's sperm in IUI, IVF or ICSI, e.g. in cases of:

- severe oligozoospermia or intermittent presence of motile spermatozoa in the semen (as backup for ICSI) (395), or Klinefelter subjects (at puberty) when a semen sample can be collected (396);
- infertility treatment that may not persist, such as surgery for genital tract obstruction or gonadotrophin treatment for hypothalamic-pituitary hypogonadism;

- the need for special collection, such as assisted ejaculation for patients with spinal cord injury, spermatozoa from retrograde ejaculation in urine, or surgical collection from the genital tract;
- patients who are unable to provide fresh semen on the day of an ART procedure such as:
  - men who cannot be present in the ART laboratory on the day of insemination or who have difficulties collecting semen for psychological reasons;
  - men with non-obstructive azoospermia requiring testicular sperm extraction;\*
  - men with spinal cord injury requiring testicular sperm extraction;\*
  - men undergoing vasovasostomy or vasoepididymostomy for obstructive azoospermia with microsurgical epididymal aspiration or testicular sperm extraction for fertility preservation.\*

\* In these cases, the procedure described in **Section 6.4.2 on page 180** should be followed.

Concern has also been raised that in couples with a severe male factor, ART with the partner's sperm can be much less successful than ART with donor sperm (397).

#### 6.2.4 Minimizing infectious disease transmission

For men with HIV controlled by antiretroviral therapy, samples with an undetectable viral load may be stored for IUI, IVF or ICSI, to attempt conception while reducing the risk of transmission of HIV to the female partner. Similarly, for men who want to cryopreserve sperm while seropositive for Hepatitis B or C, for instance, viral load should be checked.

### 6.3 Risk assessment of cryopreservation and storage of human semen

The cryopreservation and subsequent storage of human spermatozoa is a highly complex process, which places a special responsibility and potential liability on the laboratory staff. In assessing the risks associated with cryopreservation and storage of semen, the following issues should be considered.

#### 6.3.1 Resources

- Physical security of the vessels, specimens and storage room, to reduce risk of loss by theft or fire, failure of cryopreservation straws, ampoules and vessels, liquid nitrogen supply
- Suitability of equipment for proposed use
- System of containment and removal of nitrogen

- Tanks should be alarmed for level of nitrogen below a certain threshold or temperature above a certain threshold. The alarm level should be set such that it provides warning before a critical situation occurs, and it should be connected to a call centre which will then advise sperm bank personnel.

### 6.3.2 Staff safety and protection

- Personal protective equipment should always be available in the bank. If possible, two persons should be concomitantly present in the bank; otherwise the external personnel should be alerted before entering.
- Alarm systems for detection of low atmospheric oxygen levels and corrective actions associated with these are advised.

### 6.3.3 Risk of cross-contamination

To reduce the risk of cross-contamination with infectious agents between samples in storage (e.g. transmission of HIV, or hepatitis B (HBV) or C (HCV) virus via a cryopreservation vessel), consider:

- type of storage containment: vials or straws and method of sealing straws (heat or polymer) and the use of a secondary sleeve (straw-in-straw);
- nature of storage vessel: liquid nitrogen or vapour;
- protocol and method of storage of high-risk samples (samples known to contain or suspected of containing viruses). In these cases, use of separate tanks for each virus positivity is recommended and, in some areas, required;
- perform cryopreservation of each patient separately and sanitize all the surface at the end of each procedure.

Other precautions that can be taken to avoid or limit contamination if precautions above cannot be secured:

- sterilization of liquid nitrogen to prevent contamination – useful in case of vitrification where the sample is directly immersed in liquid nitrogen (398);
- periodic refilling of Dewar storage flasks or tanks with sterile liquid nitrogen and annual decontamination of the cryotanks;
- decontamination of frozen specimens before warming;
- perform the tests for viruses and sexually transmitted infections on all males at the time of banking as follows (or according to national regulations):
  - HIV, types 1 and 2 (using nucleic acid testing (NAT), which also tests for group O antibodies);
  - HBV test for Hepatitis B surface antigen (HBsAg), total antibody to Hepatitis B core antigen (anti-HBc) (IgG and IgM) and a NAT assay for HBV or combination that includes HBV;

- HCV using anti-HCV and a NAT assay for HCV;
- *treponema pallidum* (i.e. syphilis);
- *chlamydia trachomatis* (using test design for detecting in asymptomatic, low-prevalence populations);
- *neisseria gonorrhoea* (using test design for detecting in asymptomatic, low-prevalence populations);
- human T-lymphotropic virus (HTLV), types I and II using anti-HTLV I/II;
- cytomegalovirus (CMV) using anti-CMV (total and IgG and IgM).



**Note:** For sperm donors, other tests may be required according to national legislation.

### 6.3.4 Security of frozen samples

- Split samples and store in separate cryovessels and/or at different sites to reduce risk of total loss.
- Double-check identity of samples at each step.
- Use robust labelling and identifying codes.
- Have procedures for regular audit of use of material and samples remaining in storage.
- After prolonged use, cryostorage tanks can become contaminated. They should therefore be periodically decontaminated with solutions that do not react with aluminium or steel. Decontamination at least once a year is suggested.
- All the tanks should contain low-level sensor alarms to monitor temperature and liquid nitrogen level. The sensors should be connected to an alarm to alert laboratory personnel of eventual problems.

Sources: (364, 377, 399, 400).



**Note 1:** Storage in the vapour phase rather than in the liquid nitrogen itself may reduce the risk of cross-contamination. However, large temperature gradients can exist in vapour storage vessels, depending on the shape, sample load and type of sample containers. If vapour phase storage is used, ensure that this is in a vessel designed for that purpose and ratified to international medical device standards.



**Note 2:** Secure straws made from heat-sealable ionomeric resin are available for storage in liquid nitrogen (high-security straws). These are leak-, bacteria- and virus-proof, and mechanically resistant at  $-196\text{ }^{\circ}\text{C}$  (364, 377, 400).

## 6.4 Semen cryopreservation protocols

Several freezing and sperm bank management protocols are available (377). Several cryoprotectants are available commercially. Cryoprotectants are classified as permeating (among which, glycerol is the most widely used) and penetrating or non-permeating (such as sugar molecules and egg yolk). Cryoprotectants containing or not containing egg yolk (as semen extenders) can both be used (377). Details of a commonly used cryoprotectant – glycerol-egg yolk-citrate (GEYC) – and machine-controlled or vapour freezing procedures are given below.

Considering that the cryopreserved spermatozoa may be used to generate embryos, all the procedures should, if possible, be performed under a class A hood in a classified room (at least D) according to international good manufacturing practice guidelines. The methods and environment of freezing should be documented if below this standard, but if legal, they are not a reason to refuse performing storage.

### 6.4.1 Standard procedure

#### 6.4.1.1 Preparing the GEYC cryoprotectant



**Note:** Although cryoprotectants can be prepared in the laboratory, it should be noted that the performance of the solution and its safety cannot be precisely controlled. **It is usually expected that, when available, cryoprotectants commercially manufactured, certified and approved for therapeutic use are used.** This is particularly an issue for egg yolk-based cryoprotectants, as contaminants from chicken feed or the environment could be present. The procedures described below are very difficult to standardize to a suitable level for ART therapeutic use in local laboratories.

Preparing the GEYC:

1. To 65 ml of sterile purified water add 1.5 g of glucose and 1.3 g of sodium citrate tribasic dihydrate.
2. Add 15 ml of glycerol and mix thoroughly.
3. Add 1.3 g of glycine. When dissolved, filter the solution through a 0.45- $\mu$ m pore filter.
4. Add 20 ml of fresh egg yolk (preferably obtained from specific pathogen-free eggs), wash the egg and remove the shell. Pierce the membrane surrounding the yolk and take up into a syringe (approximately 10 ml of yolk will be obtained per egg).
5. Place the whole suspension in a water bath at 56 °C for 40 minutes and swirl occasionally.
6. Check the pH of the solution. If it is outside the range 6.8–7.2, discard the solution and prepare a new one, in case incorrect ingredients or amounts were added.
7. Bacterial culture for sterility testing can be performed at this stage.



8. Testing for sperm toxicity can be performed at this stage.

9. Dispense the solution in 2-ml aliquots in a sterile work cabinet and store at  $-70^{\circ}\text{C}$ .

10. Use within 3 months.

Cryoprotectants similar to GEYC are commercially available.

#### 6.4.1.2 Adding cryoprotectant to semen

1. Thaw the cryoprotectant, warm to room temperature and mix. Initial warming to  $37^{\circ}\text{C}$  may be beneficial.

2. High concentrations of glycerol are detrimental to spermatozoa. It is thus vital to take special care when adding and mixing the cryoprotectant with the semen.

3. Add one volume of GEYC cryoprotectant to two volumes of semen, either drop by drop with swirling, or by gentle pipetting up and down, or gradually in five additions with gentle mixing over approximately 10 minutes at room temperature.

4. After all the GEYC cryoprotectant has been added, incubate the mixture at  $30\text{--}35^{\circ}\text{C}$  for 5 minutes.

#### 6.4.1.3 Filling semen straws

1. Plastic 0.5-ml straws are popular because of their heat transfer properties and ease of storage. Plastic vials may be used for storing larger volumes.

2. Aspirate the semen-GEYC cryoprotectant mixture into 0.5-ml plastic semen straws or place in cryovials. Some commercial straws are provided with a disposable "filling tip" which avoids the end of the straw being directly contaminated by semen. Straws can be filled with a manifold on a vacuum device or an adaptor to fit over the end of the straw. They are filled until the liquid touches the cotton-wool plug, which will prevent the straw emptying when suction is removed.

#### 6.4.1.4 Sealing semen straws

1. Leave a 1-cm air space at the lower end by tapping the straw on the side of the container. If using a filling tip, this will automatically be the case.

2. Heat-seal the straws at both ends by using a heat sealer.

3. Wipe the outside of the container dry and then sterilize with 70% (v/v) alcohol or another microbial decontaminant.

4. Ensure that the straws are labelled with correct patient/donor details and that they are correctly sealed at both ends at or before this stage (**Section 6.4.3 on page 181**).



#### 6.4.1.5 Cooling and freezing the semen in programmable freezers

Programmable freezers are available that control the injection of liquid nitrogen vapour into the freezing chamber.

1. Place the straws or cryovials in a programmable freezer and follow the manufacturer's instructions to activate the programme.
2. A common programme is to cool the straws at 1.5 °C per minute from 20 °C to -6 °C and then at 6 °C per minute to -100 °C. This takes about 40 minutes. The machine will then hold the chamber at -100 °C for 30 minutes to allow for delays before the straws are transferred to liquid nitrogen.
3. Other, more complicated, procedures may be used, depending on experience in individual laboratories (401).

#### 6.4.1.6 Cooling and freezing the semen manually

Manual methods are less controllable and standardized than programmable freezers but can give adequate results. There are many alternatives to this procedure.

1. Place the straws in a refrigerator freezer (-20 °C) for 30 minutes, then on dry ice (-79 °C) for 30 minutes before placing in liquid nitrogen (-196 °C).
2. The straws may be moved from the -20 °C freezer into another freezer at -70 °C, or into a basket or goblet in a mixture of liquid nitrogen vapour and air in the neck of a small liquid nitrogen container at -80 °C to -100 °C for 10–15 minutes, before being placed in liquid nitrogen. They can also be placed on a rack 10–20 cm above liquid nitrogen in a large container and left for 1 hour to develop a temperature gradient above the liquid nitrogen.

#### 6.4.1.7 Fast vapour freezing

Manual fast vapour freezing can also give adequate results.

1. Place the straws in liquid nitrogen vapours at about 10 cm above the level of N<sub>2</sub> (-80 °C) for 8–10 minutes to allow initial slow freezing. To standardize the process, commercially available boxes with floating racks for straws or for cryovials, which maintain a fixed distance between straws and nitrogen, can be used.
2. Plunge the straws in liquid nitrogen immediately afterwards.

#### 6.4.1.8 Storage of frozen semen

1. Place the frozen straws in plastic storage tubes (e.g. mini-goblets, tubes on canes or straw cassettes) and insert them in larger storage goblets.
2. Store the goblets with the straws in liquid nitrogen vacuum (Dewar) flasks or tanks.

### 6.4.1.9 Transport of frozen semen

Frozen spermatozoa can be transported in commercially available dry shipper tanks cooled with liquid nitrogen. Depending on the size of the shipper, suitably low temperatures can be maintained for several days to several weeks, as the liquid nitrogen evaporates.



**Note:** Ensure that local, national and international regulations on shipping liquid nitrogen and human biological samples are complied with.

### 6.4.1.10 Thawing of frozen semen

1. Before use, remove as many straws or cryovials as required from the liquid nitrogen or vapour tank and place them immediately at 37 °C (in an incubator, or even better a dry heat block for contact heating, which can easily be decontaminated between uses).
2. After complete thawing, cut off the end of the straw with sterile scissors and load the insemination device (for therapeutic use) or expel the contents to determine post-thaw motility (to check the freezing process).
3. Remove the cryoprotectant by adding the culture medium before centrifugation for 10 minutes at 500g. Remove the supernatant and dilute the sperm pellet in culture medium to the appropriate volume (402).

In the event that the patients decide to discard their cryopreserved semen, straws and/or cryovials should be removed and discarded in the presence of a witness to confirm it is the correct material.

### 6.4.2 Modified freezing protocols for oligozoospermia and surgically retrieved spermatozoa

Semen that contains only a few motile spermatozoa, and sperm suspensions obtained from the genital tract or testicular biopsy, can be stored for subsequent ICSI.

- If very few spermatozoa are to be cryopreserved, individual strategies are required, dependent on the sample.
  - Special devices are commercially available to cryopreserve even a single spermatozoon, though many of these will require micromanipulation (403). Such devices are then placed in cryotubes and stored in liquid nitrogen according to the producer's recommendations.
  - In the absence of such devices, a strategy of freezing in minimal volume is recommended.
- Epididymal or testicular aspirate fluid containing sperm, and sperm suspensions selected by swim-up or DGC from whole semen (**Section 5.4 on page 165** and **Section 5.5 on page 166**) and resuspended in a sperm preparation medium with **HEPES** buffer and HSA (4 mg/ml) can be cryopreserved with Tyrode's glucose glycerol (TGG) cryoprotectant, or a commercial cryoprotectant according to the manufacturer's instructions.

- Freezing of intact testicular tissue to have spermatozoa for future use requires specific developed protocols.

#### 6.4.2.1 Modified cryoprotectant (TGG)

1. To 40 ml of sterile **Tyrode's** solution add 5 ml of sterile human albumin stock (100 mg/ml), 0.9 g of glucose and 5 ml of glycerol. Filter the solution through a 0.45- $\mu$ m pore filter.
2. Store in 2-ml aliquots at  $-70^{\circ}$ .

See note in **Section 6.4.1.1 on page 177** for in-lab preparation of cryoprotectant.

#### 6.4.2.2 Procedure

1. If the sample volume is greater than 2.0 ml, and if few motile spermatozoa are present, centrifuge at 1 500g for 5 minutes at room temperature.
2. Aspirate the supernatant to leave about 1.0 ml and resuspend the spermatozoa in it. Determine the percentage of motile spermatozoa (PR+NP); if very few motile spermatozoa are present, estimate the number of motile cells under each coverslip.
3. Thaw a 2-ml aliquot of TGG or test yolk buffer (TYB).
4. Add one volume of TGG or TYB to one volume of final sperm preparation, gradually, by mixing.
5. Package in straws or cryovials and freeze as above. If any straws are not full, cap the mini-goblet to prevent the straws from floating when frozen.

#### 6.4.3 Labelling of straws/cryovials and records

A robust coding system for labelling straws or vials is essential. Use the code in all laboratory data sheets and computer databases to maintain the anonymity of donors. Keep the key to the code with the identity of the donor separately and securely. There are many potential coding systems; the important requirement is to have a unique code for each donor or storage client. In case of clients/patients, it is important to identify each straw/cryovial with the name, date of birth, hospital number and the date of storage and any other requirement according to national legislation. The following coding system works satisfactorily.

- Each new anonymous donor is allocated a two-letter code (AA, AB, AC, BA, BB etc., ending with ZZ, after which a new method is needed).
- A three-letter code system is used for patients and known donors: AAA, AAB etc.
- Each specimen from a particular donor is indicated by a number following his personal code. For example, the eighth donation given by donor BT is labelled BT-8.



- The letter code and specimen number should be written on each straw or vial using a black indelible marker. Alternatively, use a printed label with the name and birth date of the patient and the date of storage. This label must be designed for use in liquid nitrogen. Due consideration should be given to whether any label chosen could be compromised over time.
- The mini-goblets (or alternatives) in which the straws are stored should also have a clear marker sticker with the code and specimen number, and should only contain samples from that patient on that occasion.
- Colour coding of larger goblets with multiple samples therein, and mini-goblets, may also be useful for rapid identification.
- As the stored spermatozoa are used, the tally of straws or vials is adjusted in the database.



**Note:** All procedures involving the identity of donor or patient samples, including receipt of samples, preparation and labelling of straws, placement in tanks and thawing of straws for use or discarding, should be double-checked by more than one person and evidence of this checking witnessed in the laboratory records. Ideally a technician should process only one semen sample at any given time.

All samples should have a code allowing its identification during storage and transfer from the semen bank to the receiving centre.

## 6.5 Vitrification

Emerging evidence indicates that vitrification can be a valuable method to cryopreserve ejaculated spermatozoa (404). The principle of the method is the ultra-quick freezing of a small sample volume with direct contact with contaminant-free liquid nitrogen, which should prevent formation of ice and reduce osmotic damage. In-straw vitrification (aseptic vitrification), which uses a closed system and does not require sterile liquid nitrogen, is also possible. Vitrification can be performed for whole semen or selected spermatozoa by using both permeable and impermeable extenders and can be used to cryopreserve single or a low number of spermatozoa (405). At present, however, evidence for better post-thawing parameters after vitrification in respect to conventional methods is limited (406), and, as such, sperm vitrification should be considered an experimental procedure.

### 6.5.1.1 Protocol for direct vitrification

Vitrification, in conjunction with so-called “open” devices, requires direct exposure of the sample to liquid nitrogen, and this exposure poses additional contamination risks. Use of sterile liquid nitrogen is always recommended. The procedure may also be hazardous for the operator, who should always use appropriate protective equipment.

#### Materials

- Cryoprotectants
- Sterile liquid nitrogen



- A box for liquid nitrogen
- A small strainer to collect vitrified spheres
- Cryotubes.

Method (from Isachenko et al. (404))

1. After dilution with an equal volume of extender,<sup>10</sup> semen is plunged directly drop by drop into contaminant-free liquid nitrogen using a disposable container.
2. The obtained spheres are then packaged into cryovials, which are immediately plunged and stored in liquid nitrogen.

### 6.5.1.2 Protocol for in-straw vitrification

In-straw vitrification (aseptic vitrification) methods use a closed system, in double straws (one inside another), completely sealed, being aseptic without directly contact with the liquid nitrogen, vitrifying a larger sample volume (100  $\mu$ l) with a high number of spermatozoa (404, 407, 408). This procedure is less hazardous for the operator.

Materials

- 0.5 ml and 0.25 ml straws
- Vitrification medium
- A box for liquid nitrogen
- Conical tubes of 10 ml
- Warming medium.

Method

1. Prepare 1 ml of medium for vitrification:

- Sperm wash medium or HTF: 0.495 ml
- 0.5 M sucrose dissolved in water (e.g. MP Biomedicals, Cat. 152584): 0.495 ml
- Dextran Serum Supplement (e.g. IrvineScientific, Cat. 9301): 0.010 ml

2. Use selected spermatozoa (free of seminal plasma) by swim-up or density gradient centrifugation according to sperm parameters and the local laboratory protocols.

3. After recovering selected sperm, perform a sperm count, concentrate by centrifugation (8–10 minutes at 300g), remove supernatant completely and add the appropriate amount of vitrification medium to resuspend the pellet (calculated as follows):

- Volume of suspension to vitrify per straw (0.25 ml): 100  $\mu$ l
- Concentration of sperm per straw: 0.1–3.0  $\times 10^6$  sperm

<sup>10</sup> The type of extender, temperature of the cryoprotectant and time the cells are exposed to the cryoprotectant are critical and may influence the effectiveness of the process.

Example:

Sperm recovered:  $15 \times 10^6$  sperm total

Aim for preservation:  $3 \times 10^6$  sperm/100  $\mu$ l (volume per straw)

1 ml =  $30 \times 10^6$  sperm

X vol =  $15 \times 10^6$  sperm recovered

Therefore, X = 0.5 ml of the vitrification medium (with 0.5 ml of the vitrification medium,  $5 \times 100 \mu$ l straws will result, each containing  $3 \times 10^6$  sperm).

4. Mix the pellet of sperm with the vitrification medium only immediately prior to vitrification (room temperature). It is not advisable to expose the cells to the vitrification medium for long periods of time.

5. A 0.25 ml straw must be cut to two thirds of its original length. It is then placed horizontally, and an aliquot of 100  $\mu$ l is dispensed, with the help of a pipette, into the open end. Through the following stages it is imperative that the horizontal position is maintained so that the aliquot is not lost.

6. The straw is then introduced into a 0.5 ml straw, which is heat-sealed at both ends. The straw should immediately be submerged in liquid nitrogen for 5 seconds in a horizontal position with the help of forceps and stored in liquid nitrogen.

#### *Warming after the vitrification procedure*

1. Prepare warming medium.

2. Thaw contents of straws/cryovials in medium prewarmed to 42–43 °C.





# Chapter 7:

## Quality assurance and quality control

7.1 Controlling for quality in the andrology laboratory.....	185
7.2 The nature of errors in ejaculate examination.....	188
7.3 The QA programme.....	190
7.4 QC charts for numerical values.....	193
7.5 QC charts for percentages.....	197
7.6 Assessing $\bar{X}$ and S charts.....	197
7.7 Statistical procedures for analysing and reporting between-technician variability.....	199
7.8 External quality control and quality assurance.....	204
7.9 Frequency and priority of quality control.....	205
7.10 Training.....	206

Quality assurance (QA) is the basis for a laboratory service to deliver reliable services to the users – clinicians and their patients. Quality control (QC) is a set of tools to determine whether the assessments themselves deliver reliable results, while QA is a wider concept – it is not only about the analyses. QA includes all procedures for the laboratory to deliver robust and reliable services. Therefore, QA includes, among many things, procedures for sharing information with patients and referring clinicians, criteria for acceptance of referrals, distribution of results, and handling of errors and complaints of all aspects of the laboratory.

“

Semen examination is uniquely complicated and procedurally difficult to standardize, which can result in wide discrepancies in the assessments of sperm counts, motility and morphology in different laboratories.

”

### 7.1 Controlling for quality in the andrology laboratory

Semen examination is uniquely complicated and procedurally difficult to standardize, which can result in wide discrepancies in the assessments of sperm counts, motility and morphology in different laboratories (9, 409–413). Such discrepancies can be addressed by having standardized procedures and QC measures. The latter can detect and correct systematic errors and reduce technical variability in results.



For medical laboratories, a general international standard exists, ISO 15189 (357), to identify procedures for laboratory quality management and provide support for accreditation for the laboratory by an accreditation body. As an adjunct to the ISO 15189 standard, a technical standard based on the same principles as this WHO manual is under development in the International Organization for Standardization (ISO) for basic semen examination, with expected publication in 2021.

The QA of a laboratory involves the systematic monitoring and evaluation of the various aspects of laboratory services and facilities to maximize the probability that the programme is attaining the established standards of quality.

Some definitions are presented here.

- **Objective of the laboratory (performance standard):** The level of performance desired for a specific service, usually measurable in terms of timing and quantity. It states what the laboratory service is expected to deliver.
- **Indicator:** A variable that measures one aspect of a service that is directly linked to the laboratory objectives. It tells specifically what to measure to determine whether the objectives have been achieved.
- **Quality improvement:** A structured approach to analysing performance and applying systematic efforts to improve it
- **Internal quality control (IQC)** measures the variability in laboratory results. It is useful for detecting overall random variation (precision), as well as any systematic and random differences between different individuals performing analyses (**Section 7.3.2 on page 191**).
- **External quality control (EQC):** Comparisons between different laboratories for one or several measures. It is useful for detecting systematic variations and assessing accuracy. It is also known as proficiency testing (PF) or external quality assessment or assurance (EQA).

The expected benefits of a laboratory quality programme can only be achieved if quality is optimal at every step in the diagnostic process.

QC activities of a laboratory start with the implementation of accurate and controllable procedures for assessments, as described in this manual (**Chapter 2 on page 9**). Besides the technical aspects, attention must also be paid to the qualifications of personnel involved – performance monitoring.

All laboratories performing semen examination should implement a QA programme (**Section 7.3 on page 190**), which describes objectives in methods and procedures to ensure that the results are reliable, i.e. accurate and precise. Due to widespread legal accreditation procedures, QA and EQA programmes are already required by law in some countries. In others, health insurance systems request standardization. While the local available resources and capabilities may not allow the full range of procedures to be implemented, there would be basic or standard routine procedures that should be monitored by either internal or, whenever possible, external QC or QA procedures. The basic routine procedures (**Chapter 2 on page 9**) would include the fundamental parameters of sperm count or concentration, morphology and motility.



More detailed practical handling and an in-depth description of a QC process in the laboratory exist (414).

Table 7.1 Terminology of quality assurance and quality control

Accuracy	Closeness of the agreement of a test result with the true value (or how correct the result is)
Assigned values	Estimates of true values (often derived from the mean of results from a number of laboratories) (target value, consensus value, conventional true value)
Bias	The deviation of a test result from the assigned value; reproducible inaccuracies that are consistently in the same direction (systematic error)
Binomial distribution	A theoretical distribution used to model events falling into two categories, e.g. motile/immotile, viable/non-viable
Bland-Altman plot	A plot of the difference between a series of paired observations against their mean value (x-axis: average; y-axis: difference).
Common cause variation	A source of natural variation that affects all individual values of the process being studied
95% confidence interval	An interval calculated from observed data that includes the true value in 95% of replicates ( $\bar{X} \pm 1.96 \times \text{standard error (SE)}$ or $N \pm 1.96 \times \sqrt{N}$ for counts)
Consensus value	See assigned value
Conventional true value	See assigned value
Control chart	A time-sequence chart showing a series of individual measurements, together with a central line and control limits
Control limits	The maximum allowable variation of a process due to common causes alone; variation beyond a control limit is evidence that special causes may be affecting the process
Cusum plot	A plot showing cumulative (added) deviation from target result; a tool for early warning of <i>bias</i> and <i>drift</i>
Drift	Successive small changes in values leading to a change in accuracy with time; c.f. <i>bias</i>
External quality assessment (EQA)	Comparisons between results from procedures performed locally by different laboratories, undertaken by an external body; useful for detecting systematic variation and assessing accuracy
Good laboratory practice	A set of principles that provides a framework within which laboratory studies are planned, performed, monitored, recorded, reported and archived
In control	A process is in control when all values are within expected control limits
Internal quality control (IQC)	Quality tests measuring the variability in a procedure that exists within a laboratory; such tests evaluate the precision of day-to-day operations; useful for detecting random variation (assessing precision)
ISO	International Organization for Standardization ( <a href="http://www.iso.org">www.iso.org</a> ), a body that sets international standards, including for laboratory quality
Manufactured QC samples	Commercially available samples, manufactured and analysed (assayed) according to manufacturing guidelines
Out of control	A process is out of control when a measured value exceeds expected control limits or is within control limits but shows a significant trend in values; a process that is out of control must be evaluated

Accuracy	Closeness of the agreement of a test result with the true value (or how correct the result is)
PDCA	Plan, Do, Check, Act (Shewhart cycle)
Poisson distribution	A theoretical distribution used to model counts
Precision	Closeness of agreement between replicate measurements; commonly expressed as imprecision (drift; within-, between-, inter- run, batch, assay or laboratory variation); measurements of precision are not affected by bias (see also sampling error)
Proficiency test	A form of EQA where an external body compares results from several laboratories and issue certificates when set levels of performance (quality) are met
Random error	See sampling error (precision error)
S chart	A control chart of standard deviations of measured values against time, used to monitor process uniformity and measurement precision
Sampling error	The error involved in counting a limited number of spermatozoa (inversely proportional to the square root of the number counted); the sampling error (%SE) is the standard error of a count ( $\sqrt{N}$ ) expressed as a percentage of the count ( $100 \times [\sqrt{N}/N]$ )
Shewhart cycle	See PDCA
Special cause variation	A source of variation that is large, intermittent or unpredictable, affecting only some of the individual values of the process being studied (random variation)
Standard operating procedures (SOP)	A set of instructions for how processes and methods should be carried out
Statistical sampling error	See sampling error
Systematic error	See bias
Target value	See assigned values
Variation	The difference between individual results of a process; the cause of variation (error) can be common or special.
$\bar{X}$ chart	A control chart showing means of measured values against time, used to monitor process variability and detect changes from the target values (assessing accuracy)
Youden plot	A graph of values from one sample plotted against another

## 7.2 The nature of errors in ejaculate examination

This section deals with the control of variation due to technical factors (biological variability is primarily discussed in **Chapters 2** and **3**).

The management of QC procedures requires an understanding of the sources and magnitudes of measurement errors. Any measurement has a degree of error, the magnitude of which can be described by a confidence interval with an upper and a lower limit. It is the intent of QC procedures to minimize these variations which otherwise can lead to errors in patient care and management. IQC focuses more on imprecision (variability) of measurements; EQA focuses more on the accuracy (correctness) of laboratory assessments. These quality activities will make the results more reliable, true and useful to clinicians and researchers, and safe for patient care and management.

## 7.2.1 Allowable variation (accepted random error)

There will always be some level or degree of allowable variation, expressed as an acceptable range of values (within lower and upper limits of the range). This range is usually defined by the calculation of a confidence interval (CI). The CI is a statistically calculated range. The most commonly used is the 95% CI, where "95%" means that, statistically, it is 95% probable that the true value is within the interval. Depending on the number of observations, the 95% CI is often close to about  $\pm$ two times the standard deviation (SD). The SD is a measure of the variation of repeated assessments around the average of the assessments. To compare the variability, for instance, between high and low concentrations, the coefficient of variation (CV) can be useful. The CV is calculated by dividing the SD with the average of the assessments, usually expressed as a percentage (note that when the average is close to zero, the CV will be very high (SD divided almost by zero) and practically useless).

When the upper and lower limits of the range are narrow, the measurement can be classified as precise. A narrow range is the result of low variation between repeat assessments. If the analysis yields a result that is close to the real or true value, the result is accurate (or correct). Accuracy is described as the difference between the observed result and the true result.

Errors can be classified as random or systematic.

### 7.2.1.1 Random errors

Random errors give results deviating from the expected true value – sometimes higher, sometimes lower. Random errors are often caused by differences in readings or in sampling and can be assessed from repeated measurements on the same sample by the same observer using the same equipment, or by all staff members performing the specific assessment using all equipment being used in the laboratory for that assessment. The expectation is that the values should not vary much from each other.

### 7.2.1.2 Systematic errors

Systematic errors are also called "bias" and can be more difficult to discover. Systematic errors cause wrong results, in general always too low or too high. They arise from factors that affect the result consistently in either direction, but not specifically increasing the variability in repeated assessment of the same semen sample. Therefore, systematic errors are not detected with repeated measurements.

## 7.2.2 Statistical sampling error

Even if an ejaculate is macroscopically well mixed, the spermatozoa still have some random variation in their distribution, as well as in a fixative or in a medium. Since it is technically and practically impossible to have a count of an entire ejaculate, manual or computer-assisted measurements can only be for a selected but hopefully representative part of the entire sample. The problem is how well the aliquot (sample) taken from the ejaculate (or a sperm suspension) represents the situation in the entire ejaculate. The variation in sampling created by selecting either a fixed volume (for estimating concentration) or a fixed number of spermatozoa (for classifying motility, morphology or vitality) is a random error commonly referred to as the (statistical) sampling error. Some commonly used terminology in this area is given in **Table 7.1 on page 187**.



### 7.2.3 Minimizing the statistical sampling error

Measuring the entire sample is not possible. Another option would be to examine smaller, hopefully representative, portions of the sample in a high number of replicates. Again, this would be too time-consuming and exhausting, and therefore not feasible. So, a balance is needed between the gain in statistical precision (reliability of result) and the actual time and effort needed to achieve it. To achieve an acceptable balance between workload and reliability of results, the recommendations for basic ejaculate examination in this manual include several items (**Chapter 2**):

- positive displacement pipettes for correct ejaculate aliquot volume for dilutions for sperm concentration assessment;
- dilutions (immobilization of spermatozoa) and counting chamber volume (exact volume that is assessed) to facilitate reliable sperm concentration assessment;
- replicate assessments of sperm concentration and motility with comparisons to reduce risk of random errors by poorly representative aliquots;
- sufficient depth of wet preparation for unimpaired sperm motility; and
- sufficient numbers of spermatozoa assessed (400 for motility and concentration; 200 for vitality and morphology) to reduce influence of random distribution.

When the statistical sampling error in a laboratory is determined, it is usually presented with confidence intervals, usually set at the 95% level (with an upper and a lower range). This means that there is a 5% possibility that correct results will not be within the "acceptable range" due to chance variation alone. If a correct result is rejected due to this, there will be an unnecessary repeat assessment. The rationale is that most results that are rejected are expected to be due to sampling errors. In many instances, the frequency of unnecessary repeat assessments can be acceptable. For some, wider limits (e.g. at 2.6× or 3× the standard deviation, instead of the usual 2× level) could be chosen to reduce the frequency of unnecessary repeat assessments (to approximately 1% and 0.2%, respectively, instead of 5%), but the increased risk of accepting more errors must be considered.

## 7.3 The QA programme

Details of the quality management of a laboratory are provided in ISO 15189 (357). An important aspect of complying with the standard and achieving acceptable results is the development and implementation of a continuous QA programme. It monitors and evaluates, on a regular basis, the quality and appropriateness of the data and services that the laboratory provides. It generally includes management, administration, statistical analysis, and preventive and corrective actions. It may use continuous monitoring, which would not only detect and correct problems but would also be able to implement measures that help prevent the occurrence of these problems. The QA programme should be described in a quality manual containing standard operating procedures (SOPs), a detailed set of instructions for the different processes and methods used in the laboratory. Linked to these instructions are a number of forms and documents, including, for example, referral notes, laboratory worksheet report forms, and information leaflets for patients and referring clinicians. The quality manual describes the organizational structure of the laboratory, listing the required skills (training) needed in different positions (job descriptions), as well as schedules for meetings between testing personnel and supervisors, and plans for continuous education, development and training of staff.



### 7.3.1 Laboratory procedures manual

The procedures that are to be regularly performed in a laboratory should be described in a manual. The written SOPs should be strictly followed by all laboratory technicians. These would also be part of the in-house training and service orientation of the laboratory technician staff and are an important reference for non-routine procedures and for troubleshooting processes that are not producing acceptable results.

The essential documents would include referral notes, patient information procedures, schedules of patient appointments, specimen collection, performance of assays, reporting of analytical results, procedures for quality testing, training of new laboratory staff members, testing, monitoring and maintenance of equipment, use of control charts and action procedures to follow when values on these charts indicate a problem (out-of-control assays), and interpretation of test results. SOPs should cover procedures for checking that all equipment is in proper operating condition, including routine checking of operation, a schedule and log of calibration, and documentation on the maintenance of scientific equipment, such as microscopes, centrifuges, pipettes, balances, freezers, refrigerators and emergency equipment (e.g. eye washes and showers). The basic method is to keep a logbook for each piece of equipment, in which all adjustments and calibrations are recorded, using checklists or monitoring tools. These records are useful if a laboratory procedure starts producing out-of-control results.

### 7.3.2 Internal quality control

IQC monitors precision – or how reproducible the results are (minimizing random variations) – and thus indicates, by looking at those results outside the established control limits, when the assay may be faulty or have problems. The QC procedure performed depends on the assessment to be monitored or controlled. Assessments that involve dilution, pipetting or reuse of chambers or that have a number of steps require regular or more frequent testing, whereas an assessment of a fixed slide or video may be tested less often, as there are fewer steps where errors can occur.

A practical way to implement IQC is to include IQC procedures and IQC samples in the laboratory's regular workload and to monitor the results for these procedures using QC charts. In this way, IQC becomes part of the laboratory routine and is conducted according to established local or regional standards. It is important that QC samples are analysed as part of routine laboratory work at best and not treated in a special way. The types of IQC material used to monitor within-person (referring to consistency in a single person's reading of the same type of specimen) and between-technician (referring to consistency between two or more persons' reading or interpretation of the reading of the same specimen) variation can be purchased from commercial sources or made in the laboratory. There are advantages and disadvantages to each approach.

#### 7.3.2.1 Purchased QC samples

There are commercially available IQC samples that come provided with a target value and preferably also with allowable limits of acceptable performance established for that product. The advantage of these is that both accuracy and precision can be evaluated. The variation in semen analysis results in the laboratory can be compared with the variation associated with samples from the approved source. With such samples, the laboratory could establish its own control chart for assessing precision and could use the manufacturer's recommended range for evaluating accuracy



(415), or individual centres may even pursue more stringent levels of values. The disadvantages of purchased IQC samples are their high costs and the fact that they are not universally available. The stability of the samples during shipment and storage may also be considered. There should be a note of how the target values given by the manufacturer were obtained (multiple assessments, CASA, consensus values, trimmed means etc.), if provided.

### 7.3.2.2 Laboratory-made QC samples

The advantages of laboratory-produced IQC samples are the reduced costs, local generalizability, and the fact that the samples can be generated specifically for the laboratory's particular needs. In addition, the samples would not be recognized as different from the routine samples. Many samples, covering a broad range of results, can be prepared, and stored for long periods. Their disadvantage is that the target values are unknown, which may thus lead to a long-term system of systematic bias or error. It is recommended, and sometimes required, that there should be control samples for evaluating an average range of values (e.g. sperm concentration  $50 \times 10^6/\text{ml}$ ), as well as a critical range of values (e.g. sperm concentrations  $< 15 \times 10^6/\text{ml}$ ). Repeated measurements on the sample can generate a mean that is close to the true value for this material.

### 7.3.2.3 Stored samples (purchased or laboratory-made)

Stored semen samples can be used in IQC programmes for assessing sperm concentration and sperm morphology. These have the advantage that the target value is known (for purchased samples), provided (by EQC programmes) or estimated from multiple assessments (for laboratory-produced material), so that systematic errors can be detected from repeated measurements.

#### Sperm concentration

Semen samples of varying sperm concentrations can be diluted and stored. The stored samples can include a broad range from ideal or outstanding to those which are bad or difficult to evaluate. See **Section 8.6.3 on page 239** for instructions on preparing and storing non-agglutinated sperm suspensions for QC of measurement of sperm concentration.

#### Sperm morphology and vitality

For morphology, slides of air-dried, fixed semen smears or fixed and stained semen smears (**Section 2.4.9.1 on page 43**), and for vitality, eosin-nigrosin smears (**Section 2.4.7 on page 26**) can be used. Smears should be chosen from the laboratory's routine samples, with identifying codes masked, and analysed (bearing in mind the considerations noted in the section on **Classification of sperm morphology on page 48**). Samples should be prepared from ejaculates with good, medium and poor characteristics. The slides can be reused, but the quality has to be assessed from time to time. It is best to use a wide range of slides to eliminate the possibility of technicians becoming familiar and being less rigorous in the assessment with certain slides, which may result in biased analyses.

See **Section 8.6.4 on page 242** on how to prepare slides for QC of morphology assessment. If slides are prepared and stored properly, they remain stable for many months or even years. Different slide sets can be alternated or overlapped with each other during transition from one QC set to another.



### Sperm motility

Video-recorded specimens on tape, CD, DVD or shared media platforms, either from the clinic, from EQA distributions or specifically made, can be used for QC. Video recordings should be of a magnification and resolution similar to that observed in the microscope when actual specimens are analysed. The use of a microscope camera and video screen for all daily routine assessments, at the same magnification and contrast as the video recordings, increases the validity of video recordings for QC.

See **Section 8.6.2 on page 235** on how to make video recordings for QC of motility measurements.

#### 7.3.2.4 Fresh QC samples (laboratory-made)

A simple method of IQC is for one or more technicians to make replicate readings or measurements on separate aliquots of a semen sample. The replicate assessments should be performed in the same way as routine semen analyses. This form of QC can be applied to assessments of sperm concentration, sperm morphology, sperm vitality, and – to some extent – sperm motility (see below). The subjective nature of assessments of agglutination and aggregation, and the variability of the mixed antiglobulin reaction test (416), together with the need for live gametes and positive controls, make QC for these assays difficult.

The IQC of measurement of sperm motility in fresh samples presents special problems, since motility often declines over time and thus needs to be assessed first – and at about the same time – by all technicians in a QC programme. The measurement readings would thus become lower in specimen samples which are read after a period of time or long after specimen collection. Slide and coverslip preparations for motility are stable for only a few minutes, so fixed-depth chambers, which can be stable for 30 minutes, can also be used, provided assessments are not done with too large difference in time after ejaculation and at different temperatures. Use of a bridge microscope, or a microscope with a camera linked to one or several screens, allows several technicians to assess the same field from the same preparation at the same time. This is specifically helpful during initial training. An acetate grid can be placed over the monitor to mimic the ocular grid used during live motility analysis (**Section 8.6.2 on page 235**).

Laboratories using CASA systems should follow the manufacturers' procedures for conducting QC. This often involves replaying stored images of moving spermatozoa that are marked as swimming at certain velocities.

## 7.4 QC charts for numerical values

This section describes ways to show and analyse numerical values, primarily for "continuous data" (mainly sperm counts). For proportions, slightly different methods must be used.

The creation and interpretation of so-called control charts are an integral part of QA in the laboratory. To obtain a well-arranged and easy-to-understand display of QC data, there are a number of graphs or charts available. The different charts have various advantages, and the choice should be based on the nature of the problem of accuracy, precision or errors and of the material available. If the laboratory lacks competence in statistics and interpretation of results, it is essential to obtain help



from external competence to ensure that laboratory standards can be monitored using a continuous QA system. The underlying statistical theories and calculations may be complicated, but the graphs themselves are quite easy to understand and interpret.

### 7.4.1 The $\bar{X}$ chart

One chart to use is the  $\bar{X}$  chart, which is designed primarily to detect results that are very different from the target value or detect an overall increase in variation. Systematic errors can be detected by sequential measurement of the same samples. Repeated measurements are made on a sample, and the mean value plotted against time or test suspension examined. Stored samples need to be used, as the procedure depends on knowing the true or target value, which may be provided by the manufacturer (purchased samples) or an EQA programme or estimated (from multiple assessments of the material).

The  $\bar{X}$  chart is a type of Shewhart plot that is used to monitor the mean values of repeated analyses of a constant number of test samples. For example, in 10 IQC suspensions (all originating from one preparation) sperm counts are done by all staff members performing the types of assessments. For each of the suspensions the average of the measurements from the individual assessments is calculated. Then a plot is made of the averages of the 10 suspensions (Fig. 7.1). Target value ( $\bar{X}$ , average of the average values), warning limits and action limits are calculated (Table 7.2). The limits are based on the variation of assessments and the number of persons doing the assessments, and expressed as limits above and under the  $\bar{X}$ .

**Table 7.2** Calculations of values for an  $\bar{X}$  chart

Sperm concentration assessed by four andrologists (A–D) on 10 QC suspensions from one IQC preparation. Warning limits ( $A_2$ ) and action limits ( $A_3$ ) are displayed in Table 7.3.

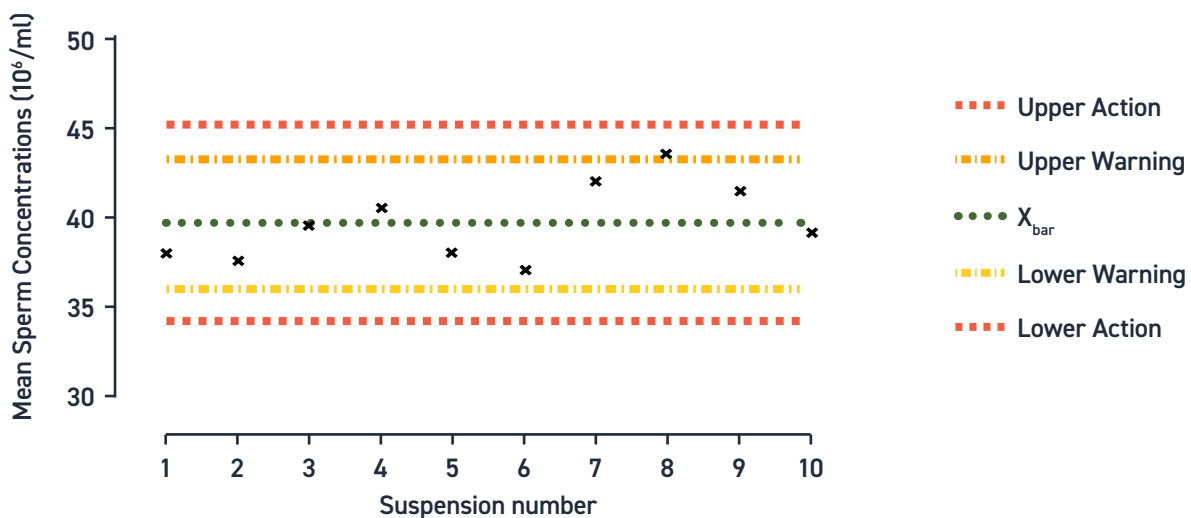
Person	Suspension									
	1	2	3	4	5	6	7	8	9	10
A	38	35	40	34	38	36	44	43	39	43
B	42	36	42	40	40	40	43	43	46	40
C	38	43	40	51	38	33	39	45	35	39
D	34	36	36	37	36	39	42	43	46	34
mean	38.0	37.5	39.5	40.5	38.0	37.0	42.0	43.5	41.5	39.0
SD	3.27	3.70	2.52	7.42	1.63	3.16	2.16	1.00	5.45	3.74
$\bar{X}$	39.7									
S	3.40									



Person	Suspension										
	1	2	3	4	5	6	7	8	9	10	
<b>Warning</b>					$\bar{X}_{bar}$	$A_2$	$S_{bar}$				
Upper	43.3	$\bar{X}_{bar} + (A_2 \times S_{bar})$			39.7	1.085	3.40				
Lower	36.0	$\bar{X}_{bar} - (A_2 \times S_{bar})$			39.7	1.085	3.40				
<b>Action</b>					$\bar{X}_{bar}$	$A_3$	$S_{bar}$				
Upper	45.2	$\bar{X}_{bar} + (A_3 \times S_{bar})$			39.7	1.628	3.40				
Lower	34.1	$\bar{X}_{bar} - (A_3 \times S_{bar})$			39.7	1.628	3.40				

Table 7.3 The factors necessary for calculation of warning and action limits for the  $\bar{X}_{bar}$  chart

No. of technicians ( $n$ )	Warning limit ( $A_2$ )	Action limit ( $A_3$ )
2	1.772	2.659
3	1.303	1.954
4	1.085	1.628
5	0.952	1.427
6	0.858	1.287
7	0.788	1.182
8	0.733	1.099
9	0.688	1.032
10	0.650	0.975

Fig. 7.1 An  $\bar{X}_{bar}$  chart based on data from Table 7.1

The  $\bar{X}_{bar}$  chart is less sensitive than the S chart in detecting whether technicians are producing highly variable results (Section 7.4.2).

## 7.4.2 The S chart

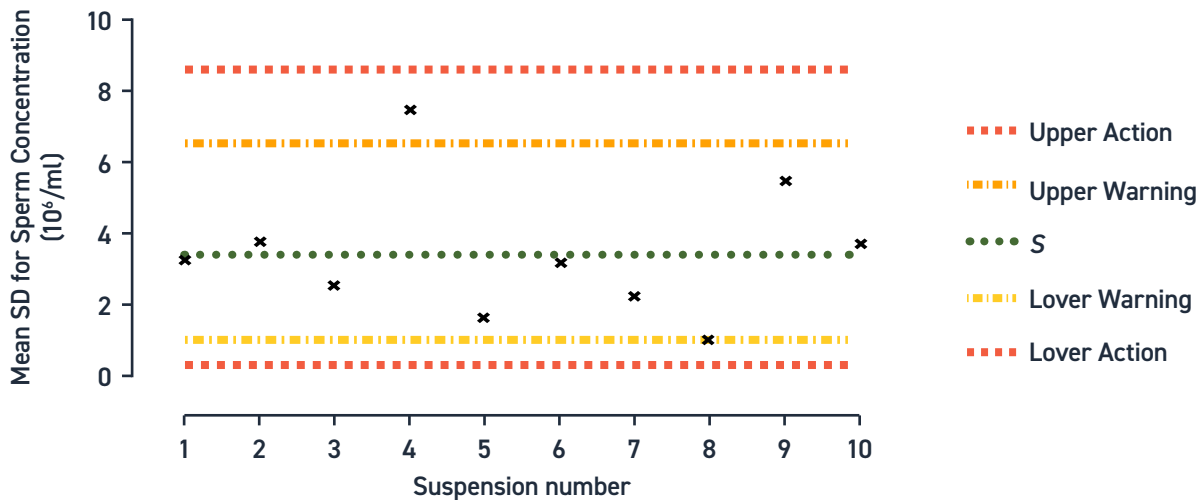
The S chart detects whether technicians are producing highly variable results. Repeated measurements are performed, and the standard deviation is plotted for each assessed sperm solution. Since the QC samples are all from the same stored pool, no differences between samples are expected, so any significant differences between technicians would suggest systematic bias in the assessment by one or more technicians.

In contrast to the  $X_{\text{bar}}$  chart, it is the SD values of the assessments of the 10 suspensions that are plotted in the graph (Fig. 7.2). The target value is the average SD of all suspensions – in this example,  $3.40 \times 10^6/\text{ml}$ . In conformity with the  $X_{\text{bar}}$ , control limits are added to the S chart. However, the warning and action limits are calculated differently than in  $X_{\text{bar}}$  graphs (Table 7.4). Results that fall below the lower limits on the S chart suggest unexpectedly small variation, which may indicate a genuine improvement in the level of agreement between technicians or, in the worst case, inappropriate manipulation of data.

Table 7.4 The calculation of warning and action limits for the S chart

No. of technicians (n)	S control limits and number of assessors			
	Lower action limit ( $s_{0.999}$ )	Lower warning limit ( $S_{0.975}$ )	Upper warning limit ( $S_{0.025}$ )	Upper action limit ( $S_{0.001}$ )
2	0.002	0.039	2.809	4.124
3	0.036	0.18	2.167	2.966
4	0.098	0.291	1.916	2.527
5	0.160	0.370	1.776	2.286
6	0.215	0.428	1.684	2.129
7	0.263	0.473	1.618	2.017
8	0.303	0.509	1.567	1.932
9	0.338	0.539	1.527	1.864
10	0.368	0.563	1.495	1.809
<b>Warning</b>	<b><math>\times 10^6/\text{ml}</math></b>			<b>n</b>
Upper	6.51		$S \times s_{0.025}$	4
Lower	0.99		$S \times s_{0.975}$	4
<b>Action</b>				
Upper	8.59		$S \times s_{0.999}$	4
Lower	0.33		$S \times s_{0.999}$	4

Fig. 7.2 An S chart for sperm concentration



## 7.5 QC charts for percentages

In contrast to QC for continuous or numerical data, results showing categories or classes must use different measures for the calculation of control limits. When spermatozoa are classified into two or more classes (such as normal or abnormal morphology, the four motility classes, live or dead), the standard error of the estimated percentage within a class depends on the true, but unknown, percentage as well as on the number of spermatozoa counted ( $N$ ). The target percentage ( $p$ ) is calculated as the average of repeated assessments of the same test sample. The standard error (variability) of the percentage can, for a percentage between 20% and 80%, be approximated to  $\sqrt{(p(100-p)/N)}$ . For details, see Kuster et al. (417). While the SD of individual readings should be close to these values, the average SD,  $S_{\text{bar}}$ , will exceed 2.5% because of the additional variation between technicians. In this case the goal will be to reduce  $S_{\text{bar}}$ .

## 7.6 Assessing $X_{\text{bar}}$ and S charts

Having good compliance with both the  $X_{\text{bar}}$  and S charts is important, since they can give important insights into the quality of the service provided by the laboratory. In addition, such charts often provide the basis for certification of the laboratories by many agencies.

The laboratory staff and supervisor should review the control charts together. This is best done in regular quality meetings with staff and supervisor, since the quality outcome is a team effort based on joint evaluation and discussion of the performance of the laboratory. If the control values are not acceptable, a systematic evaluation of the entire procedure should be conducted to determine the possible sources of variation.

### 7.6.1 How to recognize out-of-control values

There are basic guidelines for monitoring QC of procedures (414). The QC charts should be examined in the light of these guidelines, and action taken when indicated. There are various rules for declaring a method out of control, and the most important

are given in Table 7.5. In practice, use of the first and last of these rules is generally accepted. The first rule (one result outside actions limits) is the simplest rule. It may indicate a sudden large shift in the process. The last rule (eight consecutive results on one side of the mean) is attractive because it is simple to apply and sensitive to gradual shifts or trends that the first rule might miss.

If the QC sample is “rejected”, the sensitivity (the ability to report the true and correct values of the test) of the alarm to the different types of error (random or systematic) should direct the investigation into possible causes (Table 7.5). The laboratory supervisor should review the QC results regularly.

**Table 7.5 Basic control rules for QC charts**

Control rule	Error indicated
One result outside action control limits	random
Two out of three points outside the action control limits	systematic
Four out of five points outside the warning control limits	systematic
Two consecutive results, both above or both below the upper/lower “warning” limits	systematic
Two consecutive results, one above and one below the upper/lower “warning” limit	random
Eight consecutive results, all above or all below the mean	systematic

### 7.6.2 Causes of out-of-control values

Signals from the QC procedure must be carefully assessed by the entire team to identify any errors that may have caused the out-of-control values. Possible errors (with examples) include:

- inadequate mixing of sample (common with viscous and agglutinated samples);
- technician stress (e.g. erratic sampling or recording error);
- poor technique (e.g. careless pipetting or handling during slide or chamber preparation) (**Section 7.10 on page 206**);
- inadequate training (e.g. systematic differences in the identification of spermatozoa for counting, the classification of normal morphology, the assessment of pink and white sperm heads or coiled sperm tails for sperm vitality, and the detection of motile spermatozoa, or biases from consistent calculation errors) (**Section 7.10 on page 206**);
- instrument variation (e.g. worn or uncalibrated automatic pipettes, which may reduce reproducibility during sampling and dilution; misaligned microscopes, which may reduce optical clarity and prevent proper scoring of vitality or morphology; inaccurate balances or measuring cylinders) (**Section 8.6.5 on page 243**);
- deterioration of the QC samples (based on standardized criteria);

- change in equipment, particularly pipettes and counting chambers; and
- changes in procedures or laboratory environment.

### 7.6.3 Responses to out-of-control values

When results are outside control limits, the probable cause and the corrective action taken should be recorded. If the problem is not obvious, it may be necessary to reanalyse the QC samples to check if the first result was unusual. If the QC result remains outside control limits, the cause or the source of the error must be found and corrected before further assays are performed.

To do this:

1. Create a flowchart of the entire process, step by step. The **SOP and Tables 7.14–7.17 on page 208** can aid this process.
2. From the flow chart, identify areas of potential variation, deduce possible causes, and develop a plan to reduce the variation.
3. Collect more data, make new control charts, and review them to determine if the variability is acceptable for the procedure. This sequence of identifying a problem, developing and testing a hypothesis, and re-evaluating the process is known as the plan, do, check, act (PDCA) cycle.

## 7.7 Statistical procedures for analysing and reporting between-technician variability

QC procedures based on the assessment of fresh semen samples are similar to those for stored samples and allow the variability within and between technicians to be assessed. While there are similarities, there are also differences. For analyses of fresh samples, the true value is not known, so the  $X_{\text{bar}}$  chart cannot be used, and the systematic error (technician bias) cannot be estimated. In this situation, the primary QC procedures are the S chart for assessing variability between technicians, and two-way analysis of variance (ANOVA) for assessing systematic differences between technicians after every 5–10 QC samples.

### 7.7.1 Comparing results from two or more technicians

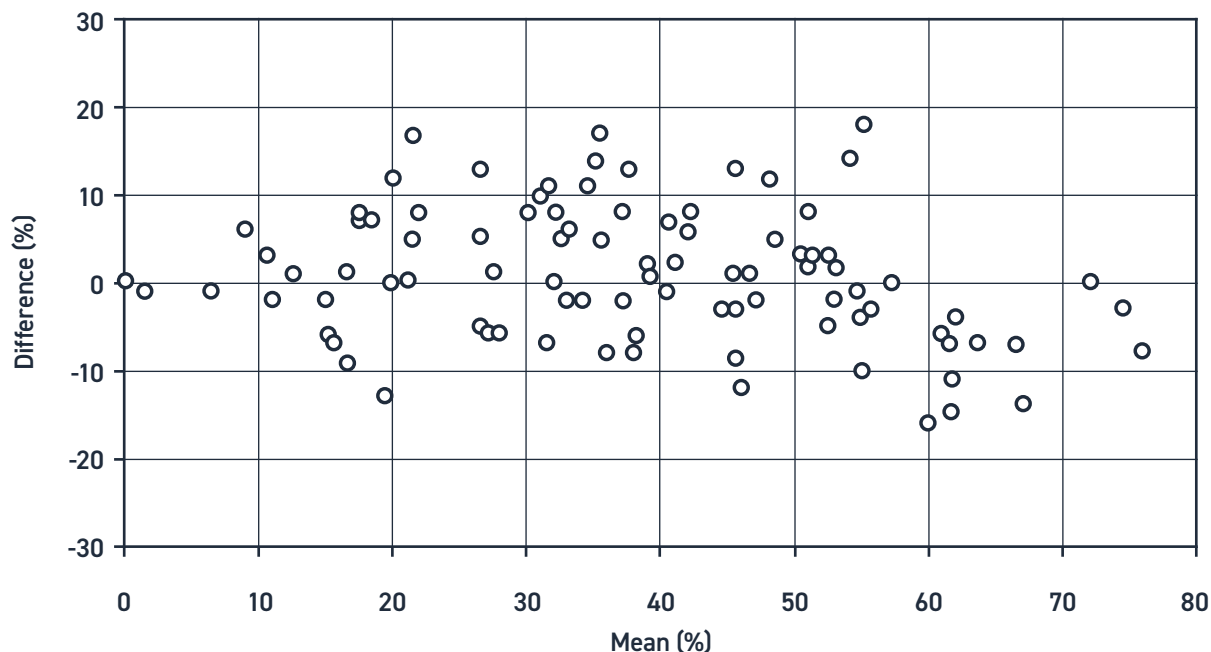
Results from two or more technicians can be compared in several ways.

- Plotting the difference between two estimates against their mean (418). A comparison of estimates by two technicians of sperm concentration from the same sample should produce a pattern similar to that in Fig. 7.3. In a Bland-Altman plot, the average of the two assessments is plotted on the x-axis, and the difference on the y-axis. Ideally all assessments should centre around 0 on the y-axis. General systematic errors are revealed by deviation from the 0-difference level, and differences. In Fig. 7.3, the mean difference of 0.6% indicates that there is little bias; however, the variability (SD 7.6%) is greater than the theoretical sampling error (< 5%). There is also evidence that the CASA method gave higher values than the technicians above 60% (102).



**Fig. 7.3 A Bland-Altman plot of manual and CASA estimates of percentage progressive sperm motility**

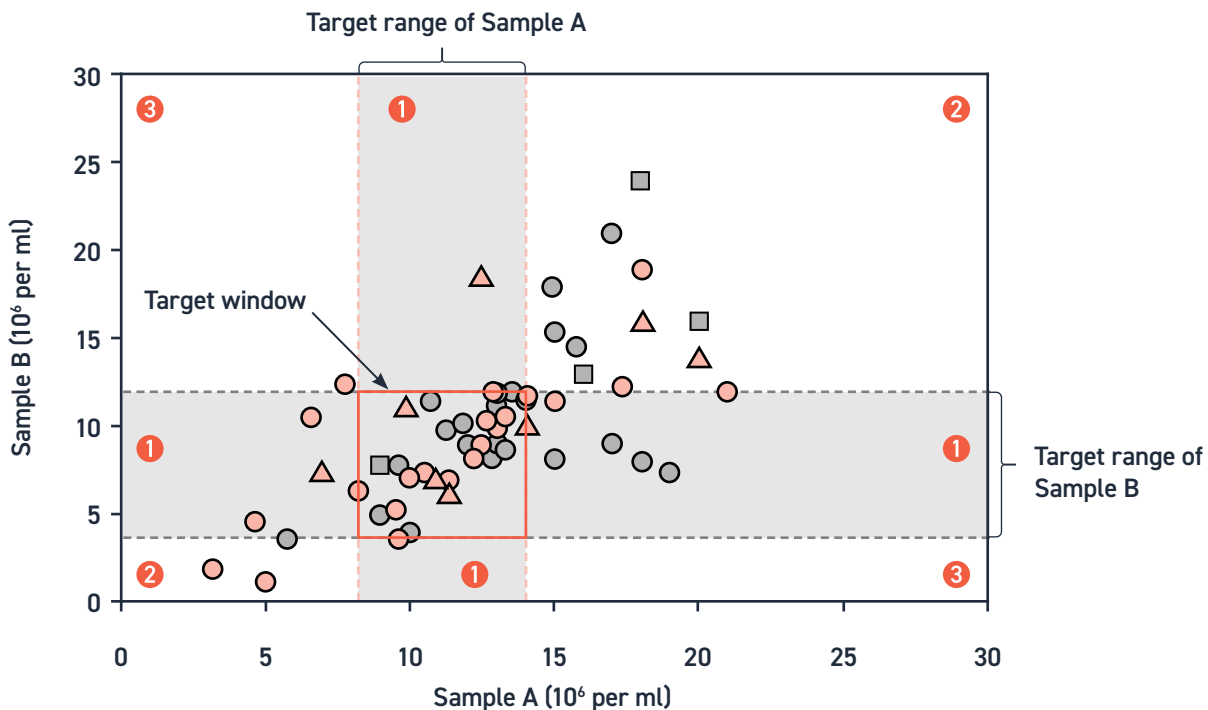
The graph plots the difference between results with the two methods (manual and CASA) (y-axis) against the mean  $((\text{manual} + \text{CASA})/2)$  (x-axis).



- Calculating the mean and SD of the differences (paired comparisons). As the same sample is analysed by both staff members, the difference between means should ideally be zero. Any significant difference from zero, as assessed by a paired t-test, reveals bias (systematic difference) between their assessments.
- Plotting results from two samples against each other (Youden plots). A comparison of estimates of concentration by several members of staff, each examining two separate specimens, should produce a pattern similar to that in Fig. 7.4. For each person (for IQC) or each centre (for EQC), the values for the two specimens are plotted against each other. The dotted horizontal and vertical lines indicate the 95% confidence limits of results from experienced persons (IQC) or reference laboratories (EQC). The area defined by the intersection of these lines is the target window into which the values should fall. This plot reveals both random errors, when the value for one sample is in the correct range but the value for the other sample is not (area labelled 1; one is correct and the other is not), and systematic errors, when both sample estimates are too high (top right quadrant, area labelled 2; both read as too high) or too low (lower left quadrant, area labelled 2; both read as too low). Random errors most likely contribute to one sample being too low and the other too high (area labelled 3).

Fig. 7.4 A Youden plot of estimates of the concentration of spermatozoa

aperson (or laboratory in EQC) can be shown by different symbols and colours. Results in quadrants labelled ② are likely to be due to systematic errors, while those in quadrants labelled ① and ③ are likely to be due to random errors.



- Two-way ANOVA. This technique is described in many statistical textbooks (*e.g.* 419, 420) and is available in statistical packages using statistical tests for the significance of differences between technicians. As with the paired comparison above, differences between all technicians' estimates should ideally be zero. Thus, the differences from the average value are computed for every sample for each person, and the mean and SD of these differences are computed for each individual. Bias is indicated for persons for whom the absolute value of the difference is more than 3 standard errors from the mean difference.

A formal statistical test for differences between staff members is based on the *F*-test from the two-way ANOVA table, which can be obtained directly from most statistical programmes. Mean differences greater than about 2.5 standard errors are unlikely to result from chance variation alone (< 1.2%) and are most likely real or actual. Whether the differences between individuals are significant or not, it is necessary to review the persons' means or mean differences to identify which are greater than expected. Not all computer packages provide the standard error of the differences between individuals, which may have to be computed separately. Substantial differences between persons should prompt a review of all procedures to identify how consistency can be improved.

The worked example in the next section illustrates how to compute the standard error of the differences between staff members in sperm concentration directly and assess whether they are greater than would be expected from chance variation alone. When performing computations directly from the observations, a sufficient number of decimal places must be kept to avoid rounding errors.

## 7.7.1.1 Assessing systematic differences between technicians: worked example

Table 7.6 Sperm concentrations ( $\times 10^6/\text{ml}$ ) estimated by three members of staff on five QC samples

Sample	1	2	3	4	5
A	108	45	100	50	92
B	103	47	102	50	96
C	104	46	89	41	88
Sample mean	105.0	46.0	97.0	47.0	92.0

Table 7.7 Differences from sample mean computed by subtracting semen sample mean from each observation

Sample	1	2	3	4	5
A	3.0	-1.0	3.0	3.0	0.0
B	-2.0	1.0	5.0	3.0	4.0
C	-1.0	0.0	-8.0	-6.0	-4.0

Table 7.8 Mean, SD and the mean/standard error of these differences computed for each member of staff ( $n = \text{number of samples}$ )

	Mean	SD	Mean/standard error	Standard error
	$m_j = \sum_i d_{ij}/n$	$s_j = \sqrt{(\sum_i d_{ij}^2)/(n-1)}$	$(m_j/se(m_j))$	$se(m_j)$
A	1.600	1.949	1.836	0.871
B	2.200	2.775	1.773	1.241
C	-3.800	3.347	-2.539	1.497

For C, the mean difference from the sample mean is  $-3.8 \times 10^6/\text{ml}$ . To assess whether the degree of underestimation is compatible with random variation, a series of calculations must be done (Table 7.9).

Table 7.9 Mean, SD and the mean/standard error of these differences computed for each member of staff ( $n = \text{number of samples}$ )

Step-by-step instruction:	Calculation	Result	Unit
Calculate a measure of variation			
First the sum of $SD^2$ (SD from Table 7.8)	$1.949^2 + 2.775^2 + 3.347^2$	22.702	
Divide sum by 2 [3 individuals minus 1]	$22.702/(3-1)$	11.351	
Calculate the root to obtain <i>error root mean</i>	$\sqrt{11.351}$	3.369	$\times 10^6/\text{ml}$
Calculate the <i>standard error</i> of individual differences and error root mean [3 individuals, 5 samples]	$3.369 \times \sqrt{((1-1/3)/5)}$	1.230	$\times 10^6/\text{ml}$
Compare $3 \times \text{standard error}$ with absolute value of C's mean difference ( $3.8 \times 10^6/\text{ml}$ )	$3.8 > 3 \times 1.230$ $3.8 > 3.691$	Error!	



A formal statistical test of differences between technicians is based on the  $F$ -test. The ANOVA table, using the above sperm concentrations, is given in Table 7.10. The differences between QC samples are very large ( $P < 0.001$ ), since they are taken from different fresh semen samples. The  $F$ -test for differences between persons ( $F = 4.81$  with 2 and 8 degrees of freedom,  $P = 0.042$ ) is significant at the 0.05 level and suggests that these differences are greater than would be expected from random variation alone.

Table 7.10 The  $F$ -test from the two-way ANOVA for technicians and QC samples

Source	Sum of squares	Degrees of freedom	Mean square	$F$ -ratio	$P$ -value
QC samples	9807.6	4	2451.90	216.03	< 0.001
Persons	109.2	2	54.60	4.81	0.042
Error	90.8	8	11.35		
Total	10 007.6	14			

A summary of different procedures primarily for IQC measures is given in Table 7.11.

Table 7.11 A summary of main features of IQC procedures

Procedure	Errors detected	QC material	No. of technicians
$\bar{X}$ chart	bias, overall variability, accuracy	stored	individual, several
S chart	bias/precision	stored/fresh	several
Two-way ANOVA	bias/precision	stored/fresh	several
Bland-Altman	bias/precision	stored/fresh	two
Paired tests	bias/precision	stored/fresh	two
Youden plots	bias/precision	stored/fresh	several

### 7.7.2 Monitoring monthly means

While the primary IQC procedures are based on assessment of differences between and within staff members, additional information may be obtained by monitoring trends in results of semen analysis.

The mean values of each variable for all the patients examined over a certain period (e.g. monthly) can be plotted on an  $\bar{X}$  chart, with warning and action limits 2 and 3 standard errors either side of the mean. The standard error can be estimated from the SD of the original observations divided by the square root of the number of semen analyses in each interval, or directly from the observed distribution of the mean. The control limits should be determined using at least 6 months of observations and should be revised regularly. There should be at least 20 results for each mean; a small laboratory may have to pool results from more than one month. Refinements to the method include monitoring monthly means of patients with normal values and

the use of cumulative sum (CUSUM) charts for the rapid detection of any systematic departures from the mean (421).

Deviations from the expected values may be due to different patient characteristics (time-dependent changes in the subjects being analysed, a change in the number of repeat tests on the same men, changes in the pattern of referral of men with different types of infertility) or technical factors (changes in laboratory staff, laboratory supplies, seasonal temperature variations, equipment, variability between operators).

## 7.8 External quality control and quality assurance

EQC is an integral part of the complete QC process that monitors assay results, while EQA monitors all laboratory procedures relating to collecting and reporting data to ensure that laboratory processes are under control. EQC allows a laboratory to compare its results with those of others measuring the same test. It permits different methods to be evaluated and compared on a scale not possible in a single laboratory.

EQC and IQC are both important, and both should be in place together, as they are complementary processes. EQC may reveal problems with accuracy that may not be apparent from IQC if control samples are not adequately masked or selected. EQC has the advantage that it allows a laboratory to monitor the accuracy and stability of its methods (422). However, as EQC samples are clearly of external origin or of a different matrix, they are liable to be handled in a specific way; this should be guarded against so that they are processed as far as possible in the same way as routine samples.

EQC encompasses peer comparison and proficiency testing programmes, in which specimens presumed to be identical are sent to all participating laboratories for analysis (423). Laboratories submit their results to a central facility, where the data are examined for outliers, and means and SDs are calculated to characterize the performance of the participating laboratories.

### 7.8.1 Assessment of EQC results

EQC schemes provide laboratories with information on both their results and those from other participating laboratories using the same or different methods to measure the specified analyte. It should be ascertained whether specified target values were obtained from accurate measurement, from multiple haemocytometer counts of sperm concentration, from computer-aided analysis of sperm motility or from a group of well-controlled reference laboratories, or are trimmed means of all participating centres. Results are often presented graphically, such as in a bar chart, which provides a quick visual presentation of the results. If the same EQC sample is used on several occasions, the bias and variability of the laboratory's results on this sample will also be reported.

When two samples are provided for analysis, a Youden plot is often constructed in which the values for each sample are plotted on the x- and y-axes (**Fig. 7.4 on page 201**). The extent to which centres differ in their assessment is clearly seen from the scatter and distribution of the plotted values. Additional data can be visualized – for example, by using different symbols or colours to indicate the use of different methods (counting chambers, stains or assessment criteria) or different centres.



When more than two samples are distributed, various aspects of bias (the difference from the designated value) may be given. These include:

- the bias index score (BIS): bias divided by a chosen coefficient of variation  $\times 100$ , which can be positive or negative;
- the variance index score (VIS): this is similar to the BIS but is always positive;
- the mean running BIS or VIS scores (MRBIS, MRVIS), which help ascertain trends.

A low MRBIS and low MRVIS indicate that results are close to designated values; a low MRBIS but high MRVIS could indicate random error, and a high MRBIS and high MRVIS indicate systematic errors. Results reported as successful/unsuccessful or as ranks are useful for laboratory inspection and certification.

A simple way to monitor performance is to plot the laboratory's results (on the y-axis) against the target value (on the x-axis) for each parameter. This shows clearly how close to the line of identity the laboratory's values fall. Alternatively, differences from the target values can be shown on a Bland-Altman plot (**Fig. 7.3 on page 200**).

### 7.8.2 Responses to out-of-control results

The essential information derived from EQC programmes relates to the bias or accuracy of laboratories and laboratory methods. The desired outcome is for laboratories to maintain or improve the accuracy of their methods (422). Laboratories with results that are persistently/consistently higher or lower than the assigned value or mean of the EQC scheme need to reappraise their methods. A wide variation in EQC results is usually associated with wide variation in IQC results and indicates inconsistencies in the testing procedures from sample to sample. Technical procedures should be carefully reassessed to ensure that they conform to the recommendations in this manual.

Appropriate actions include those discussed for IQC (**Section 7.6.3 on page 199**), with retraining of the technicians and retesting of the samples. **Tables 7.14–7.17 on page 208** also indicate potential sources of variation in sperm analysis. Exchange of scientific staff between laboratories is often helpful, and the training of technicians in laboratories with good EQC results can be beneficial. A consultant from a laboratory with good EQC results will often be able to see where methods could be changed to improve reproducibility.

## 7.9 Frequency and priority of quality control

The QC samples should be analysed routinely. The frequency of analysis may be determined by national or local recommendations or mandated by laboratory licensing laws or accreditation agencies, with a minimum number to be agreed upon by national regulatory bodies. These may be influenced by the number of specimens being analysed by the laboratory. Some regulations may require that QC samples are analysed each day that patient sperm concentrations are assessed; otherwise between 1% and 5% of samples should be for IQC.

QC samples should be used:

- to monitor newly employed and existing staff;



- whenever new laboratory equipment, supplies, procedures or batches of IQC samples are introduced; and
- as a possible part of a regular or periodic maintenance programme.

Table 7.12 contains a general guide to scheduling of QC; in practice, the schedule will depend on the workload in the laboratory. Table 7.13 indicates the priority of the different QC protocols; some procedures may not be feasible for laboratories with limited funding.

Table 7.12 Time schedule for QC

<b>At all times</b>	surveillance and correlation of results within samples
<b>Weekly/monthly</b>	analysis of replicate measurements by different technicians
<b>Monthly</b>	analysis of mean results
<b>Quarterly/biannually</b>	participation in EQC
<b>Biannually/annually</b>	calibration of pipettes, counting chambers, other equipment

Table 7.13 Summary of QC tests

Parameter	Material	Target value	Accuracy/bias	Precision	Priority (1 > 2 > 3)
<b>Concentration</b>	IQC fresh	No		S chart, two-way ANOVA	1
	IQC stored	Yes	$X_{\text{bar}}$ chart	S chart	3
	EQC	Yes	$X_{\text{bar}}$ chart	S chart	2
<b>Morphology</b>	IQC fresh	No		S chart, two-way ANOVA	1
	IQC stored	Yes	$X_{\text{bar}}$ chart	S chart	3
	EQC	Yes	$X_{\text{bar}}$ chart	S chart	2
<b>Motility</b>	IQC fresh	No		S chart, two-way ANOVA	1
	IQC stored	Yes	$X_{\text{bar}}$ chart	S chart	3
	EQC	Yes	$X_{\text{bar}}$ chart	S chart	2
<b>Vitality</b>	IQC fresh	No		S chart, two-way ANOVA	1
	IQC stored	Yes	$X_{\text{bar}}$ chart	S chart	3
	EQC	Yes	$X_{\text{bar}}$ chart	S chart	2

## 7.10 Training

A similar approach to QC can be used when staff members are being trained, new assays introduced or modifications to existing methods assessed. Staff member training should include awareness of the approaches outlined below.



### 7.10.1 Practical hints when experiencing difficulty in assessing sperm concentration

- Review the mixing and dilution procedures, chamber grids and calculations. Having a checklist of steps of the procedures may be helpful.
- Read the samples within 10–15 minutes of loading the chamber, after which evaporation has noticeable effects on the position of spermatozoa within the chamber if no humid chamber is used.
- Two staff members should work together, using a bridge microscope or microscope equipped with a video camera and a TV screen to compare dilution, loading and counting procedures. They should count the same loaded chamber, comparing values for rows or grids, to find the source of discrepancies.
- Use a bridge microscope in a counting and training session, or examine spermatozoa in the grid ocular, to decide whether individual spermatozoa are considered on a line and should be eligible for inclusion in the count.
- Review **Table 7.14**.

### 7.10.2 Practical hints when experiencing difficulty in assessing sperm morphology

- Adhere to the guidelines in this manual. Study the micrographs and the relevant commentary for each spermatozoon.
- Emphasize the importance of always examining all four regions of each spermatozoon, using the structured assessment (**Fig. 2.10 on page 50**).
- Pay particular attention to spermatozoa with borderline morphology. They should be classified as abnormal.
- Conduct a scoring and training session using a bridge microscope or microscope equipped with a video camera and a TV screen.
- Review **Table 7.15**.

### 7.10.3 Practical hints when experiencing difficulty in assessing sperm motility

- Make the preparation immediately before assessing. Reduce bias in overall motility by reading only after any drifting has stopped.
- Select the field randomly and do not deliberately select fields with high or low numbers of motile spermatozoa. One way to do this is to avoid looking through the oculars until a field has been selected.
- Do not wait for motile spermatozoa to enter the field before starting to count.
- Analyse quickly; analyse only a small portion of the grid at one time, depending on sperm concentration.



- Avoid counting spermatozoa that swim into the area during analysis by spending less time examining one area of the grid.
- Count progressive, non-progressive and immotile spermatozoa in two stages. If there are problems with the technique, reverse the order of analysis.
- Review **Table 7.16**.

#### 7.10.4 Practical hints when experiencing difficulty assessing sperm vitality

- Pay particular attention to distinguishing between red (dead) and pink (live) sperm heads (spermatozoa with a faint pink head staining are assessed as alive). If the stain is limited to a part of the neck region, and the rest of the head area is unstained, this is considered a “leaky neck membrane”, but not a sign of cell death and total membrane disintegration.
- Use the recommended eosin–nigrosin method (**Section 2.4.7 on page 26**).
- Review **Table 7.17**.

Table 7.14 Sources of variation (error) in assessing sperm concentration

Procedure	Prevention	Control
<b>Pre-analytical (at specimen collection or handling)</b>		
Incomplete mixing of semen samples before making dilution	Training, SOP	Replicate dilutions
Dilution errors (e.g. assuming a 1 : 20 dilution is 1+20, when it is in fact 1+19)	Training, SOP	IQC
Pipetting device out of calibration (e.g. pipette is set to 100 µl but actually delivers 95 µl or 110 µl)	Equipment maintenance, SOP	Replicate dilutions, IQC, EQC
Using an inappropriate pipette (e.g. an air- rather than a positive-displacement pipette)	Training, SOP	Replicate dilutions, IQC, EQC
Using a low volume for dilution, which carries a high risk of unrepresentative sampling	Training, SOP	Replicate dilutions, IQC, EQC
Failure to wipe the residual semen from the outside of the pipette tip before dispensing it into the diluent	Training, SOP	IQC
<b>Analytical (as a result of measurement of the sample being tested)</b>		
Chamber not clean and dry	Training, SOP	Replicate assessments
Chamber incorrectly assembled or loaded (e.g. dirt particles on the pillars may alter chamber height)	Training, SOP	Replicate assessments
Excessive time lag between mixing semen and removing aliquot for dilution (spermatozoa in semen start to settle immediately)	Training, SOP	Replicate dilutions and assessments
Excessive time lag between vortexing the dilution and loading chamber (diluted spermatozoa start to settle immediately)	Training, SOP	Replicate dilutions and assessments
Microscope not properly cleaned or aligned; incorrect magnification	Training, SOP, equipment maintenance	IQC and EQC

Procedure	Prevention	Control
Not waiting long enough after loading chamber before analysis (insufficient time for sedimentation)	Training, SOP	Replicate assessments, IQC, EQC
Haemocytometer chamber not horizontal during sperm settling, or chamber not kept in a humidified environment during settling	Training, SOP	Replicate assessments, IQC, EQC
Misidentification of spermatozoa (e.g. counting debris as spermatozoa or missing hard-to-recognize spermatozoa)	Training, SOP	IQC, EQC
Assessing too few or too many rows on grid (i.e. incorrect calculations); stopping in the middle of a row	Training, SOP	IQC, EQC
Counting too few spermatozoa, leading to high sampling error	Training, SOP	IQC, EQC
Inconsistently scoring spermatozoa on the counting box lines (e.g. overestimating concentration if spermatozoa are scored on top, bottom, left and right borders)	Training, SOP	IQC, EQC
Malfunction of multikey counter	Equipment maintenance	IQC, EQC
Mathematical error in calculating, or correcting for dilution	Training, SOP	IQC, EQC
Use of capillary-filled chamber (unequal distribution of spermatozoa during filling)	Training, SOP	IQC, EQC

Table 7.15 Sources of variation (error) in assessing sperm morphology

Procedure	Prevention	Control
Microscope not properly cleaned or aligned; incorrect magnification	Training, SOP, equipment maintenance	IQC, EQC
Inadequate training before performing analysis	Training	IQC, EQC
Subjective techniques without clear guidelines	Training, SOP	IQC, EQC
Subtle influences of peers on classification systems (may cause changes during analysis)	Training	IQC (control charts)
Semen inadequately mixed when smear was prepared	Training, SOP	IQC
Poor smear preparation (i.e. too thick or too thin)	Training, SOP	IQC
Poor staining technique (i.e. light, dark or too much background staining)	Training, SOP	IQC
Assessing spermatozoa on edge of slide	Training, SOP	IQC
Attempting to score spermatozoa that are not flat, or are overlapping other spermatozoa	Training, SOP	IQC
Not scoring all spermatozoa in area but selecting spermatozoa for assessment	Training, SOP	IQC
Fading of stain over time (for stored IQC samples)	Training, SOP	IQC (control chart)
<b>Post-analytical (related to the manual or electronic reporting of the test result)</b>		
Errors in calculating percentages if not counted in multiples of 100	Training, SOP	IQC, EQC
Malfunction of multikey counter	Equipment maintenance	IQC, EQC

Table 7.16 Sources of variation (error) in assessing sperm motility

Procedure	Prevention	Control
Improper mixing of specimen before aliquot is removed	Training, SOP	Replicate sampling and assessment, IQC
Waiting too long after slide is prepared before analysis (spermatozoa quickly lose vigour)	Training, SOP	Replicate sampling and assessment, IQC
Improper temperature of stage warmer (e.g. too high temperature will kill spermatozoa)	Training, SOP, equipment maintenance	IQC
Microscope not properly cleaned or aligned; improper magnification	Training, SOP, equipment maintenance	IQC, EQC
Lack of eyepiece grid for guidance	Equipment	IQC (control chart)
Analysing around the edges of the coverslip (the spermatozoa die or become sluggish around the outer 5 mm of the coverslip)	Training, SOP	Replicate assessment, IQC
Making the assessment too slowly (other spermatozoa swim into the defined area during the assessment period)	Training, SOP	IQC
Malfunction of multikey counter	Equipment maintenance	IQC, EQC
Errors in calculating percentages if not counted in multiples of 100	Training, SOP	IQC, EQC
Subjective bias (i.e. consistently too high or too low percentage motile)	Training, SOP	IQC, EQC
Preparative procedures that reduce motility (e.g. temperature change, vigorous mixing, contamination with toxins)	SOP	IQC
Non-random selection of fields for analysis; delay in analysis (e.g. waiting until motile spermatozoa swim into the field or grid to begin analysis)	Training, SOP	IQC, EQC

Table 7.17 Sources of variation (error) in assessing sperm vitality

Procedure	Prevention	Control
Microscope not properly cleaned or aligned; improper magnification	Training, SOP, equipment maintenance	IQC, EQC
Improper staining: some recipes give hypo-osmotic conditions that kill spermatozoa	Training, SOP	Comparison with motility
Waiting too long to stain	Training, SOP	Comparison with motility
Rehydration of dried smear, if not mounted directly, will allow stain to leak into all spermatozoa	Training, SOP	Comparison with motility
Overestimation of dead spermatozoa (e.g. perceiving as dead sperm heads with slight pink stain)	Training, SOP	IQC, EQC
Assessing spermatozoa with pink staining restricted to the neck as dead	Training, SOP	IQC, EQC





# Chapter 8: Appendices

8.1 Interpretation of semen examination results.....	211
8.2 Equipment and safety .....	214
8.3 Microscopy for basic ejaculate examination.....	221
8.4 Stock solutions and media .....	226
8.5 Template for a semen analysis recording form.....	233
8.6 QC material.....	235
8.7 National external quality control programmes for semen analysis.....	246

## 8.1 Interpretation of semen examination results

This manual is not a guideline for clinical decisions as the choice of treatment modalities for male factor infertility. Still, it is the responsibility of each laboratory to provide information that can facilitate the interpretation of the results. The most sought-after information is a divide between fertility and infertility. In the first four editions of this manual, traditional consensus limits were provided. In the fifth edition the distribution of values from men who have contributed to a natural conception within 12 months of trying was presented; the lower fifth percentile of this distribution has then often been interpreted as a true limit between fertile and infertile men. It is therefore essential to expand the concept of interpretation of results of semen examination.

### 8.1.1 Distribution of results from men in couples with a Time-To-Pregnancy (TTP) of one year or less

The data presented in the fifth edition (424) have been further evaluated and complemented with data from around 3500 men in 12 countries (5) (see **Tables 8.1, 8.2 and 8.3 on page 212**). It is a huge achievement to collect data from different geographical areas of the globe. It is also of great interest that the distributions do not differ much from the compilation of 2010. The new amalgamation of data is even more rigorous, attempting to include primarily only the most reliable data. Thus, the data in Table 8.2 provide information on the distribution of results from men in couples having a natural conception within one year of trying (TTP  $\leq$  12 months). The lower fifth percentile represents the level under which only results from 5% of the men in the reference population were found. This can be of help to interpret results from an individual patient.

Caution is needed to avoid over-interpretation. The definition of the reference population allows a degree of inconsistency. These men are defined using a limit for when a couple should be regarded as infertile: at least one year of unprotected sexual intercourse without achieving a natural conception (TTP > 12 months). This means that the reference population is defined as men not belonging to couples with



TTP over 12 months. However, some lucky couples have a natural conception within a year despite problems in the ejaculate. Furthermore, other men with perfectly normal ejaculates are categorized as infertile due to mainly female factors. This points to the problem of applying a dichotomous categorization to fertility that must be considered a continuum (425). It is also well known that there is a substantial overlap of semen examination results between fertile and infertile men (6, 8, 426, 427).

The data used for Campbell et al. (5) are freely available from <https://doi.org/10.15132/10000163>, and thus can be examined by investigators, added to and reanalysed, as and when appropriate.

Table 8.1 Definition of reference population in Campbell et al. (5)

Inclusion criteria	Exclusion criteria
<ul style="list-style-type: none"> <li>Men whose partner had a natural conception with a confirmed TTP <math>\leq</math> 12 months</li> <li>Sexual abstinence range between 2 and 7 days</li> <li>Laboratory techniques:               <ul style="list-style-type: none"> <li>Evidence of compliance with WHO 2010 and adherence to Björndahl, Barratt, Mortimer and Jouannet (428)</li> <li>Internal Quality Control</li> <li>External Quality Assessment</li> </ul> </li> </ul>	<ul style="list-style-type: none"> <li>Men who were attending an infertility clinic or undergoing fertility assessment</li> </ul>

Table 8.2 Origin of data for the distribution of results (5)

The table shows the total number of subjects in each study and corresponding to inclusion and exclusion criteria for the compilation of data.

Origin of study		
Country	Continent	Number of subjects
<b>Included in WHO 2010</b>		
Australia	Oceania	206
Norway	Europe	82
United States of America	Americas	487
Denmark, Finland, France, United Kingdom	Europe	826
Denmark	Europe	199
<b>New since WHO 2010</b>		
China	Asia	1200
Egypt	Africa	240
Greece	Europe	76
Islamic Republic of Iran	Asia	168
Italy	Europe	105

**Table 8.3** Distribution of semen examination results from men in couples starting a pregnancy within one year of unprotected sexual intercourse leading to a natural conception. From Campbell et al. (5); fifth percentile given with variability (95% confidence interval)

	N	Centiles									
		2.5th	5th	(95% CI)	10th	25th	50th	75th	90th	95th	97.5th
<b>Semen volume (ml)</b>	3586	1.0	1.4	(1.3–1.5)	1.8	2.3	3.0	4.2	5.5	6.2	6.9
<b>Sperm concentration (10<sup>6</sup> per ml)</b>	3587	11	16	(15–18)	22	36	66	110	166	208	254
<b>Total sperm number (10<sup>6</sup> per ejaculate)</b>	3584	29	39	(35–40)	58	108	210	363	561	701	865
<b>Total motility (PR + NP, %)</b>	3488	35	42	(40–43)	47	55	64	73	83	90	92
<b>Progressive motility (PR, %)</b>	3389	24	30	(29–31)	36	45	55	63	71	77	81
<b>Non-progressive motility (NP, %)</b>	3387	1	1	(1–1)	2	4	8	15	26	32	38
<b>Immotile spermatozoa (IM, %)</b>	2800	15	20	(19–20)	23	30	37	45	53	58	65
<b>Vitality (%)</b>	1337	45	54	(50–56)	60	69	78	88	95	97	98
<b>Normal forms (%)</b>	3335	3	4	(3.9–4.0)	5	8	14	23	32	39	45

## 8.1.2 Other methods for evaluating semen examination results

### 8.1.2.1 Multiparametric interpretation

For a general prediction of live birth in vivo as well as in vitro, a multiparametric interpretation of the semen examination results has been suggested (7–9, 427). Combined reference limits for such interpretation have yet to be developed.

### 8.1.2.2 Decision limits

Male factor infertility is due to a wide range of known and unknown causes, meaning that there is a need for better diagnostic evaluation of men in infertile couples. Semen examination can be useful for diagnosis and treatment of such disorders, e.g. for endocrine work-up and follow-up of endocrine treatments, selection of patients for genetic screenings such as Klinefelter's Syndrome, Y chromosome micro deletions, translocations, inversions, cystic fibrosis mutations and ciliary dyskinesia. Clinically useful decision limits for such investigations need to be developed.

A decision limit is based on clinical and statistical considerations that point to a need for a certain diagnostic or therapeutic intervention (429, 430).

### 8.1.3 Caution for studies on male fertility based on semen examination results

The lower fifth percentile of data from men in the reference population (Table 8.3) does not represent a limit between fertile and infertile men.

## 8.2 Equipment and safety

### 8.2.1 Basic supplies needed in an andrology laboratory

Below is a list of the supplies and equipment needed by an andrology laboratory to perform the basic tests described in this manual.

If you require assistance in finding a source of any of the following supplies, consult the published scientific literature referenced in this manual or elsewhere.

#### 8.2.1.1 General equipment and supplies

- Top pan balance (for weighing semen pots)
- Benches with impermeable work surfaces
- Containers:
  - for disposal of sharp objects
  - for hazardous waste
- Copy of *Laboratory biosafety manual (48)*
- Deep freezer (-20 °C)
- Disinfectant or sodium hypochlorite, 0.1% (v/v) and 1% (v/v) in purified water
- Disinfectant soap or antiseptic skin cleanser
- Disposable gloves
- Eye-wash solution or eye-rinse
- First-aid kit
- Fume cupboard for storage of, and working with, toxic reagents, chemicals or dyes
- Refrigerator
- Shower.

### 8.2.1.2 Supplies and equipment for basic semen examination

- Centrifuges:
  - bench centrifuge capable of achieving 300–500g (for routine sperm handling and for urine), 1000g (for semen markers) and 2000g (for viscous samples). Centrifuges should allow for sealed buckets to minimise aerosol risks.
  - higher-speed centrifuges reaching 3000g (for preparing suspected azoospermic samples) or 16 000g (for obtaining sperm-free seminal plasma). Centrifuges should allow for sealed buckets to minimise aerosol risks.
- Dilution vials
- Filter paper, 90 g/m<sup>2</sup> (for filtering stains)
- Haemocytometers: improved Neubauer or alternative, 100 µm deep with thick coverslip (thickness number 4, 0.44 mm)
- Incubator (37 °C)
- Laboratory film, self-sealing, mouldable
- Laboratory multikey counter (six or nine keys)
- Microscope slides:
  - with ground glass or textured writing surface and coverslips (thickness number 1.5, 0.16–0.19 mm)
  - plain slides for pulling a drop of semen over another to make semen smears
- Pen/pencils:
  - for writing on frosted glass slides: a pencil with lead of softness HB (American rating number 2) is adequate
  - permanent marker pen
- pH paper (range 6–10)
- Phase-contrast microscope (for estimation of sperm concentration, motility, morphology) and the following accessories (see **Appendices 8.3 on page 221**):
  - ×10, ×20 (or ×25), ×40 (or ×63) positive phase objectives, ×100 oil-immersion objective
  - wide-field ×10 (or ×12.5) eyepiece (ocular)
  - eyepiece reticle (for judging area of field scanned for motility)
  - stage micrometer (for sperm morphology measurement)
- heated stage (optional but strongly recommended; for measurement of sperm velocity)



- Pipettes and pipette tips:
  - Pasteur pipettes with latex droppers, or plastic disposable transfer pipettes, or automatic pipettes for mixing semen
  - air-displacement pipettes
  - positive displacement pipettes to measure 10–100 µl
- Record forms for results of semen and mucus analysis (see **Appendices 8.5 on page 232**)
- Sample mixers:
  - two-dimensional shaker or rotating wheel for mixing semen (optional)
  - vortex mixer for diluted and fixed semen
- Semen collection container:
  - disposable wide-mouth containers with lids
  - spot plate, porcelain or borosilicate glass (for eosin–nigrosin test)
- Tissue paper, lint-free.

### 8.2.1.3 Optional equipment

- An analytical balance for weighing chemicals
- Cryopreservation equipment (optional)
- Condoms, spermicide-free, non-toxic (optional)
- Fluorescence microscope and objectives (optional; for high-sensitivity sperm concentration measurements, acrosome reaction tests)
- Incubator (37 °C), with controllable % (v/v) CO<sub>2</sub> (optional)
- Luminometer (optional; for reactive oxygen species (ROS) assay)
- Pen/pencils: a wax/grease pencil (delimiting pen), (optional; for limiting the area of antibody solution on a slide)
- pH (ISFET) electrode (optional; for viscous semen samples)
- Microscope equipment
- ×40 negative phase objective (optional; for eosin vitality test)
- England Finder (glass slide with grid; optional; for QC assessment)
- Sealing tape for 96-well plates (optional; for fructose assay)



- Slide chambers, disposable (optional; for QC sample preparation)
- Spectrophotometer (optional; for semen biochemistry assays)
- Stage micrometer (optional; for sperm morphology measurement)
- Time generator (optional; for QC sample preparation)
- Warming plate, bench top (optional; for pre-warming slides for motility assessment)
- CASA machine (optional).

#### 8.2.1.4 Chemicals

- Papanicolaou stain (recommended)
- Antibodies (optional; CD45 for leukocytes)
- Antifoaming agent (optional; for QC sample preparation)
- Cellular peroxidase kit (optional)
- Cryoprotective media (optional)
- Density-gradient media (optional; for sperm preparation)
- Fructose assay kit (optional)
- Neutral  $\alpha$ -glucosidase assay kit (optional)
- Petroleum jelly (optional)
- Rapid staining kit (optional; for sperm morphology)
- Wax (melting point 48–66 °C) (optional)
- Zinc assay kit (optional).

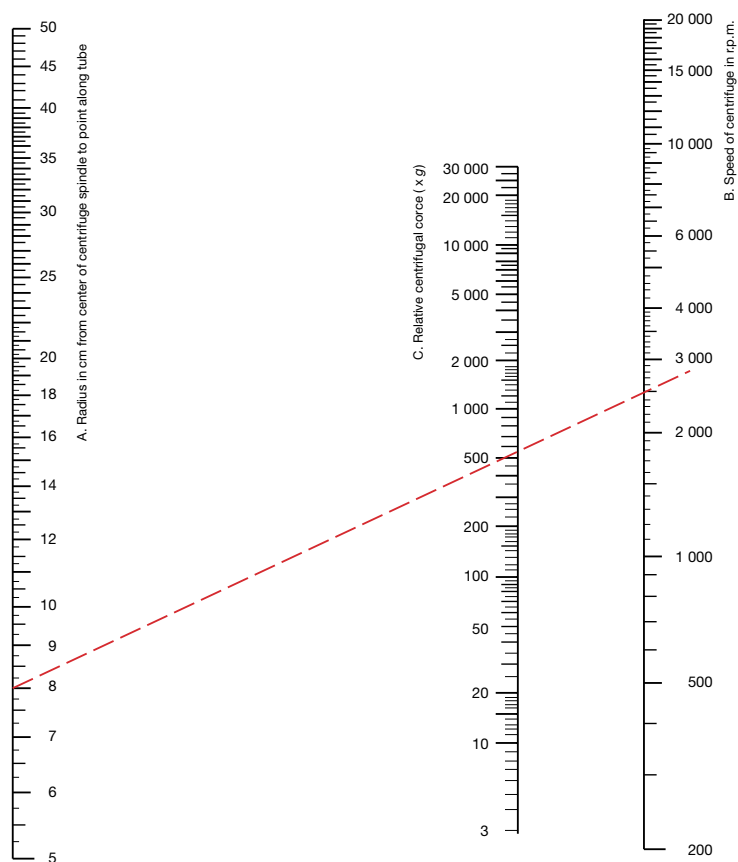
#### 8.2.2 Calculating centrifugal forces

The force to which spermatozoa are subjected during centrifugation (relative centrifugal force, RCF) depends on the speed of rotation ( $N$  revolutions per minute, rpm) and the distance from the centre of the rotor to the point at which the force is to be measured (usually the bottom of the centrifuge tube) (radius,  $R$ , cm). RCF is calculated from the formula:  $1.118 \times 10^{-5} \times R \times N^2$ . For example, with a rotor radius of 8.6 cm, centrifugation at 5000 rpm will produce a force of 2404g; with a rotor radius of 13.5 cm, centrifugation at 3900 rpm will produce 2296g. Fig. 8.1 is a nomogram for determining RCF from the rotor radius and the speed of rotation.



**Fig. 8.1 Nomogram for determining centrifugal force from rotor radius and rotation speed**

A straight line joining the rotor radius (cm, *left axis*) and rotation speed (rpm, *right axis*) intersects the *middle axis* at the RCF. In the example, a radius of 8 cm with a rotation speed of 2500 rpm gives an RCF of approximately 550g. (The calculated value is 559g.)



### 8.2.3 Potential biohazards in the andrology laboratory

Human body fluids, such as semen, are potentially infectious and should be handled and disposed of with special care. For the andrology laboratory, the most important infectious microorganisms that may be found in semen are HIV and hepatitis B and C viruses (HBV and HCV). Laboratory personnel should treat all biological samples as potentially infectious and use appropriate caution in handling them.

### 8.2.4 Safety procedures for laboratory personnel

- A general recommendation is that laboratory personnel who work with human samples should be immunized against hepatitis B.
- No one should eat, drink, smoke, apply cosmetics or store food in the andrology laboratory.
- Pipetting by mouth should not be permitted. Mechanical pipetting devices should always be used for the manipulation of liquids.



- All laboratory staff should wear laboratory clothes (coat, disposable gown or other attire dedicated to laboratory work) restricted to the laboratory. They should wear disposable gloves (rubber, latex or vinyl, with or without powder), especially when handling fresh or frozen semen, seminal plasma or other biological samples and any containers that have come into contact with them. Gloves must be removed and discarded when staff leave the laboratory or use the telephone, computer or other equipment. Gloves should not be reused.
- Personnel should wash their hands regularly, especially before leaving the laboratory, after handling specimens and after removing gowns and gloves.
- Staff should take precautions to prevent accidental wounds from sharp instruments that may be contaminated with semen, and avoid contact of semen with open skin, cuts, abrasions or lesions.
- Measures should be taken to prevent, and where necessary contain, spillages of semen, blood or urine samples.
- All sharp objects (needles, blades etc.) should be placed in a marked container after use. This container should be sealed before it becomes full and disposed of in the same way as other dangerous laboratory items.
- All potentially hazardous items (gloves, semen containers) should be collected and disposed of appropriately.
- Face masks or surgical masks should be worn by all staff performing procedures that could potentially create aerosols or droplets, e.g. vortexing and centrifuging of open containers. The last drops of semen specimens should not be forcibly expelled from pipettes, because this can cause droplets or aerosols to form.
- Staff should wear protective safety goggles, insulated gloves, cryo-apron and closed shoes when necessary, e.g. when using liquid nitrogen (**Section 8.2.6 on page 220**). It is important that these are available in the correct sizes to fit staff members.

## 8.2.5 Safety procedures for laboratory equipment

Work surfaces and non-disposable vessels that have come into contact with semen or other biological samples should be sterilized or disinfected. The following procedures must be performed.

### 8.2.5.1 Daily, on completing the analyses:

- Wash the workspace with disinfectant, e.g. sodium hypochlorite 0.1% (1 g/L) or similar disinfectant, wait at least 1 hour (or overnight), then rinse off disinfectant with water.
- Soak the counting chambers and coverslips in sodium hypochlorite 0.1% (1 g/L) or similar disinfectant overnight. Rinse off disinfectant with water.



### 8.2.5.2 After a spill

- If the outside of a specimen container becomes contaminated, wash with disinfectant, e.g. sodium hypochlorite 0.1% (1 g/L) or similar disinfectant, then rinse with water.
- Immediately after any spill occurs, wash the bench top with disinfectant, e.g. sodium hypochlorite 1.0% (10 g/L) or similar disinfectant, wait at least 4 hours, then rinse off disinfectant with water.

### 8.2.5.3 Heat inactivation of HIV in semen collection vessels

When necessary, heat inactivation of HIV in semen collection vessels can be achieved by:

- dry heat sterilization for at least 2 hours at 170 °C (340 °F); cover with aluminium foil before heating and allow to cool before handling;
- steam sterilization (autoclaving) for at least 20 minutes at 121 °C (250 °F) at 101 kPa (15 psi or 1 atmosphere) above atmospheric pressure;
- continuous boiling for 20–30 minutes.

## 8.2.6 Safety precautions when handling liquid nitrogen

- Liquid nitrogen is dangerous. Always handle it carefully, use only approved tanks, and do not attempt to seal containers. Use tongs to withdraw objects immersed in liquid nitrogen.
- Protect eyes with a face shield or safety goggles; hands with insulated gloves; body with cryo-apron; and feet with closed shoes. These must be available in the range of sizes required to correctly fit the staff members working in the area.
- When liquid nitrogen is spilled on a surface, it tends to cover it completely and therefore cools a large area. Objects that are soft and pliable at room temperature usually become hard and brittle at the temperature of liquid nitrogen.
- The extremely low temperature can cause serious injury. A spill on the skin can produce an effect similar to a burn. The gas issuing from the liquid is extremely cold. Delicate tissues, such as those of the eyes, can be damaged by even brief exposure to the gas, which may not affect the skin of the face or hands.
- Stand clear of boiling and splashing liquid nitrogen, and its issuing cold gas. Boiling and splashing always occur when a warm container is charged or when objects are inserted into the liquid. Always perform these operations slowly to minimize boiling and splashing.
- Avoid touching uninsulated pipes. Never allow any unprotected part of the body to touch pipes or vessels containing liquid nitrogen. The extremely cold metal may stick fast, and the flesh will be torn when attempts are made to detach it.
- Work in well-ventilated areas. A small amount of liquid nitrogen forms a large amount of gas (at room temperature, approximately 700 times its liquid volume).

If nitrogen gas evaporates from the liquid in a closed room, the percentage of oxygen in the air may become low and create a risk of asphyxiation. Oxygen detectors, which trigger an alarm when the oxygen level falls below 17% (v/v), are available and should be used where liquid nitrogen is stored.

- Use only tubes and straws especially made for freezing in liquid nitrogen. Care should always be taken, as even these can explode as they become warm.
- All staff involved in cryogenic procedures involving liquid nitrogen should be availed of suitable training. For the leads with responsibility for the area this should include relevant training from an outside body or the provider of the liquid nitrogen equipment.

## 8.3 Microscopy for basic ejaculate examination

### 8.3.1 Background

The best source of information for a particular microscope is the manufacturer's manual, which should include a diagram identifying all the parts. If such a manual is not available, it may be possible to obtain information on microscope set-up and use from an Internet search.

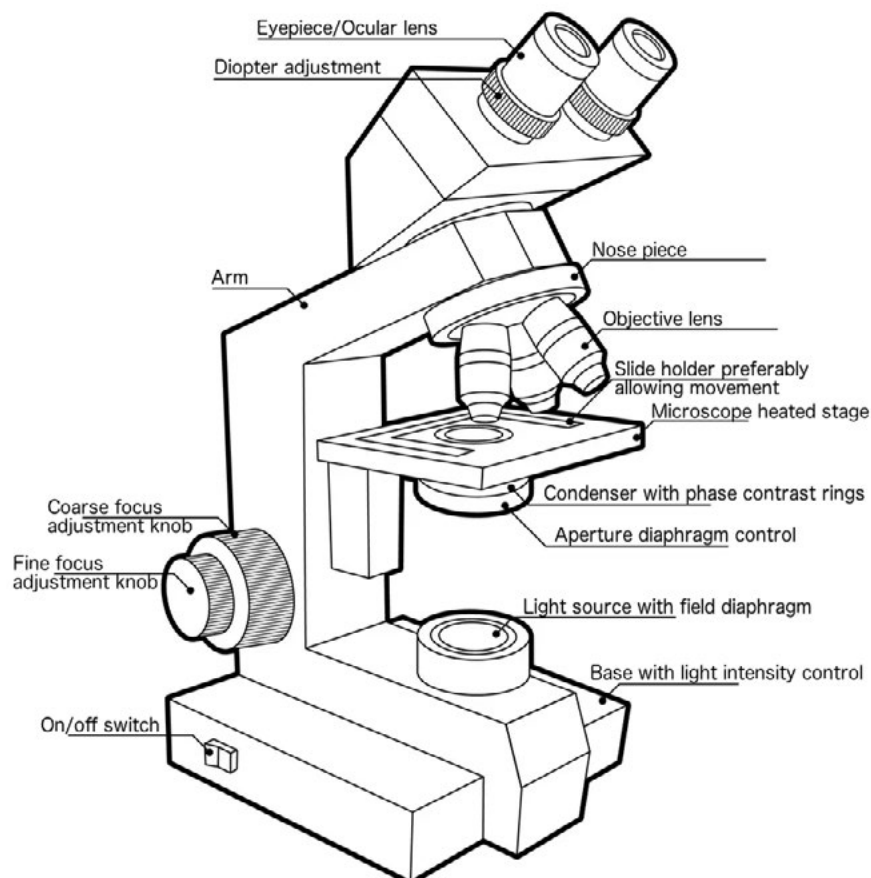
For the semen evaluations described in this manual, a phase-contrast microscope is recommended. The microscope should preferably be binocular (have two eyepieces), with a phase condenser, and should be equipped with  $\times 10$ ,  $\times 20$  (or  $\times 25$ ) and  $\times 40$  (or  $\times 63$ ) phase objectives (for general assessment, motility and counting of spermatozoa and non-sperm cells), and a brightfield  $\times 100$  oil-immersion objective (for assessment of morphology and vitality).

- The quality and price of objective lenses vary considerably. The more expensive objectives offer a better image, but lower-quality objectives may be adequate. It should be considered that with high-quality objectives the laboratory work can cause less strain to the eyes of the personnel.
- Eyepiece reticles (reticules, graticules, eyepiece micrometers) are glass discs with scales of known dimensions, usually 5 mm or 10 mm, or grids of various forms inscribed on them. Some oculars have permanently mounted reticles; others can be unscrewed to allow a reticle to be inserted. They are available in different diameters and should match exactly the diameter of the ocular. They may be calibrated with a stage micrometer to determine sperm dimensions. They are also used to limit the area of the field assessed for sperm motility. The one shown in **Fig. 2.4 on page 27** and **Fig. 8.4 on page 239** is a 5 mm  $\times$  5 mm grid, which is a good size for motility assessment at both  $\times 20$  and  $\times 40$  magnification. Some technicians also prefer this to a 10 mm  $\times$  10 mm grid for estimating concentration or appraising morphology.
- A stage micrometer is a modified microscope slide with a scale etched on its surface, usually 1 mm divided into 10- $\mu$ m sub-divisions. It can be used to calibrate the eyepiece micrometer or reticle grid, and to measure dimensions, e.g. for motility analyses (**Fig. 8.5 on page 239**).



The procedure described below will ensure the best possible image from the microscope. If the light pathway is properly aligned and adjusted, the image will be clear, crisp and less likely to cause eye strain. The following procedures need to be performed when using a new microscope or whenever images are of poor quality.

**Fig 8.2 Section of a microscope**



### 8.3.1.1 The objective lens

Each microscope lens has information on it, such as:

UPlanFl	PlanApo	Plan Neofluor	Plan	S Fluor
20×/0.80 imm corr	40×/0.75 Ph2	100×/1.35 oil iris	100×/1.25 oil Ph3	20×/0.75∞/0.17
160/0.17	∞/0.17	∞/-	∞/0.17 WD 1.0	

**Plan:** a planar lens, permitting a flat field of view, in which everything is in focus

**Apo:** an apochromatic lens that is highly corrected for chromatic aberration

**F, Fl, FL, Neofluor, Fluo, Fluotar, UV, S-Fluor:** a lens that will transmit UV light and is used for fluorescence microscopy

**100×, 63×, 40× etc.:** the magnification of the lens



**0.30, 0.50, 0.80, 1.30, 1.40 etc.:** the numerical aperture (NA) of the lens. This is an indication of the light-gathering ability of the lens. Together with the wavelength of the light used, the NA determines the resolution (the smallest distance between two objects that can be distinguished as separate). Choose the highest NA for best resolution.

**Ph, Ph1, Ph2, Ph3, NP, N:** indicates a lens with a phase ring in it. Ph indicates positive phase rings, and NP or N negative phase. Ph1, Ph2 and Ph3 lenses each require a different phase annulus in the condenser. Positive phase contrast optics permit intracellular structures to be seen (used for wet preparations and motility), while negative phase contrast optics produce white images against a dark background (used for wet preparation vitality or CASA).

**Imm, immersion, oil, W:** indicates a lens designed to work with a fluid – often oil, water (W) or glycerol – between the object and the lens to provide a sharper image. (If not indicated, the lens is “dry” and should not be used with a liquid.)

**Iris:** indicates a lens with an iris controlled by a knurled ring.

**Corr:** indicates a lens with a knurled correction collar that allows the use of immersion media of different refractive indices.

**160, ∞:** the tube length or distance between the eyepiece and the objective. This used to usually be 160 mm but in most modern lenses is infinity (∞).

**0.17, –:** the thickness of the coverslip required for the objective. Coverslip number 1.5 (thickness 0.16–0.19 mm) is useful for most purposes. Haemocytometers need coverslips number 4 (thickness 0.44 mm). “–” means that the thickness of the coverslip is not important or that immersion fluid can be added directly to the slide.

**WD:** working distance – the distance from the front lens element of the objective to the closest surface of the coverslip when the specimen is in sharp focus. The WD generally decreases as the magnification and NA increase, giving rise to lenses with working distances that are normal (NWD, up to 5 mm), long (LWD, 5.25–9.75 mm), extra-long (ELWD, 10–14 mm) and super-long (SLWD, 15–30 mm). Some microscopes may require an LWD lens for use with an improved Neubauer chamber.

**Refractive index:** the extent of phase retardation of light as it passes through a medium. The refractive index (RI,  $n$ ) of a vacuum is 1.0000, of air is approximately 1.0 (1.0008), of water is 1.33, of glycerol is 1.47, and of most immersion oils is 1.515. Mounting media after drying have a similar RI (1.488–1.55) to that of glass (1.50–1.58).

## 8.3.2 Adjusting the microscope

### 8.3.2.1 Loading a sample or stage micrometer for correct focus

1. Place 10  $\mu$ l of semen on a microscope slide, cover with a 22 mm  $\times$  22 mm coverslip (thickness number 1.5, 0.17 mm) and place the slide on the stage. You can also use a stage micrometer, instead of a semen slide, to adjust the microscope.
2. Turn on the light and adjust it to the intensity that gives maximum contrast while being comfortable for your eyes.





**Note:** If the microscope is trinocular (i.e. has a third ocular to which a camera can be attached for photography or video-recording), there will be a light deflection knob, which is generally located to the right of the eyepieces. This knob is likely to have three settings: one to allow all the light to go to the eyepieces; one to allow all the light to go to the camera; and a third to deflect half of the light to the eyepieces and half to the camera.

3. Select the  $\times 10$  positive phase objective lens. Rotate the condenser wheel to correspond to the power of the chosen objective lens.

### 8.3.2.2 Adjusting the oculars

Adjust the space between the oculars (eyepieces) to your own eyes by pulling the oculars apart or pushing them together.

### 8.3.2.3 Focusing the image

1. Rotate the coarse focus adjustment to bring the stage as close to the  $\times 20$  or  $\times 40$  objective as possible. To avoid breaking the objective lens and the slide, look at the objective and stage from the front or side, not through the eyepieces. Use the coarse focus to adjust the height of the stage so that the slide is almost in contact with the objective. Note which way the coarse focus has to be turned to lower the stage away from the objective.
2. Looking through both eyepieces, slowly turn the coarse focus adjustment to gradually move the stage away from the objective, until the specimen is in approximate focus. Use the fine adjustment knob to achieve the best focus.



**Note:** If focus is hard to find, try focusing on the ground glass ends of a slide to get close to the correct focal plane.

### 8.3.2.4 Focusing the oculars

With some microscopes, the two oculars can be focused independently. With others, one ocular is fixed and the other can be focused.

1. Adjustable oculars are usually marked with a "+ / 0 / -" scale. Adjust the ocular to "0" before beginning this process.
2. If one ocular is fixed, look through the fixed ocular only (close or cover your other eye).
3. Focus the specimen image using the fine-focus adjustment. It is helpful to focus on a non-moving object, e.g. a dead spermatozoon, dust particle or stage micrometer grid.
4. Focus the adjustable ocular by looking through it and closing or covering the eye over the fixed ocular. Rotate the knurled ring at the base of the eyepiece to "+" or "-" until the focus is appropriate for your eye.



### 8.3.2.5 Focusing the light condenser

1. Close down the field diaphragm (over the source of light at the base of the microscope).
2. Raise or lower the condenser using the small knobs on the left or right of the condenser unit until the edges of the diaphragm are in the sharpest focus possible, and the circle of light is small and clear. This position will generally be achieved when the condenser is in the top-most position. The edge of the light image may change from blue to red as the condenser is focused (chromatic aberration), and the edges of the condenser will remain slightly blurred. The light may or may not be centred.



**Note:** If the field aperture has no iris diaphragm, focus on a sharp object (e.g. pencil point) placed on the light source.

### 8.3.2.6 Centring the condenser

1. Centre the field diaphragm with the condenser centring knobs. These are generally two (usually knurled) knobs coming out diagonally from the front or side underneath the condenser.
2. Once the light image is centred, open the field diaphragm so that the light just fills the field of view. Do not open the field diaphragm beyond that point.
3. Close the condenser aperture until the glare disappears.

### 8.3.2.7 Adjusting the phase rings

This is done with the use of a centring telescope, available from the microscope manufacturer.

1. Bring into view the appropriate phase annulus in the condenser for the objective being used.
2. Remove one eyepiece and replace it with the centring telescope. Focus the ring of the centring telescope by holding the base of it with one hand and rotating the top portion with the other hand while looking through it. Turn it until the two rings are in sharp focus: one ring is dark (phase annulus), and one light (light annulus).
3. Align these rings so that they are concentric by turning the phase adjustment knobs located on the phase condenser. These knobs are usually located towards the back of the condenser.
4. Replace the centring telescope with the microscope ocular.

### 8.3.2.8 Fluorescence microscopy

Fluorescence microscopy is used to detect the nuclei of spermatozoa in the sensitive counting procedure using Hoechst 33342 dye (**Section 3.1 on page 83**) and the acrosome reaction using FITC-labelled lectin (**Section 4.2.2 on page 144**). The excitation spectral maxima of Hoechst 33342 dye and FITC are 346 nm and



494 nm, respectively, and the corresponding emission maxima are 460 nm and 520 nm. A fluorescence lens is required (**Section 8.3.1.1 on page 222**). Each model of microscope will have, as optional equipment for purchase, the requisite set of dichroic mirrors and barrier filters needed to examine these dyes.

## 8.4 Stock solutions and media

For all solutions, a supply of purified water (distilled, double-distilled or deionized H<sub>2</sub>O) is required for in vitro sperm function testing (for media used for assisted reproduction tissue, culture-grade water should be used). In this edition the use of Ham's F10 medium is not recommended, based on the known negative effects on spermatozoa, sperm function and possible interaction with assays (431).

Whenever handling spermatozoa, the pH (usually pH 7.4) and osmolality of the media are crucial.

### 8.4.1 Buffering of medium pH

The pH of a culture medium can be controlled via the use of either buffering molecules, most commonly HEPES (4-(2-hydroxyethyl)-1-piperazineethanesulfonic acid), or a standard 25 mM bicarbonate buffer system. Bicarbonate buffering is the same equilibrium as the acid-base homeostatic mechanism in living tissues: namely, carbon dioxide (CO<sub>2</sub>) reacts with water (H<sub>2</sub>O) to form carbonic acid (H<sub>2</sub>CO<sub>3</sub>), which in turn rapidly dissociates to form a bicarbonate ion (HCO<sub>3</sub><sup>-</sup>) and a hydrogen ion (H<sup>+</sup>), as shown in the following equilibrium reaction:



Addition of 25 mM bicarbonate to a medium when equilibrated with the correct percentage of CO<sub>2</sub> allows the pH to be clamped/buffered in the medium.

It should be noted that the correct percentage of CO<sub>2</sub> to obtain pH 7.4 is dependent on the partial pressure of the CO<sub>2</sub> and so, most notably, varies with distance above sea level. The 5% CO<sub>2</sub> often quoted is therefore only relevant at sea level, and local adjustment (compensation) of the pCO<sub>2</sub> (via the percentage of CO<sub>2</sub>) should be made to achieve the correct pH (432).

### 8.4.2 Making up media and osmolality

The osmolality<sup>11</sup> or osmolality<sup>12</sup> of a medium is crucial to the behaviour of any cells within it. As such it is a key variable that must be considered should any media be made in-house rather than sourced commercially. It should also always be requested/specified for any commercial media purchased.

It is standard for sperm media (other than the hypo-osmotic swelling test solution) to be in the range of 280–295 mOsm (milliosmoles). To achieve this with the formulations as described, usually the final volume is made and then the ingredient in excess is added slowly until the correct osmolality is achieved, routinely the anhydrous sodium chloride. This would be the preferred option where an osmometer is available for

<sup>11</sup> Osmotic particles per volume of solvent.

<sup>12</sup> Osmotic particles per mass of solvent. When solvent is water, the osmolality and osmolality are essentially identical.





these measurements. The formulations provided suggest “make up to 1000 ml” so that a close approximation is possible where an osmometer is not available.

It is, however, essential to keep in mind that the osmolality increases rapidly in vitro in ejaculates collected in a specimen container and left for liquefaction. Spermatozoa in vitro adjust to increasing osmolality, and this means that exposure of adapted spermatozoa to media with an osmolality of 280–290 mOsm results in a relative hypo-osmotic shock to spermatozoa that could decrease motility and yield of DGC (147).

### 8.4.3 Specifications of chemicals/medium ingredients

Chemicals are specified below with their most common levels of hydration at purchase. Some, for example  $\text{CaCl}_2$ , may be available at different levels of hydration (i.e. anhydrous  $\text{CaCl}_2$ ;  $\text{CaCl}_2 \cdot 2\text{H}_2\text{O}$ ; and  $\text{CaCl}_2 \cdot 6\text{H}_2\text{O}$ ). If a different hydration is used, measured weights must be adjusted accordingly to achieve the correct molarity. Equally it is important to note that many of these chemicals are hygroscopic, so their correct storage is vital, and shelf-life should be respected, or incorrect media will result.

It is expected that chemicals used for these assays are at a minimum of cell-culture grade when available.

Many media listed require the addition of serum. The usual suggestion for diagnostic media is BSA (Fraction V), usually provided as a dried powder, as it provides a cheaper, stable and widely available substitute for human serum. For assays such as acrosome reaction, where functional effects are being assessed, the serum should always be fatty-acid free/charcoal-delipidated to increase batch consistency and avoid effects of contaminants such as hormones. Batch-testing should be performed in laboratories performing these assays routinely.

If sperm are to be used for treatment, then screened human serum (normally provided as liquid) should always be used for in vivo use. The relevant storage conditions and limitations must be followed.

Media with phenol red in the formulation have this addition as a simple useful indicator of pH that aids visual recognition of major pH changes. If fluorescent assays are to be performed, then it is generally recommended that phenol red is omitted, as it increases the background fluorescence of sperm cells and media.

## 8.4.4 Biggers, Whitten and Whittingham (BWW)

### 8.4.4.1 BWW stock solution (433)

1. To 1000 ml of purified water add 5.54 g of sodium chloride (NaCl), 0.356 g of potassium chloride (KCl), 0.294 g of magnesium sulphate heptahydrate ( $\text{MgSO}_4 \cdot 7\text{H}_2\text{O}$ ), 0.250 g of calcium chloride dihydrate ( $\text{CaCl}_2 \cdot 2\text{H}_2\text{O}$ ) and 0.162 g of potassium dihydrogen phosphate ( $\text{KH}_2\text{PO}_4$ ).

2. Adjust the pH to 7.4 with 1 mol/L sodium hydroxide (NaOH).

3. Add 1.0 ml (0.04%, 0.4 g/L) phenol red per litre.

This solution can be stored for several weeks at 4 °C.



#### 8.4.4.2 BWW working solution

On the day of use:

1. Supplement 100 ml of stock solution with 210 mg of sodium bicarbonate ( $\text{NaHCO}_3$ ), 100 mg of D-glucose, 0.37 ml of 60% (v/v) sodium lactate syrup, 3 mg of sodium pyruvate, 350 mg of bovine serum albumin (Fraction V), 10 000 units of penicillin and 10 mg of streptomycin sulphate.
2. Warm to 37 °C before use in an atmosphere of 5% (v/v)  $\text{CO}_2$ , 95% (v/v) air.
3. For incubation in air: add 20 mmol/L HEPES (Na salt: 5.21 g/L) and reduce  $\text{NaHCO}_3$  to 10 mmol/L (28).

#### 8.4.5 Dulbecco's phosphate-buffered saline (DPBS)

1. Dulbecco's glucose-PBS: to 750 ml of purified water add 0.2 g of potassium chloride (KCl), 0.2 g of potassium dihydrogen phosphate ( $\text{KH}_2\text{PO}_4$ ), 0.1 g of magnesium chloride hexahydrate ( $\text{MgCl}_2 \cdot 6\text{H}_2\text{O}$ ), 8.0 g of sodium chloride (NaCl), 2.16 g of disodium hydrogen phosphate heptahydrate ( $\text{Na}_2\text{HPO}_4 \cdot 7\text{H}_2\text{O}$ ) and 1.00 g of D-glucose.
2. Dissolve 0.132 g of calcium chloride dihydrate ( $\text{CaCl}_2 \cdot 2\text{H}_2\text{O}$ ) in 10 ml of purified water and add slowly to the above solution with stirring.
  - To prevent precipitation, add  $\text{CaCl}_2$  separately, slowly and with stirring.
3. Adjust the pH to 7.4 with 1 mol/L (equal to 1 M or 1 N) sodium hydroxide (NaOH).
4. Make up to 1000 ml with purified water.
  - If required, add 0.3 g of bovine serum albumin (Fraction V) per 100 ml before use.

#### 8.4.6 Earle's balanced salt solution (EBSS)

1. To 750 ml of purified water add 6.8 g of sodium chloride (NaCl), 2.2 g of sodium bicarbonate ( $\text{NaHCO}_3$ ), 0.14 g of sodium dihydrogen phosphate monohydrate ( $\text{NaH}_2\text{PO}_4 \cdot \text{H}_2\text{O}$ ), 0.4 g of potassium chloride (KCl), 0.20 g of magnesium sulphate heptahydrate ( $\text{MgSO}_4 \cdot 7\text{H}_2\text{O}$ ) and 1.0 g of D-glucose.
2. Dissolve 0.23 g of calcium chloride ( $\text{CaCl}_2 \cdot \text{H}_2\text{O}$ ) slowly in the above solution with stirring.
3. Adjust the pH to 7.4 with 1 mol/L hydrochloric acid (HCl) or 1 mol/L sodium hydroxide (NaOH).
4. Make up to 1000 ml with purified water.
5. For incubation in air: add 20 mmol/L **HEPES** (Na salt: 5.21 g/L) and reduce  $\text{NaHCO}_3$  to 10 mmol/L (Mortimer and Mortimer, 2014).



### 8.4.7 Supplemented Earle's balanced salt solution (sEBSS)

1. To 750 ml of purified water add 6.8 g of sodium chloride (NaCl), 2.2 g of sodium bicarbonate ( $\text{NaHCO}_3$ ), 0.14 g of sodium dihydrogen phosphate monohydrate ( $\text{NaH}_2\text{PO}_4 \cdot \text{H}_2\text{O}$ ), 0.4 g of potassium chloride (KCl), 0.20 g of magnesium sulphate heptahydrate ( $\text{MgSO}_4 \cdot 7\text{H}_2\text{O}$ ) and 1.0 g of D-glucose.
2. Dissolve 0.23 g of calcium chloride ( $\text{CaCl}_2 \cdot \text{H}_2\text{O}$ ) slowly in the above solution with stirring.
3. Add 3 g of Bovine Serum Albumin (Fraction V).
4. Add 0.30 g of sodium pyruvate.
5. Add sodium lactate (usually as sodium D,L-lactic acid syrup) to a final concentration of 19 mM.
6. Make up to 1000 ml with purified water.

### 8.4.8 Human tubal fluid (HTF)

Original formulation from Quinn et al. (434):

1. To 750 ml of purified water add 5.931 g of sodium chloride (NaCl), 0.35 g of potassium chloride (KCl), 0.05 g of magnesium sulphate heptahydrate ( $\text{MgSO}_4 \cdot 7\text{H}_2\text{O}$ ), 0.05 g of potassium dihydrogen phosphate ( $\text{KH}_2\text{PO}_4$ ), 2.1 g of sodium bicarbonate ( $\text{NaHCO}_3$ ), 0.5 g of D-glucose, 0.036 g of sodium pyruvate, 0.3 g of calcium chloride ( $\text{CaCl}_2 \cdot 2\text{H}_2\text{O}$ ) and 4.0 g of sodium DL-lactate (60% (v/v) syrup).<sup>13</sup>
2. To 1 ml of the above medium add 10  $\mu\text{g}$  phenol red, 100 U penicillin and 50  $\mu\text{g}$  streptomycin sulphate.
3. Adjust the pH to 7.4 with 1 mol/L hydrochloric acid (HCl).
4. Make up to 1000 ml with purified water.
5. For incubation in air: add 20 mmol/L **HEPES** (Na salt: 5.21 g/L) and reduce  $\text{NaHCO}_3$  to 10 mmol/L.

### 8.4.9 Tris-buffered saline (TBS)

1. To 750 ml of purified water add 6.055 g of tris base and 8.52 g of sodium chloride (NaCl).
2. Adjust the pH to 8.2 with 1 mol/L hydrochloric acid (HCl).
3. Make up to 1000 ml with purified water.

<sup>13</sup> Some published formulations use calcium lactate as the lactate source (29).

### 8.4.10 Tyrode's solution

- To 750 ml of purified water add 0.2 g of anhydrous calcium chloride ( $\text{CaCl}_2$ ), 0.2 g of potassium chloride (KCl), 0.05 g of disodium hydrogen phosphate ( $\text{Na}_2\text{HPO}_4$ ), 0.2 g of magnesium chloride hexahydrate ( $\text{MgCl}_2 \cdot 6\text{H}_2\text{O}$ ), 8.0 g of sodium chloride (NaCl), 1.0 g of sodium bicarbonate ( $\text{NaHCO}_3$ ) and 1.0 g of D-glucose.
- Adjust the pH to 7.4 with 1 mol/L hydrochloric acid (HCl) or 1 mol/L sodium hydroxide (NaOH).
- Make up to 1000 ml with purified water.
- If required, add 0.3 g of bovine serum albumin (Fraction V) per 100 ml before use.

### 8.4.11 Papanicolaou stain

Commercially available stains are usually satisfactory, but the stain can be prepared in the laboratory.



**Note:** Check the acidity of the purified water before preparing the different grades of ethanol. The pH should be 7.0.

#### 8.4.11.1 EA-36 (equivalent to EA-50)

##### Constituents

- |  |         |
|--|---------|
| • Eosin Y (colour index 45380)                         | 10 g    |
| • Bismarck brown Y (colour index 21000)                | 10 g    |
| • Light-green SF, yellowish (colour index 42095)       | 10 g    |
| • Purified water                                       | 300 ml  |
| • Ethanol 95% (v/v)                                    | 2000 ml |
| • Phosphotungstic acid                                 | 4 g     |
| • Saturated aqueous lithium carbonate (> 1.3 g/100 ml) | 0.5 ml  |

##### Stock solutions

Prepare separate 10% (100 g/L) solutions of each of the stains as follows:

- Dissolve 10 g of eosin Y in 100 ml of purified water.
- Dissolve 10 g of Bismarck brown Y in 100 ml of purified water.
- Dissolve 10 g of light-green SF in 100 ml of purified water.

##### Preparation

- To prepare 2 litres of stain, mix the above stock solutions as follows:
  - 50 ml of eosin Y



- 10 ml of Bismarck brown Y
  - 12.5 ml of light-green SF.
2. Make up to 2000 ml with 95% (v/v) ethanol.
  3. Add 4 g of phosphotungstic acid.
  4. Add 0.5 ml of saturated lithium carbonate solution.
  5. Mix well and store at room temperature in dark-brown tightly capped bottles.



**Note 1:** The solution is stable for 2–3 months.



**Note 2:** Pass through a 0.45- $\mu$ m filter before use.

#### 8.4.11.2 Orange G6

##### Constituents

- |  |         |
|--|---------|
| • Orange G crystals (colour index 16230) | 10 g    |
| • Purified water                         | 100 ml  |
| • 95% (v/v) ethanol                      | 1000 ml |
| • Phosphotungstic acid                   | 0.15 g  |

##### Stock solution number 1 (orange G6, 10% (100 g/L) solution)

1. Dissolve 10 g of orange G crystals in 100 ml of purified water.
2. Shake well. Allow to stand in a dark-brown or aluminium-foil-covered bottle at room temperature for 1 week before using.

##### Stock solution number 2 (orange G6, 0.5% solution)

1. To 50 ml of stock solution number 1 add 950 ml of 95% (v/v) ethanol.
2. Add 0.15 g of phosphotungstic acid.
3. Mix well. Store in dark-brown or aluminium-foil-covered stoppered bottles at room temperature.



**Note 1:** Filter before use.



**Note 2:** The solution is stable for 2–3 months.

#### 8.4.11.3 Harris's haematoxylin without acetic acid

##### Constituents

- Haematoxylin (dark crystals; colour index 75290)



- 95% (v/v) ethanol
- Aluminium ammonium sulphate dodecahydrate ( $\text{AlNH}_4(\text{SO}_4)_2 \cdot 12\text{H}_2\text{O}$ )
- Mercuric oxide (HgO).

#### Preparation

1. Dissolve 160 g of aluminium ammonium sulphate in 1 600 ml of purified water by heating.
2. Dissolve 8 g of haematoxylin crystals in 80 ml of 95% (v/v) ethanol.
3. Add the haematoxylin solution to the aluminium ammonium sulphate solution.
4. Heat the mixture to 95 °C.
5. Remove the mixture from the heat and slowly add 6 g of mercuric oxide while stirring.



**Note:** The solution will be dark purple in colour.

6. Immediately plunge the container into a cold water bath.
7. When the solution is cold, filter.
8. Store in dark-brown or aluminium-foil-covered bottles at room temperature.
9. Allow to stand for 48 hours before using.
10. Dilute the required amount with an equal amount of purified water.
11. Filter again.

#### 8.4.11.4 Scott's tap water substitute solution



**Note:** Scott's solution is used only when the ordinary tap water is insufficient to return blue colour to the nucleus; it should be changed frequently, e.g. after rinsing 20–25 slides.

#### Constituents

- 3.5 g of sodium bicarbonate ( $\text{NaHCO}_3$ )
- 20.0 g of magnesium sulphate heptahydrate ( $\text{MgSO}_4 \cdot 7\text{H}_2\text{O}$ )
- Several crystals of thymol (if required as preservative)
- 1000 ml purified water.

### 8.4.11.5 Acid ethanol solution

Constituents:

- 300 ml of ethanol 99.5% (v/v)
- 2.0 ml of concentrated hydrochloric acid (HCl)
- 100 ml of purified water.

## 8.5 Template for a semen analysis recording form

The sample record form below is offered as a model. It allows recording of observations made during semen examination using the methods described in this manual. It also includes derived variables, which are combinations of results from the primary data. For traceability, it should be recorded which member of staff performed which part of the entire procedure from patient reception, through examinations to post-examination calculations and reporting results.

The sample record form has multiple columns for recording the results of semen examinations performed at different times. This is a convenient way of presenting serial semen examination results. It may be useful to add extra space in certain parts of the form to allow the recording of comments and observations that cannot be coded. Decision limits, where available and applicable, are given in square brackets.

Table 8.4 Example template for a semen analysis report form

<b>Patient name</b>	<b>Date</b>			
<b>Date of birth, other ID</b>	<b>Sample ID</b>			
<b>Referring clinic/clinician/date of referral</b>				
<b>Information from patient</b>	<b>Abstinence days</b>			
<b>Collection</b>	<b>At lab? Y/N</b>			
<b>Complete collection</b>	<b>Y/N; if N, what is missing?</b>			
<b>Collection time</b>	<b>hour:minute</b>			
<b>Sample delivered if not collection at laboratory</b>	<b>hour:minute</b>			
<b>Severe infection/inflammatory disease in last 6 months? Medication for severe or chronic disease?</b>				
<b>Ejaculate volume (ml)</b>	<b>Net weight of ejaculate</b>			
<b>Examination begun</b>	<b>hour:minute</b>			
<b>Time to examination</b>	<b>hour:minute</b>			
<b>Ejaculate - Macroscopic examination</b>				
<b>Visual appearance (1, normal; 2, abnormal)</b>				
<b>Viscosity (1, normal; 2, abnormal)</b>				



Liquefaction (1, normal; 2, abnormal (minute))			
Treatment (e.g. to induce liquefaction)			
<b>Ejaculate – Microscopic examination</b>			
Aggregations (0, none; 1, some; 2, plenty)			
Agglutination			
pH			
<b>Sperm number</b>			
Total number ( $10^6$ per ejaculate)			
Concentration ( $10^6$ per ml)			
Error (%) if fewer than 400 cells counted			
<b>Motility</b>			
Rapid progressive (a) (%)			
Slow progressive (b) (%)			
Non-progressive (c) (%)			
Immotile (d) (%)			
Total motile (a+b+c) (%)			
All progressive (a+b)			
<b>Vitality</b>			
Vitality (when < 40% motile) (% live)			
<b>Morphology</b>			
Normal forms (%) (or typical or ideal)			
Abnormal heads (%)			
Abnormal midpieces (%)			
Abnormal tails (%)			
Excess residual cytoplasm (%)			
Teratozoospermia index (TZI)			
<b>Non-sperm cells</b>			
Peroxidase-positive cells, concentration ( $10^6$ per ml)			
<b>Accessory gland function</b>			
Zinc ( $\mu\text{mol}$ per ejaculate) [ $\geq 2.4$ ]			
Fructose ( $\mu\text{mol}$ per ejaculate) [ $\geq 13$ ]			
$\alpha$ -Glucosidase (neutral) (mU/ejaculate) [ $\geq 20$ ]			
<b>Any additional comments</b>			
Examination results approved for release by			



## 8.6 QC material

### 8.6.1 Production of semen samples for quality control

QC specimens should ideally be representative of the range of semen samples processed in the laboratory. If only a small number of QC samples are to be analysed, they should be those most relevant to the main activity in the laboratory. For example, in the laboratory of an infertility service, clinically significant ranges (concentration  $15 \times 10^6$ – $50 \times 10^6$  per ml, progressive motility 30–50%, and normal morphology below 5%) could be chosen.

- Aliquots of pooled semen samples can be stored chilled at 4 °C with a preservative, and analysed at intervals for sperm concentration (**Section 8.6.3 on page 239**).
- Spermatozoa may not survive cryopreservation sufficiently well to be a useful source of internal and external QC materials for motility and sperm antibody tests.
- Video clips obtained with the same resolution and magnification as daily motility assessments can be distributed either on established media (e.g. DVD, CD, memory sticks) or by streaming from a source available on the Internet. For the latter it is important that the bandwidth and connection allow uninterrupted download with sufficient resolution and magnification.
- Photographs and video clips can be used for sperm morphology.
- Video recordings are particularly useful for training in motility and morphology assessment, but their use should complement, not replace, replicate assessments of semen specimens.
- Stained semen slides can be used for morphology QC. Fixed smears can also be stored and used to monitor staining. Stained slides may deteriorate with time, depending on the quality of the fixing or staining procedure. However, slides stained using the Papanicolaou procedure described in this manual and stored in the dark at room temperature should last for months or even years.
- Sperm antibody-positive serum may be used for QC of indirect IB tests, but is not recommended for use in direct IB tests.

### 8.6.2 Preparation of a video recording for internal quality control of analysis of sperm motility

This protocol describes how to prepare a video recording to be used for QC of manual motility assessment procedures.

- Record at least five fields to mimic the multiple fields assessed for motility analysis during semen evaluation and to allow at least 400 spermatozoa to be assessed.
- The video recording should contain images from several different semen samples, covering the range of motilities typically seen during routine semen evaluation.
- The video recording can simply have five fields of a few different semen specimens; in other cases, a more complex recording may be needed, e.g. for



standardization between laboratories or in a multicentre study. In this case, more semen samples might be used, and the samples could be repeated randomly throughout the video recording. Repeated samples allow intratechnician precision to be estimated.

### 8.6.2.1 Additional equipment

In addition to the routine equipment for estimating motility, the preparation of recordings for QC requires a possibility to watch video clips from good phase contrast microscopy and to edit with any suitable software allowing separate fields and numbering of recorded samples with and without a calibrated reticle.

### 8.6.2.2 Procedure

1. If several semen samples are available, the entire video recording can be prepared at one session; otherwise, samples can be recorded as they become available.
2. If motility is typically assessed as recommended, at 37 °C, then the recordings should be made at the same temperature using a stage warmer. Likewise, if motility is typically assessed at room temperature, the recordings should be performed at room temperature.



**Note:** If recording is to be done at 37 °C, the stage warmer should be turned on and allowed to reach a stable temperature at least 10 minutes before use.

3. Prepare a recording of at least 10 fields, ensuring that 400 spermatozoa are recorded from 5 different semen samples.
4. For specimens with low semen concentration, more than 10 fields may be necessary to give adequate numbers of spermatozoa for scoring. Video-recording of 10 fields will take several minutes.
5. Video-recording can be done with either a slide with coverslip or a fixed 20 µm deep chamber.



**Note 1:** When disposable counting chamber slides are used, motility will be stable for a longer period of time than when slides and coverslips are used. This will allow all 10 (or more) fields to be recorded from the same preparation.



**Note 2:** When slides and coverslips are used, it may be necessary to use several during the video recording to avoid a noticeable decline in motility.

6. Identify several semen samples with a range of motility values.
7. Each specimen should have a unique code on the video recording. The coding can vary from simply marking each specimen, to marking each field of each specimen. For example, the first specimen marker could be at the beginning of the first field, with no other coding until the second specimen appears. Alternatively, the coding could include

markings of each individual field, i.e. the first field of the first specimen would be marked 01-01, the second field of the first specimen would be marked 01-02 etc. This more elaborate marking system helps the technicians track where they are during analysis.



**Note 1:** When disposable counting chamber slides are used, motility will be stable for a longer period of time than when slides and coverslips are used. This will allow all 10 (or more) fields to be recorded from the same preparation.



**Note 2:** The easiest way to get a blank segment when recording is to cover the light source.

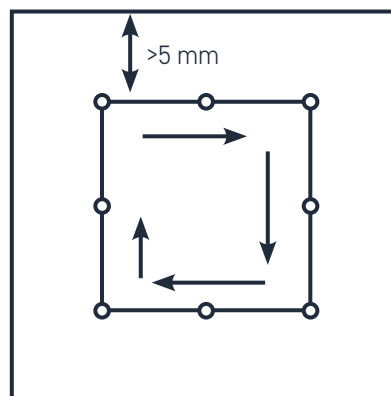


**Note 3:** This can also be done before pausing the recording; the “pause” button should always be used rather than the “stop” button, as the “stop” button may cause noise on the recording.

8. Record an image of a stage micrometer for 10 seconds at the magnification that will be used for recording the samples. The magnification should provide an image on the monitor similar to that used for visual microscopic analysis. The stage micrometer image gives a permanent record of the magnification, which permits calibration of the screen-overlapping acetate grid for use during analysis of the videotape or calibration of a CASA instrument.
9. Record the coding image for the first specimen for 5–7 seconds. At the end of this time, block the light source for 3 seconds to give a blank image to serve as a marker, then pause the recording.
10. Identify the first semen specimen to be used for recording. Place 10  $\mu\text{l}$  of well-mixed semen on a glass slide and cover with a 22 mm  $\times$  22 mm coverslip, or load a fixed slide chamber with 7  $\mu\text{l}$  of well-mixed semen. Allow the sample to settle for a few seconds (at 37  $^{\circ}\text{C}$  if required) until drifting has stopped. Record 10 or more fields, following the pattern shown in Fig. 8.3. For CASA QC, the sperm concentration should not exceed  $50 \times 10^6$  per ml; more concentrated samples may have to be diluted in homologous seminal plasma.

**Fig. 8.3 Aids to assessing sperm motility**

Systematic scanning of fields for video-recording of sperm motility at least 5 mm from the edges of the coverslip.



11. Choose the first field near the upper left section of the coverslip or chamber, at least 5 mm from the edge. Record the field for 15 seconds, keeping the microscope and the stage as still as possible. After 15 seconds, record a 3-second blank and pause the recording. If individual fields are being coded, change the code number and record an image containing only the code number for 5–7 seconds.
12. Following the pattern shown in Fig. 8.3, locate a second motile field on the slide or chamber, and record this field for 15 seconds. Again, include a 3-second blank at the end of the 15 seconds. Pause the recording and, if desired, change the code number to indicate the third field. Continue recording in this way until a total of at least 400 spermatozoa (10 fields or more, depending on the concentration) have been captured. After recording the final field and a 3-second blank, stop the recording.
13. Prepare a second sample. Record the coding image for Specimen 2 for 5–7 seconds, followed by a 3-second blank.
14. Record the second sample according to the steps above, recording 10 or more fields for 15 seconds each, with a blank between each field and a blank at the end of the final field.
15. Repeat this process until the desired number of specimens have been video-recorded.



**Note 1:** If a more complex IQC motility video recording, containing randomly repeated specimens, is desired, either a second recorder or a computer equipped with specialized video editing software is required.



**Note 2:** In the latter case, each specimen should be video-recorded separately, with only the fields marked. The specimen number should not be recorded, as this will change as the specimen is repeated on the recording.



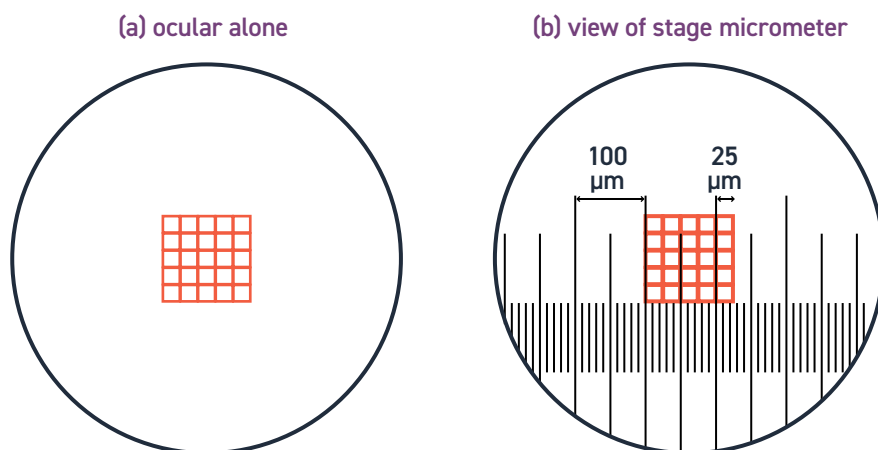
**Note 3:** If a computer equipped with video-editing software is available, images from each specimen can be digitized and combined as desired.

### 8.6.2.3 Analysis of the video recording

1. Draw an acetate grid overlay and place it over the video monitor to be used during analysis of the video recording, as detailed below. This will mimic the grid used in the eyepiece during microscopic analysis (Fig. 8.4).

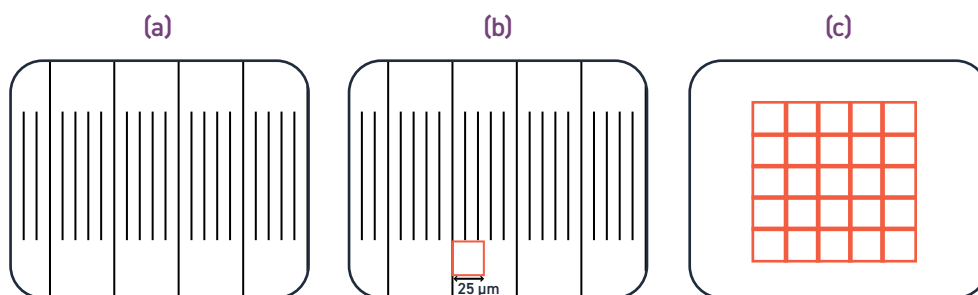


Fig. 8.4 View through an ocular with reticle (red grid)



- Place the stage micrometer on the microscope stage at the magnification used for motility analysis. Looking through the ocular with reticle (Fig. 8.4), measure the size of the grid sections using the stage micrometer. In this example the reticle grid is  $125\ \mu\text{m} \times 125\ \mu\text{m}$  and each square is  $25\ \mu\text{m} \times 25\ \mu\text{m}$ . Make a note of these measurements.

Fig. 8.5 View of the videotaped image of the stage micrometer on the monitor and the drawn overlay



- Play the recording through the video monitor and pause at the image of the micrometer (Fig. 8.5).
- Tape an acetate sheet over the screen and draw a square the size of one square in the eyepiece reticle grid, as measured above (see Fig. 8.5b).
- Complete the image of the entire eyepiece reticle grid (25 squares) (Fig. 8.5c).
- To analyse the video recording, secure the acetate grid overlay over the video monitor. The analysis should be done on a standardized section of the grid overlay, e.g. the top two rows or the middle three rows.
- Score replicate assessments of 200 spermatozoa for each recorded segment.

## 8.6.3 Preparation of diluted semen for internal quality control of determination of sperm concentration

### 8.6.3.1 General considerations

- Some steps of the procedure for determining sperm concentration in semen can be monitored using diluted, preserved semen samples prepared in the laboratory.
- The IQC samples should be representative of the range of concentrations normally seen in the laboratory during routine semen evaluation.
- Dilute the semen in a preservative, and place aliquots in storage vials. These can be refrigerated and used later for counting. Vials should be verified airtight and validated that sperm do not adhere to the internal walls.
- Take care when preparing the suspensions to mix the specimen thoroughly, to ensure that vials prepared from the same specimen contain identical concentrations of spermatozoa. In this way, differences in counts on the IQC samples can be attributed to problems in the counting procedure.
- Dilute the preserved IQC samples again before assessing the concentration using a haemocytometer. Use the final dilution that is used in the laboratory during routine counting. This ensures that the concentration of background debris and other non-sperm cells will be similar to that seen during routine evaluation. For example, if the semen is initially diluted with an equal volume of preservative, an additional 1+9 (1 : 10) dilution would yield a final dilution of 1 : 20.
- When a preserved sample with low sperm concentration is desired, it is better to start with a low-concentration semen specimen rather than making a large dilution of a more concentrated specimen. This will ensure that the background is similar to that observed during routine semen analysis.
- Swim-up sperm preparations lack the debris, loose heads and cell fragment contamination seen during routine semen evaluation and are best used only for monitoring the counting of similarly selected sperm suspensions.
- The number of sperm suspensions for IQC prepared at one time will depend on the number of technicians and the frequency of counting.
- Preserved diluted semen kept under refrigeration should be stable for at least 4 months.

### 8.6.3.2 Reagents

Either of the two preservatives below may be used, as follows. Such solutions can become contaminated and should be discarded and renewed regularly.

- Formalin (10% (v/v) formaldehyde): to 27 ml of purified water add 10 ml of 37% (v/v) formaldehyde.
- Agglutination-preventing solution (APSYS) (141): to 100 ml of purified water add 1.0 g of BSA, 2.0 g of polyvinylpyrrolidone (PVP), 0.90 g of sodium chloride (NaCl), 0.1 ml



of detergent Triton X-100 and 0.004 ml of silicone antifoaming agent. Mix thoroughly and pass through a 0.45- $\mu$ m filter to eliminate debris. Store at 4 °C.



**Note:** The bactericide sodium azide can be added to APSIS (and 0.10 g of sodium azide) to make the solution toxic. However, due to safety considerations this is not recommended.

### 8.6.3.3 Additional supplies

In addition to the routine equipment for estimating sperm concentration, the preparation of QC samples requires:

- cryovials or other small tubes with tight-fitting lids for storage
- permanent markers for labelling tubes.

### 8.6.3.4 Procedure

1. Identify semen samples of the approximate desired concentration. The volume of preserved semen required will vary according to the needs of the laboratory; either use the entire volume of semen available or prepare 4 ml of diluted sperm suspension for each concentration.
2. As soon as possible after collecting the semen, dilute it with preservative. If APSIS is used for dilution and preservation, the longer the time before dilution, the greater the chance of crystal formation following dilution. These crystals can interfere with loading the chamber and counting sperm.
3. Transfer the volume of semen required to a 15-ml centrifuge tube. For each ml of semen, add either 100  $\mu$ l of 10% (v/v) formalin, 10  $\mu$ l of 3 mol/L azide or 1 ml of APSIS.
4. Label all vials to be used for storage of the samples with identifying information and the date of preparation. Lids or tops should be removed, and the vials placed in a rack to permit quick and easy filling.
5. Ensure that the diluted semen is thoroughly mixed throughout the allocation process, to ensure that all vials contain similar sperm concentrations. Even minor delays after mixing can allow the spermatozoa to begin to settle, altering the concentration in the aliquots. One way to ensure constant mixing is to place the centrifuge tube of diluted semen in a rack, and then mix the semen continuously with one hand using a plastic transfer pipette, while removing the aliquots using a pipette in the other hand.
6. Depending on the needs of the laboratory, each vial should contain 0.5–1.0 ml. Storing the samples in 0.5-ml aliquots allows several counts to be made from each vial.
7. Once the diluted sperm suspension has been distributed to all the vials, they should be tightly capped. Depending on the type of vial used, the interface between the tube and the lid can be covered with a strip of self-sealing laboratory film, to ensure a good seal. This is not necessary if cryovials are used.



8. Repeat the entire process for the remaining semen samples.

9. Store the vials at 4 °C.



**Note:** The concentration of the IQC solutions should be determined after the dilutions have been prepared and should not be assumed from the original semen concentration. Once the preserved sperm suspensions have been prepared, a vial can be removed as needed and assessed. The results can be charted using the procedure described in **Section 7.7 on page 199**. All counts should be done using the counting method typically used in the laboratory. The section below describes the procedure using the haemocytometer.

#### 8.6.3.5 Using the stored IQC samples

- The preserved solutions must be diluted before counting; the dilution will depend on the preservative used.
- The dilution of semen with formalin and azide is minimal, so it does not need to be taken into account. Semen preserved in APSIS is diluted twofold (i.e. 1+1 (1 : 2)), and this must be taken into account in the final calculation of concentration.
- For suspensions diluted in APSIS from semen with an original concentration above 25 million per ml, counting is best accomplished using a further 1+9 (1 : 10) dilution. This can be obtained by adding 50 µl of preserved sperm suspension to 450 µl of purified water. This yields a final semen dilution of 1 : 20. Do not use APSIS as diluent, because this will interfere with the sperm settling on the haemocytometer grid.
- For the following steps, all pipettes should be preset to the appropriate volume and preloaded with a clean tip for quick removal of the aliquot immediately after mixing.
- A dilution vial should be prepared with the appropriate volume of water (i.e. 450 µl if making a 1 : 10 dilution as suggested above). The contents of the storage vial should be well mixed on a vortex mixer for approximately 30 seconds at maximum speed. A 50-µl aliquot should then be transferred to the dilution vial containing water. The dilution vial should then be vortexed for 20 seconds at maximum speed. The haemocytometer should be loaded with 10 µl of suspension, and the spermatozoa counted as described in **Section 2.4.8 on page 28**.
- If the original semen sample used to prepare the preserved semen had a low concentration of spermatozoa, the dilution for counting will need to be adjusted accordingly. For example, if the original semen concentration was in the range of 4–25 million per ml, to create a final dilution of 1 : 5 as in the laboratory, the appropriate additional dilution of APSIS-preserved semen would be 2 : 5 (2+3, since the semen has already been diluted 1+1 (1 : 2) with APSIS). This can be achieved by diluting 50 µl of the preserved semen with 75 µl of purified water.
- Preserved sperm suspensions stored in the refrigerator should be stable for at least 4 months, at which time new solutions should be prepared. It is desirable to have a period of overlap, where the old and new solutions are both run to monitor the transition period.





## 8.6.4 Preparation of slides for internal quality control of assessment of sperm morphology

### 8.6.4.1 General considerations

- Smears can be prepared in the laboratory for use in IQC of morphology staining and analysis.
- Multiple smears can be prepared from each of several different semen samples, representing the range of morphology scored in the laboratory.
- The smears can be fixed and stored for later use to monitor the staining and analysis procedures.
- Stained smears can be used individually or in replicate for QC of the morphology analysis procedure.
- Use of replicates allows intratechnician precision to be determined. These QC slides are also useful when comparing results from different technicians within a laboratory, or when comparing analyses between laboratories.
- Papanicolaou-stained and mounted smears, stored in the dark at room temperature, should be stable for many months or even years.
- The semen must be mixed thoroughly throughout the entire process of smear preparation, to ensure that all the smears prepared from a particular semen sample are identical. In this way, any major variation detected during analysis can be presumed to be a result of the process being monitored (i.e. the morphology analysis procedure) and not caused by inadequate mixing of the semen during slide preparation.

### 8.6.4.2 Procedure

1. Transfer the semen from the specimen container into a 15-ml centrifuge tube. This will allow easier and more thorough mixing during the slide preparation process.
2. Clean both surfaces of frosted glass slides by rubbing vigorously with lint-free paper tissues.
3. Label the frosted slides with identifying information (e.g. identification number and date), using an HB (number 2) lead pencil. Pencil markings are stable through fixation and Papanicolaou staining of slides; ink from pens and some permanent markers is not.
4. Attach a clean tip to the pipette and set the volume to 10  $\mu\text{l}$  (or the volume routinely used in the laboratory for preparation of morphology smears).
5. The semen must be thoroughly mixed during the entire process, to ensure that all smears are as similar as possible. After mixing, even minor delays before removing the aliquot can allow the sperm to begin to settle, altering the population of spermatozoa delivered to the slide.



6. Mix the sample well in the centrifuge tube by aspirating it 10 times into a wide-bore (approximately 1.5 mm diameter) pipette equilibrated to the temperature of the sample. This process should be vigorous enough to mix the semen, yet not so vigorous that it creates bubbles.
7. Immediately after mixing, without allowing time for the spermatozoa to settle out of suspension, place 10 µl of semen on the clear end of one of the cleaned slides. It is important not to let the drop of semen remain on the slide for more than a couple of seconds before smearing.
8. Smear the aliquot of semen over the surface of the slide using the feathering technique (**Section 2.4.9.1 on page 43**). In this procedure, the edge of a second slide is used to drag the drop of semen along the surface of the slide. Be sure to use the slide to “pull” the semen across the slide; do not use the slide to “push” the semen from behind. Care must be taken not to make the smears too thick, or there will be overlapping or clumped spermatozoa and more background stain. The separation of the spermatozoa on the slide depends on the volume of semen and the sperm concentration, the angle of the dragging slide (the smaller the angle, the thinner the smear) (435) and the speed of smearing (the more rapid the movement, the thicker the smear) (436).
9. Repeat steps 6–8 for the remaining slides, making only one slide after each mixing to ensure that the spermatozoa do not settle before the aliquot is removed. If there is a pause of more than a couple of seconds after mixing, the semen should be remixed before the aliquot is removed.
10. Once the technique is established and the preparation is going smoothly, it may be possible to make two or three slides after each mixing. The aliquots should all be removed immediately after mixing, and the two or three smears made as quickly as possible, and in any case within a few seconds.

### 8.6.5 Calibration of equipment

Pipettes, counting chambers and other equipment should be calibrated every 6 months or yearly.

#### 8.6.5.1 Balances

- Balances should be checked regularly with internal calibrators, and by external calibration at the time of regular laboratory maintenance service.
- Calibrate balances by weighing external standard weights (e.g. 1, 2, 5 and 10 g to cover the range of semen weights).
- Repeat measurements 10 times and calculate the mean, SD and coefficient of variation (CV) ( $= 100 \times \text{SD}/\text{mean}$ ).
- Check the accuracy. Does the stipulated weight fall within 2 SD of the measured mean?



### 8.6.5.2 Pipettes

- Calibrate pipettes by aspirating purified water up to the graduation mark and dispensing into weighing boats, which are sitting on a pre-zeroed analytical balance.
- Calculate the anticipated volume from the weight of water pipetted, assuming a density of 1 g/ml.



**Note:** The density of water decreases with temperature (437). It is 0.9982 g/ml at 20 °C, 0.9956 g/ml at 30 °C and 0.9922 g/ml at 40 °C. For purposes of calibration, however, an assumed value of 1.0 g/ml is adequate.

- Repeat measurements 10 times and calculate the mean, SD and CV ( $= 100 \times \text{SD}/\text{mean}$ ).
- Check the accuracy. Does the stipulated volume fall within 2 SD of the measured mean?

### 8.6.5.3 Depths of chambers

- Measure the depth of counting chambers using the Vernier scale on the fine focus of a microscope. Focus first on the chamber grid and then on an ink mark on the underside of the coverslip. Measure the number of graduation marks between the two points.
- Repeat the measurement 10 times and calculate the mean, SD and CV ( $= 100 \times \text{SD}/\text{mean}$ ).
- Check the accuracy. Does the stipulated depth fall within 2 SD of the measured mean?

### 8.6.5.4 Incubators

- The temperature of incubators and warm stages should be checked with thermometers that are, in turn, regularly calibrated.
- CO<sub>2</sub> gas mixtures should be checked daily with the incubator readout, or by other gas analyser systems, weekly to monthly, and by gas sampling at the time of servicing.

### 8.6.5.5 pH paper

This should be calibrated against known pH standards.

### 8.6.5.6 Other equipment

Other laboratory equipment and reagents, such as pH meters, should also be checked against standards every 3–6 months.



## 8.7 National external quality control programmes for semen analysis

A number of scientific societies and organizations in the field of andrology around the globe provide support to build and maintain a valid EQC programme for semen analysis and can be contacted for further information. The support comes at various levels. Some organizations offer formalized programmes in collaboration with associated companies. These programmes provide training and material necessary to fulfil the legal requirements which exist in various countries. Usually, these courses and programmes are accredited in the respective countries or regions. Other organizations offer training in specific aspects of semen analysis or practical insights into specific procedures. The World Health Organization is not associated to any of these programmes.





## Chapter 9: References

1. Belsey M, Eliasson R, Gallegos AJ, Moghissi KS, Paulsen CA, Prasad AMN. Laboratory Manual for the Examination of Human Semen and Semen-Cervical Mucus Interaction. Singapore: Press Concern; 1980.
2. World Health Organization. WHO laboratory manual for the examination of human semen and semen-cervical mucus interactions. 2nd ed. Cambridge, UK: Cambridge University Press; 1987. 67 p.
3. World Health Organization. WHO laboratory manual for the examination of human semen and sperm-cervical mucus interactions. 3rd ed. Cambridge, UK: Cambridge University Press; 1992. 107 p.
4. World Health Organization. WHO laboratory manual for the examination of human semen and sperm-cervical mucus interactions. 4th ed. Cambridge, UK: Cambridge University Press; 1999. 128 p.
5. Campbell MJ, Lotti F, Baldi E, Schlatt S, Festin MP, Björndahl L et al. Distribution of Semen Examination Results 2020 - a follow up of data collated for the WHO semen analysis manual 2010. *Andrology*. 2021.
6. Björndahl L. What is normal semen quality? On the use and abuse of reference limits for the interpretation of semen analysis results. *Hum Fertil (Camb)*. 2011;14(3):179-86.
7. Jedrzejczak P, Taszarek-Hauke G, Hauke J, Pawelczyk L, Duleba AJ. Prediction of spontaneous conception based on semen parameters. *Int J Androl*. 2008;31(5):499-507.
8. Guzick DS, Overstreet JW, Factor-Litvak P, Brazil CK, Nakajima ST, Coutifaris C et al. Sperm morphology, motility, and concentration in fertile and infertile men. *N Engl J Med*. 2001;345(19):1388-93.
9. Barratt CLR, Björndahl L, De Jonge CJ, Lamb DJ, Osorio Martini F, McLachlan R et al. The diagnosis of male infertility: an analysis of the evidence to support the development of global WHO guidance-challenges and future research opportunities. *Hum Reprod Update*. 2017;23(6):660-80.
10. Wang C, Swerdloff RS. Limitations of semen analysis as a test of male fertility and anticipated needs from newer tests. *Fertil Steril*. 2014;102(6):1502-7.
11. Nieschlag E, Pock T, Hellenkemper B. External quality of semen analysis reveals low compliance with the WHO guidelines. *J Reproduktionsmed Endokrinol\_Online*. 2017;14(6):306-10.



12. Barratt CL, Björndahl L, Menkveld R, Mortimer D. ESHRE special interest group for andrology basic semen analysis course: a continued focus on accuracy, quality, efficiency and clinical relevance. *Hum Reprod.* 2011;26(12):3207-12.
13. Björndahl L, Kvist U. Sequence of ejaculation affects the spermatozoon as a carrier and its message. *Reprod Biomed Online.* 2003;7(4):440-8.
14. Weiske WH. Pregnancy caused by sperm from vasa efferentia. *Fertil Steril.* 1994;62(3):642-3.
15. Sobrero AJ, Macleod J. The immediate postcoital test. *Fertil Steril.* 1962;13:184-9.
16. Cooper TG, Barfield JP, Yeung CH. Changes in osmolality during liquefaction of human semen. *Int J Androl.* 2005;28(1):58-60.
17. Holmes E, Björndahl L, Kvist U. Post-ejaculatory increase in human semen osmolality in vitro. *Andrologia.* 2019:e13311.
18. Holmes E, Björndahl L, Kvist U. Possible factors influencing post-ejaculatory changes of the osmolality of human semen in vitro. *Andrologia.* 2019:e13443.
19. Zavos PM, Goodpasture JC. Clinical improvements of specific seminal deficiencies via intercourse with a seminal collection device versus masturbation. *Fertil Steril.* 1989;51(1):190-3.
20. Pound N, Javed MH, Ruberto C, Shaikh MA, Del Valle AP. Duration of sexual arousal predicts semen parameters for masturbatory ejaculates. *Physiology & behavior.* 2002;76(4-5):685-9.
21. Eliasson R. Basic semen analysis. In: Matson P, editor. *Current Topics in Andrology.* Perth: Ladybrook Publishing; 2003. p. 35-89.
22. Amann RP. Evaluating spermatogenesis using semen: the biology of emission tells why reporting total sperm per sample is important, and why reporting only number of sperm per milliliter is irrational. *J Androl.* 2009;30(6):623-5.
23. Ng KK, Donat R, Chan L, Lalak A, Di Pierro I, Handelsman DJ. Sperm output of older men. *Hum Reprod.* 2004;19(8):1811-5.
24. Cooper TG, Keck C, Oberdieck U, Nieschlag E. Effects of multiple ejaculations after extended periods of sexual abstinence on total, motile and normal sperm numbers, as well as accessory gland secretions, from healthy normal and oligozoospermic men. *Hum Reprod.* 1993;8(8):1251-8.
25. Fernandez JL, Muriel L, Goyanes V, Segrelles E, Gosalvez J, Enciso M et al. Simple determination of human sperm DNA fragmentation with an improved sperm chromatin dispersion test. *Fertil Steril.* 2005;84(4):833-42.
26. Tyler JP, Crockett NG, Driscoll GL. Studies of human seminal parameters with frequent ejaculation. I. Clinical characteristics. *Clin Reprod Fertil.* 1982;1(4):273-85.
27. Tyler JP, Crockett NG, Driscoll GL. Studies of human seminal parameters with frequent ejaculation II. Spermatozoal vitality and storage. *Clin Reprod Fertil.* 1982;1(4):287-93.

28. De Jonge C, LaFromboise M, Bosmans E, Ombelet W, Cox A, Nijs M. Influence of the abstinence period on human sperm quality. *Fertil Steril*. 2004;82(1):57-65.
29. Correa-Perez JR. Intrasubject abstinence and quality of sperm. *Fertil Steril*. 2005;83(5):1588-9; author reply 9-90.
30. Amann RP, Howards SS. Daily spermatozoal production and epididymal spermatozoal reserves of the human male. *J Urol*. 1980;124(2):211-5.
31. Amann RP. Considerations in evaluating human spermatogenesis on the basis of total sperm per ejaculate. *J Androl*. 2009;30(6):626-41.
32. Handelsman DJ, Conway AJ, Boylan LM, Turtle JR. Testicular function in potential sperm donors: normal ranges and the effects of smoking and varicocele. *Int J Androl*. 1984;7(5):369-82.
33. Behre HM, Bergmann M, Simoni M, Tuttelmann F. Primary Testicular Failure. In: De Groot LJ, Chrousos G, Dungan K, Feingold KR, Grossman A, Hershman JM, et al., editors. *Endotext*. South Dartmouth (MA)2000.
34. Andersen AG, Jensen TK, Carlsen E, Jorgensen N, Andersson AM, Krarup T et al. High frequency of sub-optimal semen quality in an unselected population of young men. *Hum Reprod*. 2000;15(2):366-72.
35. Holstein AF, Schulze W, Davidoff M. Understanding spermatogenesis is a prerequisite for treatment. *Reprod Biol Endocrinol*. 2003;1:107.
36. Santi D, Corona G. Primary and Secondary Hypogonadism. In: Simoni M, Huhtaniemi I, editors. *Endocrinology of the Testis and Male Reproduction*. 2. London: Springer International Publishing; 2017. p. 687-747.
37. Medina P, Segarra G, Ballester R, Chuan P, Domenech C, Vila JM et al. Effects of antidepressants in adrenergic neurotransmission of human vas deferens. *Urology*. 2000;55(4):592-7.
38. Baker HW, Kovacs GT. Spontaneous improvement in semen quality: regression towards the mean. *Int J Androl*. 1985;8(6):421-6.
39. Alvarez C, Castilla JA, Martinez L, Ramirez JP, Vergara F, Gaforio JJ. Biological variation of seminal parameters in healthy subjects. *Hum Reprod*. 2003;18(10):2082-8.
40. Poland ML, Moghissi KS, Giblin PT, Ager JW, Olson JM. Variation of semen measures within normal men. *Fertil Steril*. 1985;44(3):396-400.
41. Berman NG, Wang C, Paulsen CA. Methodological issues in the analysis of human sperm concentration data. *J Androl*. 1996;17(1):68-73.
42. Carlsen E, Petersen JH, Andersson AM, Skakkebaek NE. Effects of ejaculatory frequency and season on variations in semen quality. *Fertil Steril*. 2004;82(2):358-66.
43. Castilla JA, Alvarez C, Aguilar J, Gonzalez-Varea C, Gonzalvo MC, Martinez L. Influence of analytical and biological variation on the clinical interpretation of seminal parameters. *Hum Reprod*. 2006;21(4):847-51.

44. Keel BA. Within- and between-subject variation in semen parameters in infertile men and normal semen donors. *Fertil Steril*. 2006;85(1):128-34.
45. Mortimer D. *Practical Laboratory Andrology*. Oxford: Oxford University Press; 1994. 393 p.
46. Mortimer D. Laboratory standards in routine clinical andrology. *Reproductive Medicine Review*. 1994;3:97-111.
47. Jones DM, Kovacs GT, Harrison L, Jennings MG, Baker HW. Immobilization of sperm by condoms and their components. *Clin Reprod Fertil*. 1986;4(6):367-72.
48. World Health Organization. *Laboratory biosafety manual*, 3rd edition. Geneva 2004.
49. Huggins C, Scott WW, Heinen JH. Chemical composition of human semen and of the secretions of the prostate and seminal vesicles. *Am J Physiol*. 1942;136(3):467-73.
50. Brazil C, Swan SH, Drobnis EZ, Liu F, Wang C, Redmon JB et al. Standardized methods for semen evaluation in a multicenter research study. *J Androl*. 2004;25(4):635-44.
51. Cooper TG, Brazil C, Swan SH, Overstreet JW. Ejaculate volume is seriously underestimated when semen is pipetted or decanted into cylinders from the collection vessel. *J Androl*. 2007;28(1):1-4.
52. Rose NR, Hjort T, Rümke P, Harper MJK, Vyazov O. Techniques for detection of iso- and auto-antibodies to human spermatozoa. *Clin Exp Immunol*. 1976;23(2):175-99.
53. Johansson E, Campana A, Luthi R, de Agostini A. Evaluation of 'round cells' in semen analysis: a comparative study. *Hum Reprod Update*. 2000;6(4):404-12.
54. Freund M. Standards for the rating of human sperm morphology. A cooperative study. *Int J Fertil*. 1966;11(1):97-180.
55. Jue JS, Ramasamy R. Significance of positive semen culture in relation to male infertility and the assisted reproductive technology process. *Transl Androl Urol*. 2017;6(5):916-22.
56. Micillo A, Vassallo MR, Cordeschi G, D'Andrea S, Necozone S, Francavilla F et al. Semen leukocytes and oxidative-dependent DNA damage of spermatozoa in male partners of subfertile couples with no symptoms of genital tract infection. *Andrology*. 2016;4(5):808-15.
57. Palermo GD, Neri QV, Cozzubbo T, Cheung S, Pereira N, Rosenwaks Z. Shedding Light on the Nature of Seminal Round Cells. *PLoS One*. 2016;11(3):e0151640.
58. Jouannet P, Ducot B, Feneux D, Spira A. Male factors and the likelihood of pregnancy in infertile couples. I. Study of sperm characteristics. *Int J Androl*. 1988;11(5):379-94.



59. Zinaman MJ, Brown CC, Selevan SG, Clegg ED. Semen quality and human fertility: a prospective study with healthy couples. *J Androl.* 2000;21(1):145-53.
60. Larsen L, Scheike T, Jensen TK, Bonde JP, Ernst E, Hjollund NH et al. Computer-assisted semen analysis parameters as predictors for fertility of men from the general population. The Danish First Pregnancy Planner Study Team. *Hum Reprod.* 2000;15(7):1562-7.
61. Aitken RJ, Sutton M, Warner P, Richardson DW. Relationship between the movement characteristics of human spermatozoa and their ability to penetrate cervical mucus and zona-free hamster oocytes. *J Reprod Fertil.* 1985;73(2):441-9.
62. Mortimer D, Pandya IJ, Sawers RS. Relationship between human sperm motility characteristics and sperm penetration into human cervical mucus in vitro. *J Reprod Fertil.* 1986;78(1):93-102.
63. Comhaire FH, Vermeulen L, Hinting A, Schoonjans F. Accuracy of sperm characteristics in predicting the in vitro fertilizing capacity of semen. *J In Vitro Fert Embryo Transf.* 1988;5(6):326-31.
64. Barratt CL, McLeod ID, Dunphy BC, Cooke ID. Prognostic value of two putative sperm function tests: hypo-osmotic swelling and bovine sperm mucus penetration test (Penetrak). *Hum Reprod.* 1992;7(9):1240-4.
65. Irvine DS, Aitken RJ. Predictive value of in-vitro sperm function tests in the context of an AID service. *Hum Reprod.* 1986;1(8):539-45.
66. Bollendorf A, Check JH, Lurie D. Evaluation of the effect of the absence of sperm with rapid and linear progressive motility on subsequent pregnancy rates following intrauterine insemination or in vitro fertilization. *J Androl.* 1996;17(5):550-7.
67. Sifer C, Sasportes T, Barraud V, Poncelet C, Rudant J, Porcher R et al. World Health Organization grade 'a' motility and zona-binding test accurately predict IVF outcome for mild male factor and unexplained infertilities. *Hum Reprod.* 2005;20(10):2769-75.
68. Van den Bergh M, Emiliani S, Biramane J, Vannin AS, Englert Y. A first prospective study of the individual straight line velocity of the spermatozoon and its influences on the fertilization rate after intracytoplasmic sperm injection. *Hum Reprod.* 1998;13(11):3103-7.
69. Björndahl L. The usefulness and significance of assessing rapidly progressive spermatozoa. *Asian J Androl.* 2010;12(1):33-5.
70. Eliasson R. Semen analysis with regard to sperm number, sperm morphology and functional aspects. *Asian J Androl.* 2010;12(1):26-32.
71. Afzelius BA, Eliasson R, Johnsen O, Lindholmer C. Lack of dynein arms in immotile human spermatozoa. *J Cell Biol.* 1975;66(2):225-32.
72. Chemes EH, Rawe YV. Sperm pathology: a step beyond descriptive morphology. Origin, characterization and fertility potential of abnormal sperm phenotypes in infertile men. *Hum Reprod Update.* 2003;9(5):405-28.

73. Wilton LJ, Temple-Smith PD, Baker HW, de Kretser DM. Human male infertility caused by degeneration and death of sperm in the epididymis. *Fertil Steril.* 1988;49(6):1052-8.
74. Correa-Perez JR, Fernandez-Pelegri R, Aslanis P, Zavos PM. Clinical management of men producing ejaculates characterized by high levels of dead sperm and altered seminal plasma factors consistent with epididymal necropermia. *Fertil Steril.* 2004;81(4):1148-50.
75. Björndahl L, Soderlund I, Johansson S, Mohammadieh M, Pourian MR, Kvist U. Why the WHO recommendations for eosin-nigrosin staining techniques for human sperm vitality assessment must change. *J Androl.* 2004;25(5):671-8.
76. Björndahl L, Soderlund I, Kvist U. Evaluation of the one-step eosin-nigrosin staining technique for human sperm vitality assessment. *Hum Reprod.* 2003;18(4):813-6.
77. Mortimer D. A technical note on the assessment of human sperm vitality using eosin-nigrosin staining. *Reprod Biomed Online.* 2020;40(6):851-5.
78. Slama R, Eustache F, Ducot B, Jensen TK, Jorgensen N, Horte A et al. Time to pregnancy and semen parameters: a cross-sectional study among fertile couples from four European cities. *Hum Reprod.* 2002;17(2):503-15.
79. World Health Organization. Task Force on Methods for the Regulation of Male Fertility: Contraceptive efficacy of testosterone-induced azoospermia and oligozoospermia in normal men. *Fertil Steril.* 1996;65(4):821-9.
80. Bonde JP, Ernst E, Jensen TK, Hjollund NH, Kolstad H, Henriksen TB et al. Relation between semen quality and fertility: a population-based study of 430 first-pregnancy planners. *Lancet.* 1998;352(9135):1172-7.
81. Behre HM, Yeung CH, Holstein AF, Weinbauer GF, Gassner C, Nieschlag E. Diagnosis of Male Infertility and Hypogonadism. In: Nieschlag E, Behre HM, editors. *Andrology: Male Reproductive Health and Dysfunction.* second ed. Berlin Heidelberg New York: Springer Verlag; 2000. p. 90-121.
82. MacLeod J, Wang Y. Male fertility potential in terms of semen quality: a review of the past, a study of the present. *Fertil Steril.* 1979;31(2):103-16.
83. Eliasson R. Analysis of semen. In: Behrman SJ, Kistner RW, editors. *Progress in Infertility.* Boston: Little, Brown and Co; 1975. p. 691-713.
84. Björndahl L, Mortimer D, Barratt CLR, Castilla JA, Menkveld R, Kvist U et al. *A Practical Guide to Basic Laboratory Andrology.* Cambridge: Cambridge University Press; 2010.
85. Mortimer D, Shu MA, Tan R. Standardization and quality control of sperm concentration and sperm motility counts in semen analysis. *Human reproduction (Oxford, England).* 1986;1(5):299-303.
86. Kirkman-Brown J, Björndahl L. Evaluation of a disposable plastic Neubauer counting chamber for semen analysis. *Fertil Steril.* 2009;91(2):627-31.

87. Cooper TG, Hellenkemper B, Jonckheere J, Callewaert N, Grootenhuis AJ, Kersemaekers WM et al. Azoospermia: virtual reality or possible to quantify? *J Androl.* 2006;27(4):483-90.
88. Ezeh UI, Moore HM. Redefining azoospermia and its implications. *Fertil Steril.* 2001;75(1):213-4.
89. Sharif K. Reclassification of azoospermia: the time has come? *Hum Reprod.* 2000;15(2):237-8.
90. Eliasson R. Analysis of semen. In: Burger HG, De Kretser DM, editors. *The Testis.* New York: Raven Press; 1981. p. 381-99.
91. Lindsay KS, Floyd I, Swan R. Classification of azoospermic samples. *Lancet.* 1995;345(8965):1642.
92. Jaffe TM, Kim ED, Hoekstra TH, Lipshultz LI. Sperm pellet analysis: a technique to detect the presence of sperm in men considered to have azoospermia by routine semen analysis. *J Urol.* 1998;159(5):1548-50.
93. Corea M, Campagnone J, Sigman M. The diagnosis of azoospermia depends on the force of centrifugation. *Fertil Steril.* 2005;83(4):920-2.
94. Fredricsson B, Bjork G. Morphology of postcoital spermatozoa in the cervical secretion and its clinical significance. *Fertil Steril.* 1977;28(8):841-5.
95. Menkveld R, Stander FS, Kotze TJ, Kruger TF, van Zyl JA. The evaluation of morphological characteristics of human spermatozoa according to stricter criteria. *Hum Reprod.* 1990;5(5):586-92.
96. Menkveld R, Franken DR, Kruger TF, Oehninger S, Hodgen GD. Sperm selection capacity of the human zona pellucida. *Mol Reprod Dev.* 1991;30(4):346-52.
97. Liu DY, Baker HW. Morphology of spermatozoa bound to the zona pellucida of human oocytes that failed to fertilize in vitro. *J Reprod Fertil.* 1992;94(1):71-84.
98. Eggert-Kruse W, Schwarz H, Rohr G, Demirakca T, Tilgen W, Runnebaum B. Sperm morphology assessment using strict criteria and male fertility under in-vivo conditions of conception. *Hum Reprod.* 1996;11(1):139-46.
99. Coetzee K, Kruger TF, Lombard CJ. Predictive value of normal sperm morphology: a structured literature review. *Hum Reprod Update.* 1998;4(1):73-82.
100. Toner JP, Mossad H, Grow DR, Morshedi M, Swanson RJ, Oehninger S. Value of sperm morphology assessed by strict criteria for prediction of the outcome of artificial (intrauterine) insemination. *Andrologia.* 1995;27(3):143-8.
101. Van Waart J, Kruger TF, Lombard CJ, Ombelet W. Predictive value of normal sperm morphology in intrauterine insemination (IUI): a structured literature review. *Hum Reprod Update.* 2001;7(5):495-500.
102. Garrett C, Liu DY, Clarke GN, Rushford DD, Baker HW. Automated semen analysis: 'zona pellucida preferred' sperm morphometry and straight-line velocity are related to pregnancy rate in subfertile couples. *Hum Reprod.* 2003;18(8):1643-9.

103. Liu DY, Garrett C, Baker HW. Low proportions of sperm can bind to the zona pellucida of human oocytes. *Hum Reprod.* 2003;18(11):2382-9.
104. Menkveld R, Wong WY, Lombard CJ, Wetzels AM, Thomas CM, Merkus HM et al. Semen parameters, including WHO and strict criteria morphology, in a fertile and subfertile population: an effort towards standardization of in-vivo thresholds. *Hum Reprod.* 2001;16(6):1165-71.
105. van der Merwe FH, Kruger TF, Oehninger SC, Lombard CJ. The use of semen parameters to identify the subfertile male in the general population. *Gynecol Obstet Invest.* 2005;59(2):86-91.
106. Mortimer D. The functional anatomy of the human spermatozoon: relating ultrastructure and function. *Mol Hum Reprod.* 2018;24(12):567-92.
107. Katz DF, Overstreet JW, Samuels SJ, Niswander PW, Bloom TD, Lewis EL. Morphometric analysis of spermatozoa in the assessment of human male fertility. *J Androl.* 1986;7(4):203-10.
108. Abraham-Peskir JV, Chantler E, Uggerhoj E, Fedder J. Response of midpiece vesicles on human sperm to osmotic stress. *Hum Reprod.* 2002;17(2):375-82.
109. Cooper TG, Yeung CH, Fetic S, Sobhani A, Nieschlag E. Cytoplasmic droplets are normal structures of human sperm but are not well preserved by routine procedures for assessing sperm morphology. *Hum Reprod.* 2004;19(10):2283-8.
110. Kruger TF, Acosta AA, Simmons KF, Swanson RJ, Matta JF, Oehninger S. Predictive value of abnormal sperm morphology in in vitro fertilization. *Fertil Steril.* 1988;49(1):112-7.
111. Zollner U, Schleyer M, Steck T. Evaluation of a cut-off value for normal sperm morphology using strict criteria to predict fertilization after conventional in-vitro fertilization and embryo transfer in asthenozoospermia. *Hum Reprod.* 1996;11(10):2155-61.
112. Franken DR, Barendsen R, Kruger TF. A continuous quality control program for strict sperm morphology. *Fertil Steril.* 2000;74(4):721-4.
113. Menkveld R, El-Garem Y, Schill WB, Henkel R. Relationship between human sperm morphology and acrosomal function. *J Assist Reprod Genet.* 2003;20(10):432-8.
114. Kvist U, Björndahl L. *Manual on Basic Semen Analysis 2002.* Heineman MJ, editor. Oxford: Oxford Academic; 2002 2002-06-15. 24 p.
115. Kruger TF, Menkveld R, Stander FS, Lombard CJ, Van der Merwe JP, van Zyl JA et al. Sperm morphologic features as a prognostic factor in in vitro fertilization. *Fertil Steril.* 1986;46(6):1118-23.
116. Inaba K, Mizuno K. Sperm dysfunction and ciliopathy. *Reprod Med Biol.* 2016;15(2):77-94.
117. Gandini L, Lombardo F, Paoli D, Caponecchia L, Familiari G, Verlengia C et al. Study of apoptotic DNA fragmentation in human spermatozoa. *Hum Reprod.* 2000;15(4):830-9.

118. Lee JD, Kamiguchi Y, Yanagimachi R. Analysis of chromosome constitution of human spermatozoa with normal and aberrant head morphologies after injection into mouse oocytes. *Hum Reprod.* 1996;11(9):1942-6.
119. Dadoune JP, Mayaux MJ, Guihard-Moscato ML. Correlation between defects in chromatin condensation of human spermatozoa stained by aniline blue and semen characteristics. *Andrologia.* 1988;20(3):211-7.
120. Devillard F, Metzler-Guillemain C, Pelletier R, DeRobertis C, Bergues U, Hennebicq S et al. Polyploidy in large-headed sperm: FISH study of three cases. *Hum Reprod.* 2002;17(5):1292-8.
121. Martin RH, Rademaker AW, Greene C, Ko E, Hoang T, Barclay L et al. A comparison of the frequency of sperm chromosome abnormalities in men with mild, moderate, and severe oligozoospermia. *Biol Reprod.* 2003;69(2):535-9.
122. Mortimer D, Menkveld R. Sperm morphology assessment--historical perspectives and current opinions. *J Androl.* 2001;22(2):192-205.
123. Chantler E, Abraham-Peskir JV. Significance of midpiece vesicles and functional integrity of the membranes of human spermatozoa after osmotic stress. *Andrologia.* 2004;36(2):87-93.
124. Fetic S, Yeung CH, Sonntag B, Nieschlag E, Cooper TG. Relationship of cytoplasmic droplets to motility, migration in mucus, and volume regulation of human spermatozoa. *J Androl.* 2006;27(2):294-301.
125. Pelfrey RJ, Overstreet JW, Lewis EL. Abnormalities of sperm morphology in cases of persistent infertility after vasectomy reversal. *Fertil Steril.* 1982;38(1):112-4.
126. Rothmann SA, Bort AM, Quigley J, Pillow R. Sperm morphology classification: a rational method for schemes adopted by the world health organization. *Methods Mol Biol.* 2013;927:27-37.
127. Iwamoto T, Nozawa S, Yoshiike M, Hoshino T, Baba K, Matsushita T et al. Semen quality of 324 fertile Japanese men. *Hum Reprod.* 2006;21(3):760-5.
128. de la Taille A, Rigot JM, Mahe P, Gervais R, Dumur V, Lemaitre L et al. [Correlation of genitourinary abnormalities, spermiogram and CFTR genotype in patients with bilateral agenesis of the vas deferens]. *Prog Urol.* 1998;8(3):370-6.
129. Weiske WH, Salzler N, Schroeder-Printzen I, Weidner W. Clinical findings in congenital absence of the vasa deferentia. *Andrologia.* 2000;32(1):13-8.
130. Daudin M, Bieth E, Bujan L, Massat G, Pontonnier F, Mieuxset R. Congenital bilateral absence of the vas deferens: clinical characteristics, biological parameters, cystic fibrosis transmembrane conductance regulator gene mutations, and implications for genetic counseling. *Fertil Steril.* 2000;74(6):1164-74.
131. von Eckardstein S, Cooper TG, Rutscha K, Meschede D, Horst J, Nieschlag E. Seminal plasma characteristics as indicators of cystic fibrosis transmembrane conductance regulator (CFTR) gene mutations in men with obstructive azoospermia. *Fertil Steril.* 2000;73(6):1226-31.

132. Kussler AP, Pimentel AM, Alcoba DD, Liu IP, Brum IS, Capp E et al. Mechanical processing of hyperviscous semen specimens can negatively affect sperm DNA fragmentation. *Int Urol Nephrol.* 2014;46(4):737-42.
133. de la Taille A, Rigot JM, Mahe P, Vankemmel O, Gervais R, Dumur V et al. Correlation between genito-urinary anomalies, semen analysis and CFTR genotype in patients with congenital bilateral absence of the vas deferens. *Br J Urol.* 1998;81(4):614-9.
134. Haugen TB, Grotmol T. pH of human semen. *Int J Androl.* 1998;21(2):105-8.
135. Le Lannou D, Griveau JF, Le Pichon JP, Quero JC. Effects of chamber depth on the motion pattern of human spermatozoa in semen or in capacitating medium. *Hum Reprod.* 1992;7(10):1417-21.
136. Kraemer M, Fillion C, Martin-Pont B, Auger J. Factors influencing human sperm kinematic measurements by the Celltrak computer-assisted sperm analysis system. *Hum Reprod.* 1998;13(3):611-9.
137. Motulsky H. *Intuitive biostatistics.* New York: Oxford University Press; 1995.
138. Seaman EK, Goluboff E, BarChama N, Fisch H. Accuracy of semen counting chambers as determined by the use of latex beads. *Fertil Steril.* 1996;66(4):662-5.
139. Mahmoud AM, Depoorter B, Piens N, Comhaire FH. The performance of 10 different methods for the estimation of sperm concentration. *Fertil Steril.* 1997;68(2):340-5.
140. Björndahl L, Magnusson K, Holmberg R. Validation of Cellvision Disposable 100 Micrometer Hemocytometer With Improved Neubauer Ruling. *Andrology.* 2018;6(S1).
141. Brazil C, Swan SH, Tollner CR, Treece C, Drobnis EZ, Wang C et al. Quality control of laboratory methods for semen evaluation in a multicenter research study. *J Androl.* 2004;25(4):645-56.
142. Douglas-Hamilton DH, Smith NG, Kuster CE, Vermeiden JP, Althouse GC. Capillary-loaded particle fluid dynamics: effect on estimation of sperm concentration. *J Androl.* 2005;26(1):115-22.
143. Douglas-Hamilton DH, Smith NG, Kuster CE, Vermeiden JP, Althouse GC. Particle distribution in low-volume capillary-loaded chambers. *J Androl.* 2005;26(1):107-14.
144. Björndahl L, Barratt CL. Semen analysis: setting standards for the measurement of sperm numbers. *J Androl.* 2005;26(1):11.
145. Jeyendran RS, Van der Ven HH, Perez-Pelaez M, Crabo BG, Zaneveld LJ. Development of an assay to assess the functional integrity of the human sperm membrane and its relationship to other semen characteristics. *J Reprod Fertil.* 1984;70(1):219-28.

146. Hossain AM, Rizk B, Barik S, Huff C, Thorneycroft IH. Time course of hypo-osmotic swellings of human spermatozoa: evidence of ordered transition between swelling subtypes. *Hum Reprod.* 1998;13(6):1578-83.
147. Holmes E. On osmolality and sperm function during processing for assisted reproduction [Academic]. Stockholm, Sweden: Karolinska Institutet; 2020.
148. Meschede D, Keck C, Zander M, Cooper TG, Yeung CH, Nieschlag E. Influence of three different preparation techniques on the results of human sperm morphology analysis. *Int J Androl.* 1993;16(6):362-9.
149. Kruger TF, Ackerman SB, Simmons KF, Swanson RJ, Brugo SS, Acosta AA. A quick, reliable staining technique for human sperm morphology. *Arch Androl.* 1987;18(3):275-7.
150. Coetzee K, Kruger TF, Vandendael A, de Villiers A, Lombard CJ. Comparison of two staining and evaluation methods used for computerized human sperm morphology evaluations. *Andrologia.* 1997;29(3):133-5.
151. Oral E, Yetis O, Elibol F, Senol H, Irez T, Aksu FM. Assessment of human sperm morphology by strict criteria: comparison of wet preparation versus stained with the modified Diff-Quik method. *Arch Androl.* 2002;48(4):307-14.
152. Maree L, du Plessis SS, Menkveld R, van der Horst G. Morphometric dimensions of the human sperm head depend on the staining method used. *Hum Reprod.* 2010;25(6):1369-82.
153. Auger J, Eustache F, Andersen AG, Irvine DS, Jorgensen N, Skakkebaek NE et al. Sperm morphological defects related to environment, lifestyle and medical history of 1001 male partners of pregnant women from four European cities. *Hum Reprod.* 2001;16(12):2710-7.
154. Menkveld RK, T.F. Basic Semen Analysis. In: Acosta AA, editor. Human spermatozoa in assisted reproduction. Baltimore: Williams & Wilkins; 1990. p. 68-84.
155. Aziz N, Buchan I, Taylor C, Kingsland CR, Lewis-Jones I. The sperm deformity index: a reliable predictor of the outcome of oocyte fertilization in vitro. *Fertil Steril.* 1996;66(6):1000-8.
156. Aziz N, Agarwal A, Lewis-Jones I, Sharma RK, Thomas AJ, Jr. Novel associations between specific sperm morphological defects and leukocytospermia. *Fertil Steril.* 2004;82(3):621-7.
157. Aziz N, Saleh RA, Sharma RK, Lewis-Jones I, Esfandiari N, Thomas AJ, Jr. et al. Novel association between sperm reactive oxygen species production, sperm morphological defects, and the sperm deformity index. *Fertil Steril.* 2004;81(2):349-54.
158. David G, Czyglik F, Mayaux MJ, Schwartz D. The success of A.I.D. and semen characteristics: study on 1489 cycles and 192 ejaculates. *Int J Androl.* 1980;3(6):613-9.
159. Auger JE, F. Standardisation de la classification morphologique des spermatozoïdes humains selon la méthode de David modifiée. *Andrologia.* 2000;10:358-73.

160. ESHRE/NAFA. Manual on basic semen analysis (ESHRE Monographs #2). Oxford: Oxford University Press; 2002.
161. Wang WL, Tu CF, Tan YQ. Insight on multiple morphological abnormalities of sperm flagella in male infertility: what is new? *Asian J Androl.* 2020;22(3):236-45.
162. Coutton C, Escoffier J, Martinez G, Arnoult C, Ray PF. Teratozoospermia: spotlight on the main genetic actors in the human. *Hum Reprod Update.* 2015;21(4):455-85.
163. Jørgensen N, Andersen AG, Eustache F, Irvine DS, Suominen J, Petersen JH et al. Regional differences in semen quality in Europe. *Hum Reprod.* 2001;16(5):1012-9.
164. Muratori M, Marchiani S, Tamburrino L, Cambi M, Lotti F, Natali I et al. DNA fragmentation in brighter sperm predicts male fertility independently from age and semen parameters. *Fertil Steril.* 2015;104(3):582-90 e4.
165. Muratori M, Marchiani S, Tamburrino L, Baldi E. Sperm DNA Fragmentation: Mechanisms of Origin. *Adv Exp Med Biol.* 2019;1166:75-85.
166. Sakkas D, Alvarez JG. Sperm DNA fragmentation: mechanisms of origin, impact on reproductive outcome, and analysis. *Fertil Steril.* 2010;93(4):1027-36.
167. Robinson L, Gallos ID, Conner SJ, Rajkhowa M, Miller D, Lewis S et al. The effect of sperm DNA fragmentation on miscarriage rates: a systematic review and meta-analysis. *Hum Reprod.* 2012;27(10):2908-17.
168. Cissen M, Wely MV, Scholten I, Mansell S, Bruin JP, Mol BW et al. Measuring Sperm DNA Fragmentation and Clinical Outcomes of Medically Assisted Reproduction: A Systematic Review and Meta-Analysis. *PLoS One.* 2016;11(11):e0165125.
169. Simon L, Zini A, Dyachenko A, Ciampi A, Carrell DT. A systematic review and meta-analysis to determine the effect of sperm DNA damage on in vitro fertilization and intracytoplasmic sperm injection outcome. *Asian J Androl.* 2017;19(1):80-90.
170. Tan J, Taskin O, Albert A, Bedaiwy MA. Association between sperm DNA fragmentation and idiopathic recurrent pregnancy loss: a systematic review and meta-analysis. *Reprod Biomed Online.* 2019;38(6):951-60.
171. Evgeni E, Charalabopoulos K, Asimakopoulos B. Human sperm DNA fragmentation and its correlation with conventional semen parameters. *J Reprod Infertil.* 2014;15(1):2-14.
172. Robbins DJ, Coleman MS. Initiator role of double stranded DNA in terminal transferase catalyzed polymerization reactions. *Nucleic Acids Res.* 1988;16(7):2943-57.
173. Sharma R, Masaki J, Agarwal A. Sperm DNA fragmentation analysis using the TUNEL assay. *Methods Mol Biol.* 2013;927:121-36.
174. Muratori M, Tamburrino L, Tocci V, Costantino A, Marchiani S, Giachini C et al. Small variations in crucial steps of TUNEL assay coupled to flow cytometry greatly affect measures of sperm DNA fragmentation. *J Androl.* 2010;31(4):336-45.



175. Muratori M, Tamburrino L, Marchiani S, Guido C, Forti G, Baldi E. Critical aspects of detection of sperm DNA fragmentation by TUNEL/flow cytometry. *Syst Biol Reprod Med*. 2010;56(4):277-85.
176. Darzynkiewicz Z, Galkowski D, Zhao H. Analysis of apoptosis by cytometry using TUNEL assay. *Methods*. 2008;44(3):250-4.
177. Dominguez-Fandos D, Camejo MI, Balleca JL, Oliva R. Human sperm DNA fragmentation: correlation of TUNEL results as assessed by flow cytometry and optical microscopy. *Cytometry A*. 2007;71(12):1011-8.
178. Sergerie M, Laforest G, Bujan L, Bissonnette F, Bleau G. Sperm DNA fragmentation: threshold value in male fertility. *Hum Reprod*. 2005;20(12):3446-51.
179. Sergerie M, Laforest G, Boulanger K, Bissonnette F, Bleau G. Longitudinal study of sperm DNA fragmentation as measured by terminal uridine nick end-labelling assay. *Hum Reprod*. 2005;20(7):1921-7.
180. Antonucci N, Manes S, Corradetti B, Manicardi GC, Borini A, Bizzaro D. A novel in vitro sperm head decondensation protocol for rapid flow cytometric measurement of deoxyribonucleic acid content. *Fertil Steril*. 2013;99(7):1857-61.
181. Mitchell LA, De luliis GN, Aitken RJ. The TUNEL assay consistently underestimates DNA damage in human spermatozoa and is influenced by DNA compaction and cell vitality: development of an improved methodology. *Int J Androl*. 2011;34(1):2-13.
182. Ribeiro SC, Muratori M, De Geyter M, De Geyter C. TUNEL labeling with BrdUTP/anti-BrdUTP greatly underestimates the level of sperm DNA fragmentation in semen evaluation. *PLoS One*. 2017;12(8):e0181802.
183. Muratori M, Pellegrino G, Mangone G, Azzari C, Lotti F, Tarozzi N et al. DNA Fragmentation in Viable and Non-Viable Spermatozoa Discriminates Fertile and Subfertile Subjects with Similar Accuracy. *J Clin Med*. 2020;9(5).
184. Martinez MG, Sanchez-Martin P, Dorado-Silva M, Fernandez JL, Girones E, Johnston SD et al. Magnetic-activated cell sorting is not completely effective at reducing sperm DNA fragmentation. *J Assist Reprod Genet*. 2018;35(12):2215-21.
185. Fernandez JL, Cajigal D, Lopez-Fernandez C, Gosalvez J. Assessing sperm DNA fragmentation with the sperm chromatin dispersion test. *Methods Mol Biol*. 2011;682:291-301.
186. Fernandez JL, Muriel L, Rivero MT, Goyanes V, Vazquez R, Alvarez JG. The sperm chromatin dispersion test: a simple method for the determination of sperm DNA fragmentation. *J Androl*. 2003;24(1):59-66.
187. Gosalvez J, Rodriguez-Predreira M, Mosquera A, Lopez-Fernandez C, Esteves SC, Agarwal A et al. Characterisation of a subpopulation of sperm with massive nuclear damage, as recognised with the sperm chromatin dispersion test. *Andrologia*. 2014;46(6):602-9.
188. Klaude M, Eriksson S, Nygren J, Ahnstrom G. The comet assay: mechanisms and technical considerations. *Mutat Res*. 1996;363(2):89-96.

189. McKelvey-Martin VJ, Melia N, Walsh IK, Johnston SR, Hughes CM, Lewis SE et al. Two potential clinical applications of the alkaline single-cell gel electrophoresis assay: (1). Human bladder washings and transitional cell carcinoma of the bladder; and (2). Human sperm and male infertility. *Mutat Res.* 1997;375(2):93-104.
190. Simon L, Carrell DT. Sperm DNA damage measured by comet assay. *Methods Mol Biol.* 2013;927:137-46.
191. Baumgartner A, Cemeli E, Anderson D. The comet assay in male reproductive toxicology. *Cell Biol Toxicol.* 2009;25(1):81-98.
192. Collins AR, Dobson VL, Dusinska M, Kennedy G, Stetina R. The comet assay: what can it really tell us? *Mutat Res.* 1997;375(2):183-93.
193. Konca K, Lankoff A, Banasik A, Lisowska H, Kuszewski T, Gozdz S et al. A cross-platform public domain PC image-analysis program for the comet assay. *Mutat Res.* 2003;534(1-2):15-20.
194. Gonzalez JE, Romero I, Barquinero JF, Garcia O. Automatic analysis of silver-stained comets by CellProfiler software. *Mutat Res.* 2012;748(1-2):60-4.
195. Simon L, Castillo J, Oliva R, Lewis SE. Relationships between human sperm protamines, DNA damage and assisted reproduction outcomes. *Reprod Biomed Online.* 2011;23(6):724-34.
196. Ribas-Maynou J, Garcia-Peiro A, Fernandez-Encinas A, Abad C, Amengual MJ, Prada E et al. Comprehensive analysis of sperm DNA fragmentation by five different assays: TUNEL assay, SCSA, SCD test and alkaline and neutral Comet assay. *Andrology.* 2013;1(5):715-22.
197. Javed A, Talkad MS, Ramaiah MK. Corrigendum to "Evaluation of sperm DNA fragmentation using multiple methods: a comparison of their predictive power for male infertility". *Clin Exp Reprod Med.* 2019;46(4):211.
198. Javed A, Talkad MS, Ramaiah MK. Evaluation of sperm DNA fragmentation using multiple methods: a comparison of their predictive power for male infertility. *Clin Exp Reprod Med.* 2019;46(1):14-21.
199. Evenson DP. Sperm chromatin structure assay (SCSA(R)). *Methods Mol Biol.* 2013;927:147-64.
200. Evenson D, Jost L. Sperm chromatin structure assay is useful for fertility assessment. *Methods Cell Sci.* 2000;22(2-3):169-89.
201. Evenson D, Jost L. Sperm chromatin structure assay for fertility assessment. *Curr Protoc Cytom.* 2001;Chapter 7:Unit 7 13.
202. Evenson DP, Jost LK, Marshall D, Zinaman MJ, Clegg E, Purvis K et al. Utility of the sperm chromatin structure assay as a diagnostic and prognostic tool in the human fertility clinic. *Hum Reprod.* 1999;14(4):1039-49.
203. Giwercman A, Lindstedt L, Larsson M, Bungum M, Spano M, Levine RJ et al. Sperm chromatin structure assay as an independent predictor of fertility in vivo: a case-control study. *Int J Androl.* 2010;33(1):e221-7.

204. Godo A, Blanco J, Vidal F, Sandalinas M, Garcia-Guixe E, Anton E. Altered segregation pattern and numerical chromosome abnormalities interrelate in spermatozoa from Robertsonian translocation carriers. *Reprod Biomed Online*. 2015;31(1):79-88.
205. Wang BN, B.; Tang, D.; Li, R.; Liu, X.; Song, J.; Wang, W.; Liu, Z. . Analysis of Meiotic Segregation Patterns and Interchromosomal Effects in Sperm from 13 Robertsonian Translocations. *Balkan J Med Genet* 2017;20(1):43-50.
206. Enciso M, Alfarawati S, Wells D. Increased numbers of DNA-damaged spermatozoa in samples presenting an elevated rate of numerical chromosome abnormalities. *Hum Reprod*. 2013;28(6):1707-15.
207. Ramasamy R, Scovell JM, Kovac JR, Cook PJ, Lamb DJ, Lipshultz LI. Fluorescence in situ hybridization detects increased sperm aneuploidy in men with recurrent pregnancy loss. *Fertil Steril*. 2015;103(4):906-9 e1.
208. Kohn TP, Kohn JR, Darilek S, Ramasamy R, Lipshultz L. Genetic counseling for men with recurrent pregnancy loss or recurrent implantation failure due to abnormal sperm chromosomal aneuploidy. *J Assist Reprod Genet*. 2016;33(5):571-6.
209. Ramasamy R, Besada S, Lamb DJ. Fluorescent in situ hybridization of human sperm: diagnostics, indications, and therapeutic implications. *Fertil Steril*. 2014;102(6):1534-9.
210. Ryu HM, Lin WW, Lamb DJ, Chuang W, Lipshultz LI, Bischoff FZ. Increased chromosome X, Y, and 18 nondisjunction in sperm from infertile patients that were identified as normal by strict morphology: implication for intracytoplasmic sperm injection. *Fertil Steril*. 2001;76(5):879-83.
211. Ioannou D, Fortun J, Tempest HG. Meiotic nondisjunction and sperm aneuploidy in humans. *Reproduction*. 2019;157(1):R15-R31.
212. Neusser M, Rogenhofer N, Durl S, Ochsenkuhn R, Trottmann M, Jurinovic V et al. Increased chromosome 16 disomy rates in human spermatozoa and recurrent spontaneous abortions. *Fertil Steril*. 2015;104(5):1130-7 e1-10.
213. Templado C, Uroz L, Estop A. New insights on the origin and relevance of aneuploidy in human spermatozoa. *Mol Hum Reprod*. 2013;19(10):634-43.
214. Tomlinson MJ, Barratt CL, Cooke ID. Prospective study of leukocytes and leukocyte subpopulations in semen suggests they are not a cause of male infertility. *Fertil Steril*. 1993;60(6):1069-75.
215. Wolff H. The biologic significance of white blood cells in semen. *Fertil Steril*. 1995;63(6):1143-57.
216. Homyk M, Anderson DJ, Wolff H, Herr JC. Differential diagnosis of immature germ cells in semen utilizing monoclonal antibody MHS-10 to the intra-acrosomal antigen SP-10. *Fertil Steril*. 1990;53(2):323-30.
217. Nahoum CR, Cardozo D. Staining for volumetric count of leukocytes in semen and prostrate-vesicular fluid. *Fertil Steril*. 1980;34(1):68-9.

218. Sharma RK, Pasqualotto AE, Nelson DR, Thomas AJ, Jr, Agarwal A. Relationship between seminal white blood cell counts and oxidative stress in men treated at an infertility clinic. *J Androl.* 2001;22(4):575-83.
219. Punab M, Loivukene K, Kermes K, Mandar R. The limit of leucocytospermia from the microbiological viewpoint. *Andrologia.* 2003;35(5):271-8.
220. Aitken RJ, Baker HW. Seminal leukocytes: passengers, terrorists or good samaritans? *Hum Reprod.* 1995;10(7):1736-9.
221. Rossi AG, Aitken RJ. Interactions between leukocytes and the male reproductive system. The unanswered questions. *Adv Exp Med Biol.* 1997;424:245-52.
222. Couture M, Ulstein M, Leonard J, Paulsen CA. Improved staining method for differentiating immature germ cells from white blood cells in human seminal fluid. *Andrologia.* 1976;8(1):61-6.
223. Ezeh UI, Martin M, Cooke ID, Moore HD. Correlation of testicular pathology and sperm extraction in azoospermic men with ejaculated spermatids detected by immunofluorescent localization. *Hum Reprod.* 1998;13(11):3061-5.
224. Barbonetti A, Castellini C, D'Andrea S, Cordeschi G, Santucci R, Francavilla S et al. Prevalence of anti-sperm antibodies and relationship of degree of sperm auto-immunization to semen parameters and post-coital test outcome: a retrospective analysis of over 10 000 men. *Hum Reprod.* 2019;34(5):834-41.
225. Kremer J, Jager S. Characteristics of anti-spermatozoal antibodies responsible for the shaking phenomenon with special regard to immunoglobulin class and antigen-reactive sites. *Int J Androl.* 1980;3(2):143-52.
226. Bronson R, Cooper G, Rosenfeld D. Sperm antibodies: their role in infertility. *Fertil Steril.* 1984;42(2):171-83.
227. Bronson R, Cooper G, Rosenfeld D, Witkin SS. Detection of spontaneously occurring sperm-directed antibodies in infertile couples by immunobead binding and enzyme-linked immunosorbent assay. *Ann N Y Acad Sci.* 1984;438:504-7.
228. Bronson RA. Detection of sperm specific antibodies on the spermatozoa surface by immunobead binding. *Arch Androl.* 1982;9:61.
229. Clarke GN. Immunoglobulin class of sperm-bound antibodies in semen. . In: Bratanov K, editor. *Immunology of Reproduction.* Bulgarian: Bulgarian Academy of Sciences Press; 1982. p. 462-85.
230. Hellstrom WJ, Samuels SJ, Waits AB, Overstreet JW. A comparison of the usefulness of SpermMar and immunobead tests for the detection of antisperm antibodies. *Fertil Steril.* 1989;52(6):1027-31.
231. Scarselli G, Livi C, Chelo E, Dubini V, Pellegrini S. Approach to immunological male infertility: a comparison between MAR test and direct immunobead test. *Acta Eur Fertil.* 1987;18(1):55-7.
232. MacMillan RA, Baker HW. Comparison of latex and polyacrylamide beads for detecting sperm antibodies. *Clin Reprod Fertil.* 1987;5(4):203-9.

233. Meinertz H, Bronson R. Detection of antisperm antibodies on the surface of motile spermatozoa. Comparison of the immunobead binding technique (IBT) and the mixed antiglobulin reaction (MAR). *Am J Reprod Immunol Microbiol.* 1988;18(4):120-3.
234. Abshagen K, Behre HM, Cooper TG, Nieschlag E. Influence of sperm surface antibodies on spontaneous pregnancy rates. *Fertil Steril.* 1998;70(2):355-6.
235. Chiu WW, Chamley LW. Clinical associations and mechanisms of action of antisperm antibodies. *Fertil Steril.* 2004;82(3):529-35.
236. Rajah SV, Parslow JM, Howell RJ, Hendry WF. Comparison of mixed antiglobulin reaction and direct immunobead test for detection of sperm-bound antibodies in subfertile males. *Fertil Steril.* 1992;57(6):1300-3.
237. Gould JE, Brazil CK, Overstreet JW. Sperm-immunobead binding decreases with in vitro incubation. *Fertil Steril.* 1994;62(1):167-71.
238. Barratt CL, Dunphy BC, McLeod I, Cooke ID. The poor prognostic value of low to moderate levels of sperm surface-bound antibodies. *Hum Reprod.* 1992;7(1):95-8.
239. von der Kammer H, Scheit KH, Weidner W, Cooper TG. The evaluation of markers of prostatic function. *Urol Res.* 1991;19(6):343-7.
240. Cooper TG, Weidner W, Nieschlag E. The influence of inflammation of the human male genital tract on secretion of the seminal markers alpha-glucosidase, glycerophosphocholine, carnitine, fructose and citric acid. *Int J Androl.* 1990;13(5):329-36.
241. Moellering H, Gruber W. Determination of citrate with citrate lyase. *Anal Biochem.* 1966;17(3):369-76.
242. Heite HJ, Wetterauer W. [Acid phosphatase in seminal fluid--method of estimation and diagnostic significance]. *Andrologia.* 1979;11(2):113-22.
243. Wang J, Niu Y, Zhang C, Chen Y. A micro-plate colorimetric assay for rapid determination of trace zinc in animal feed, pet food and drinking water by ion masking and statistical partitioning correction. *Food Chem.* 2018;245:337-45.
244. Johnsen O, Eliasson R. Evaluation of a commercially available kit for the colorimetric determination of zinc in human seminal plasma. *Int J Androl.* 1987;10(2):435-40.
245. Cooper TG, Jockenhovel F, Nieschlag E. Variations in semen parameters from fathers. *Hum Reprod.* 1991;6(6):859-66.
246. Björndahl L. Prevalence of high zinc concentrations in 45,000 ejaculates - Unpublished data. 2021.
247. Karvonen MJ, Malm M. Colorimetric determination of fructose with indol. *Scand J Clin Lab Invest.* 1955;7(4):305-7.

248. Paquin R, Chapdelaine P, Dube JY, Tremblay RR. Similar biochemical properties of human seminal plasma and epididymal alpha-1,4-glucosidase. *J Androl.* 1984;5(4):277-82.
249. Cooper TG, Yeung CH, Nashan D, Jockenhovel F, Nieschlag E. Improvement in the assessment of human epididymal function by the use of inhibitors in the assay of alpha-glucosidase in seminal plasma. *Int J Androl.* 1990;13(4):297-305.
250. Björndahl L, Magnusson K, Larsson Chatziantonis M, Holmberg R, Flanagan J. When is a vasectomy successful? Laboratory aspects. *Andrology.* 2019;7, Suppl 1:96-97.
251. MacLeod J, Hotchkiss RS. The Distribution of Spermatozoa and of Certain Chemical Constituents in the Human Ejaculate. *J Urol.* 1942;48(2):225-9.
252. MacLeod J, Gold RZ. The male factor in fertility and infertility. III. An analysis of motile activity in the spermatozoa of 1000 fertile men and 1000 men in infertile marriage. *Fertil Steril.* 1951;2(3):187-204.
253. Björndahl L, Kvist U. Influence of seminal vesicular fluid on the zinc content of human sperm chromatin. *Int J Androl.* 1990;13(3):232-7.
254. Kvist U, Kjellberg S, Björndahl L, Soufir JC, Arver S. Seminal fluid from men with agenesis of the Wolffian ducts: zinc-binding properties and effects on sperm chromatin stability. *Int J Androl.* 1990;13(4):245-52.
255. Björndahl L, Kjellberg S, Kvist U. Ejaculatory sequence in men with low sperm chromatin-zinc. *Int J Androl.* 1991;14(3):174-8.
256. Lindholmer C. Survival of human spermatozoa in different fractions of split ejaculate. *Fertil Steril.* 1973;24(7):521-6.
257. Lundquist F. Aspects of the biochemistry of human semen. . *Acta Physiol Scand.* 1949;19, Suppl 66:1-108.
258. Beiswanger JC, Deaton JL, Jarow JP. Partial ejaculatory duct obstruction causing early demise of sperm. *Urology.* 1998;51(1):125-7.
259. Eisenberg ML, Walsh TJ, Garcia MM, Shinohara K, Turek PJ. Ejaculatory duct manometry in normal men and in patients with ejaculatory duct obstruction. *J Urol.* 2008;180(1):255-60; discussion 60.
260. Fisch H, Kang YM, Johnson CW, Goluboff ET. Ejaculatory duct obstruction. *Curr Opin Urol.* 2002;12(6):509-15.
261. Lotti F, Corona G, Cocci A, Cipriani S, Baldi E, Degl'Innocenti S et al. The prevalence of midline prostatic cysts and the relationship between cyst size and semen parameters among infertile and fertile men. *Hum Reprod.* 2018;33(11):2023-34.
262. Nagler HM, Rotman M, Zoltan E, Fisch H. The natural history of partial ejaculatory duct obstruction. *J Urol.* 2002;167(1):253-4.
263. Onur MR, Orhan I, Firdolas F, Onur R, Kocakoc E. Clinical and radiological evaluation of ejaculatory duct obstruction. *Arch Androl.* 2007;53(4):179-86.

264. Smith JF, Walsh TJ, Turek PJ. Ejaculatory duct obstruction. *Urol Clin North Am.* 2008;35(2):221-7, viii.
265. Turek PJ, Magana JO, Lipshultz LI. Semen parameters before and after transurethral surgery for ejaculatory duct obstruction. *J Urol.* 1996;155(4):1291-3.
266. Avellino GJ, Lipshultz LI, Sigman M, Hwang K. Transurethral resection of the ejaculatory ducts: etiology of obstruction and surgical treatment options. *Fertil Steril.* 2019;111(3):427-43.
267. Chan PTK, Aube M. Infertility due to ejaculatory duct obstruction can be surgically corrected—a forgotten lesson in male reproductive urology. *Fertil Steril.* 2018;110(7):1275-6.
268. El-Assmy A, El-Tholoth H, Abouelkheir RT, Abou-El-Ghar ME. Transurethral resection of ejaculatory duct in infertile men: outcome and predictors of success. *Int Urol Nephrol.* 2012;44(6):1623-30.
269. Halpern JA, Brannigan RE, Schlegel PN. Fertility-enhancing male reproductive surgery: glimpses into the past and thoughts for the future. *Fertil Steril.* 2019;112(3):426-37.
270. Kadioglu A, Cayan S, Tefekli A, Orhan I, Engin G, Turek PJ. Does response to treatment of ejaculatory duct obstruction in infertile men vary with pathology? *Fertil Steril.* 2001;76(1):138-42.
271. McQuaid JW, Tanrikut C. Ejaculatory duct obstruction: current diagnosis and treatment. *Curr Urol Rep.* 2013;14(4):291-7.
272. Fisch H, Lambert SM, Goluboff ET. Management of ejaculatory duct obstruction: etiology, diagnosis, and treatment. *World J Urol.* 2006;24(6):604-10.
273. Mortimer D, Björndahl L, Barratt CLR, Castilla JA, Menkveld R, Kvist U et al. A practical guide to basic laboratory andrology. 1st ed. Cambridge, UK ; New York: Cambridge University Press; In Press.
274. Amelar RD, Hotchkiss RS. The Split Ejaculate: Its Use in the Management of Male Infertility. *Fertil Steril.* 1965;16:46-60.
275. Eisenberg ML, Li S, Behr B, Pera RR, Cullen MR. Relationship between semen production and medical comorbidity. *Fertil Steril.* 2015;103(1):66-71.
276. Selvaraju V, Baskaran S, Agarwal A, Henkel R. Environmental contaminants and male infertility: Effects and mechanisms. *Andrologia.* 2020:e13646.
277. Levine H, Jorgensen N, Martino-Andrade A, Mendiola J, Weksler-Derri D, Mindlis I et al. Temporal trends in sperm count: a systematic review and meta-regression analysis. *Hum Reprod Update.* 2017;23(6):646-59.
278. Muratori M, De Geyter C. Chromatin condensation, fragmentation of DNA and differences in the epigenetic signature of infertile men. *Best Pract Res Clin Endocrinol Metab.* 2019;33(1):117-26.

279. Jones R, Mann T, Sherins R. Peroxidative breakdown of phospholipids in human spermatozoa, spermicidal properties of fatty acid peroxides, and protective action of seminal plasma. *Fertil Steril*. 1979;31(5):531-7.
280. Alvarez JG, Touchstone JC, Blasco L, Storey BT. Spontaneous lipid peroxidation and production of hydrogen peroxide and superoxide in human spermatozoa. Superoxide dismutase as major enzyme protectant against oxygen toxicity. *J Androl*. 1987;8(5):338-48.
281. Aitken RJ, Clarkson JS. Cellular basis of defective sperm function and its association with the genesis of reactive oxygen species by human spermatozoa. *J Reprod Fertil*. 1987;81(2):459-69.
282. Bisht S, Dada R. Oxidative stress: Major executioner in disease pathology, role in sperm DNA damage and preventive strategies. *Front Biosci (Schol Ed)*. 2017;9:420-47.
283. O'Flaherty C, Matsushita-Fournier D. Reactive oxygen species and protein modifications in spermatozoa. *Biol Reprod*. 2017;97(4):577-85.
284. Aitken RJ. Impact of oxidative stress on male and female germ cells: implications for fertility. *Reproduction*. 2020;159(4):R189-R201.
285. Dias TR. Measurement of Reactive Oxygen Species in Semen Samples Using Chemiluminescence. *Methods Mol Biol*. 2021;2202:103-9.
286. Miller NJ, Rice-Evans C, Davies MJ. A new method for measuring antioxidant activity. *Biochem Soc Trans*. 1993;21(2):95S.
287. Miller NJ, Rice-Evans CA. Factors influencing the antioxidant activity determined by the ABTS+ radical cation assay. *Free Radic Res*. 1997;26(3):195-9.
288. Xu F, Guo G, Zhu W, Fan L. Human sperm acrosome function assays are predictive of fertilization rate in vitro: a retrospective cohort study and meta-analysis. *Reprod Biol Endocrinol*. 2018;16(1):81.
289. Franken DR, Bastiaan HS, Oehninger SC. Physiological induction of the acrosome reaction in human sperm: validation of a microassay using minimal volumes of solubilized, homologous zona pellucida. *J Assist Reprod Genet*. 2000;17(3):156-61.
290. Tamburrino L, Marchiani S, Muratori M, Luconi M, Baldi E. Progesterone, spermatozoa and reproduction: An updated review. *Mol Cell Endocrinol*. 2020;516:110952.
291. Liu DY, Baker HW. Relationship between the zona pellucida (ZP) and ionophore A23187-induced acrosome reaction and the ability of sperm to penetrate the ZP in men with normal sperm-ZP binding. *Fertil Steril*. 1996;66(2):312-5.
292. Fierro R, Foliguet B, Grignon G, Daniel M, Bene MC, Faure GC et al. Lectin-binding sites on human sperm during acrosome reaction: modifications judged by electron microscopy/flow cytometry. *Arch Androl*. 1996;36(3):187-96.



293. Cross N. Methods for evaluating the acrosomal status of human sperm. In: Fenichel P, Parinaud J, editors. Human sperm acrosome reaction. Colloques INSERM. Paris: John Libbey Eurotext; 1995. p. 277-85.
294. Aitken RJ, Buckingham DW, Fang HG. Analysis of the responses of human spermatozoa to A23187 employing a novel technique for assessing the acrosome reaction. *J Androl.* 1993;14(2):132-41.
295. Jin SK, Yang WX. Factors and pathways involved in capacitation: how are they regulated? *Oncotarget.* 2017;8(2):3600-27.
296. Cross N. Two simple methods for detecting acrosome-reacted human sperm. *Gamete Research.* 1986;15:213-26.
297. Mortimer D, Curtis EF, Miller RG. Specific labelling by peanut agglutinin of the outer acrosomal membrane of the human spermatozoon. *J Reprod Fertil.* 1987;81(1):127-35.
298. Pember S, Jequier A, Yovich J. A Test of the Human Sperm Acrosome Reaction Following Ionophore Challenge Relationship to Fertility and Other Seminal Parameters. *Journal of andrology.* 1991;12:98-103.
299. Krausz C, Bonaccorsi L, Maggio P, Luconi M, Criscuoli L, Fuzzi B et al. Two functional assays of sperm responsiveness to progesterone and their predictive values in in-vitro fertilization. *Hum Reprod.* 1996;11(8):1661-7.
300. Björndahl L, Kvist U. A model for the importance of zinc in the dynamics of human sperm chromatin stabilization after ejaculation in relation to sperm DNA vulnerability. *Syst Biol Reprod Med.* 2011;57(1-2):86-92.
301. Colaco S, Sakkas D. Paternal factors contributing to embryo quality. *J Assist Reprod Genet.* 2018;35(11):1953-68.
302. Marchiani S, Tamburrino L, Benini F, Fanfani L, Dolce R, Rastrelli G et al. Chromatin Protamination and Catsper Expression in Spermatozoa Predict Clinical Outcomes after Assisted Reproduction Programs. *Sci Rep.* 2017;7(1):15122.
303. Marchiani S, Tamburrino L, Olivito B, Betti L, Azzari C, Forti G et al. Characterization and sorting of flow cytometric populations in human semen. *Andrology.* 2014;2(3):394-401.
304. Smith JF, Syritsyna O, Fellous M, Serres C, Mannowetz N, Kirichok Y et al. Disruption of the principal, progesterone-activated sperm Ca<sup>2+</sup> channel in a CatSper2-deficient infertile patient. *Proc Natl Acad Sci U S A.* 2013;110(17):6823-8.
305. Ren D, Navarro B, Perez G, Jackson AC, Hsu S, Shi Q et al. A sperm ion channel required for sperm motility and male fertility. *Nature.* 2001;413(6856):603-9.
306. Brown SG, Publicover SJ, Barratt CLR, Martins da Silva SJ. Human sperm ion channel (dys)function: implications for fertilization. *Hum Reprod Update.* 2019;25(6):758-76.

307. Luo T, Chen HY, Zou QX, Wang T, Cheng YM, Wang HF et al. A novel copy number variation in CATSPER2 causes idiopathic male infertility with normal semen parameters. *Hum Reprod.* 2019;34(3):414-23.
308. Kelly MC, Brown SG, Costello SM, Ramalingam M, Drew E, Publicover SJ et al. Single-cell analysis of [Ca<sup>2+</sup>]<sub>i</sub> signalling in sub-fertile men: characteristics and relation to fertilization outcome. *Hum Reprod.* 2018;33(6):1023-33.
309. Davis RO, Katz DF. Standardization and comparability of CASA instruments. *J Androl.* 1992;13(1):81-6.
310. Mortimer D, Mortimer S, editors. Routine application of CASA in human clinical andrology and ART laboratories. 13th International Symposium on Spermatology; 2018; Stockholm New York: Springer; 2021.
311. Mortimer D, Aitken RJ, Mortimer ST, Pacey AA. Workshop report: clinical CASA--the quest for consensus. *Reproduction, fertility, and development.* 1995;7(4):951-9.
312. ESHRE Special Interest Group in Andrology. Guidelines on the application of CASA technology in the analysis of spermatozoa. 1998 Jan. Report No.: 0268-1161 (Print) Contract No.: 13.
313. Freour T, Jean M, Mirallie S, Barriere P. Computer-assisted sperm analysis parameters in young fertile sperm donors and relationship with age. *Syst Biol Reprod Med.* 2012;58(2):102-6.
314. Yuan P, Zhang Z, Luo C, Quan S, Chu Q, Zhao S. [Computer-assisted sperm analysis for assessing sperm motility parameters in in vitro fertilization]. *Nan Fang Yi Ke Da Xue Xue Bao.* 2013;33(3):448-50.
315. Cupples G, Gallagher MT, Smith AU, Kirkman-Brown J, editors. Heads and tails. Requirements for informative and robust computational measures of sperm motility. 13th International Symposium on Spermatology; 2018; Stockholm. New York: Springer; 2021.
316. Gallagher MT, Cupples G, Ooi EH, Kirkman-Brown JC, Smith DJ. Rapid sperm capture: high-throughput flagellar waveform analysis. *Hum Reprod.* 2019;34(7):1173-85.
317. Mortimer ST. A critical review of the physiological importance and analysis of sperm movement in mammals. *Hum Reprod Update.* 1997;3(5):403-39.
318. Zhu JJ, Pacey AA, Barratt CL, Cooke ID. Computer-assisted measurement of hyperactivation in human spermatozoa: differences between European and American versions of the Hamilton-Thorn motility analyser. *Hum Reprod.* 1994;9(3):456-62.
319. Mortimer D, Mortimer ST. Computer-Aided Sperm Analysis (CASA) of sperm motility and hyperactivation. *Methods Mol Biol.* 2013;927:77-87.
320. Goodson SG, White S, Stevans AM, Bhat S, Kao CY, Jaworski S et al. CASAnova: a multiclass support vector machine model for the classification of human sperm motility patterns. *Biol Reprod.* 2017;97(5):698-708.

321. Ooi EH, Smith DJ, Gadelha H, Gaffney EA, Kirkman-Brown J. The mechanics of hyperactivation in adhered human sperm. *R Soc Open Sci*. 2014;1(2):140230.
322. Garrett C, Baker HW. A new fully automated system for the morphometric analysis of human sperm heads. *Fertil Steril*. 1995;63(6):1306-17.
323. Lacquet FA, Kruger TF, Du Toit TC, Lombard CJ, Sanchez Sarmiento CA, De Villiers A et al. Slide preparation and staining procedures for reliable results using computerized morphology. *Arch Androl*. 1996;36(2):133-8.
324. Menkveld R, Lacquet FA, Kruger TF, Lombard CJ, Sanchez Sarmiento CA, de Villiers A. Effects of different staining and washing procedures on the results of human sperm morphology evaluation by manual and computerised methods. *Andrologia*. 1997;29(1):1-7.
325. Coetzee K, Kruger TF, Lombard CJ. Repeatability and variance analysis on multiple computer-assisted (IVOS) sperm morphology readings. *Andrologia*. 1999;31(3):163-8.
326. Coetzee K, Kruger TF, Lombard CJ, Shaughnessy D, Oehninger S, Ozgur K et al. Assessment of interlaboratory and intralaboratory sperm morphology readings with the use of a Hamilton Thorne Research integrated visual optical system semen analyzer. *Fertil Steril*. 1999;71(1):80-4.
327. Coetzee K, de Villiers A, Kruger TF, Lombard CJ. Clinical value of using an automated sperm morphology analyzer (IVOS). *Fertil Steril*. 1999;71(2):222-5.
328. An LM, Ma JH, Li WW, Xia XY, Huang YF, Wang WB. [Flow cytometry for evaluation of sperm plasma membrane integrity in varicocele patients]. *Zhonghua Nan Ke Xue*. 2011;17(11):984-8.
329. Isobe T. New method to estimate the possibility of natural pregnancy using computer-assisted sperm analysis. *Syst Biol Reprod Med*. 2012;58(6):339-47.
330. Yaniz JL, Vicente-Fiel S, Soler C, Recreo P, Carretero T, Bono A et al. Comparison of different statistical approaches to evaluate morphometric sperm subpopulations in men. *Asian J Androl*. 2016;18(6):819-23.
331. Lu JC, Huang YF, Lu NQ. Computer-aided sperm analysis: past, present and future. *Andrologia*. 2014;46(4):329-38.
332. Vested A, Ramlau-Hansen CH, Bonde JP, Thulstrup AM, Kristensen SL, Toft G. A comparison of conventional and computer-assisted semen analysis (CRISMAS software) using samples from 166 young Danish men. *Asian J Androl*. 2011;13(3):453-8.
333. Hu YA, Lu JC, Shao Y, Huang YF, Lu NQ. Comparison of the semen analysis results obtained from two branded computer-aided sperm analysis systems. *Andrologia*. 2013;45(5):315-8.
334. Dearing C, Jayasena C, Lindsay K. Can the Sperm Class Analyser (SCA) CASA-Mot system for human sperm motility analysis reduce imprecision and operator subjectivity and improve semen analysis? *Hum Fertil (Camb)*. 2019:1-11.

335. Dearing CG, Kilburn S, Lindsay KS. Validation of the sperm class analyser CASA system for sperm counting in a busy diagnostic semen analysis laboratory. *Hum Fertil (Camb)*. 2014;17(1):37-44.
336. Kose M, Sokmensuer LK, Demir A, Bozdog G, Gunalp S. Manual versus computer-automated semen analysis. *Clin Exp Obstet Gynecol*. 2014;41(6):662-4.
337. Lammers J, Splingart C, Barriere P, Jean M, Freour T. Double-blind prospective study comparing two automated sperm analyzers versus manual semen assessment. *J Assist Reprod Genet*. 2014;31(1):35-43.
338. Urbano LF, Masson P, VerMilyea M, Kam M. Automatic Tracking and Motility Analysis of Human Sperm in Time-Lapse Images. *IEEE Trans Med Imaging*. 2017;36(3):792-801.
339. Wei SY, Chao HH, Huang HP, Hsu CF, Li SH, Hsu L. A collective tracking method for preliminary sperm analysis. *Biomed Eng Online*. 2019;18(1):112.
340. Elsayed M, El-Sherry TM, Abdelgawad M. Development of computer-assisted sperm analysis plugin for analyzing sperm motion in microfluidic environments using Image-J. *Theriogenology*. 2015;84(8):1367-77.
341. Kobori Y, Pfanner P, Prins GS, Niederberger C. Novel device for male infertility screening with single-ball lens microscope and smartphone. *Fertil Steril*. 2016;106(3):574-8.
342. Holmes E, Bjorndahl L, Kvist U. Hypotonic challenge reduces human sperm motility through coiling and folding of the tail. *Andrologia*. 2020:e13859.
343. Mortimer ST, Swan MA, Mortimer D. Effect of seminal plasma on capacitation and hyperactivation in human spermatozoa. *Hum Reprod*. 1998;13(8):2139-46.
344. Canale D, Giorgi PM, Gasperini M, Pucci E, Barletta D, Gasperi M et al. Inter and intra-individual variability of sperm morphology after selection with three different techniques: layering, swimup from pellet and percoll. *J Endocrinol Invest*. 1994;17(9):729-32.
345. Henkel R. Sperm preparation: state-of-the-art--physiological aspects and application of advanced sperm preparation methods. *Asian J Androl*. 2012;14(2):260-9.
346. Volpes A, Sammartano F, Rizzari S, Gullo S, Marino A, Allegra A. The pellet swim-up is the best technique for sperm preparation during in vitro fertilization procedures. *J Assist Reprod Genet*. 2016;33(6):765-70.
347. Henkel RR, Schill WB. Sperm preparation for ART. *Reprod Biol Endocrinol*. 2003;1:108.
348. Aitken RJ, Clarkson JS. Significance of reactive oxygen species and antioxidants in defining the efficacy of sperm preparation techniques. *J Androl*. 1988;9(6):367-76.
349. Iwasaki A, Gagnon C. Formation of reactive oxygen species in spermatozoa of infertile patients. *Fertil Steril*. 1992;57(2):409-16.

350. Boomsma CM, Heineman MJ, Cohlen BJ, Farquhar C. Semen preparation techniques for intrauterine insemination. *Cochrane Database Syst Rev*. 2007(4):Cd004507.
351. Simon L, Emery B, Carrell DT. Sperm DNA Fragmentation: Consequences for Reproduction. *Adv Exp Med Biol*. 2019;1166:87-105.
352. Jayaraman V, Upadhy D, Narayan PK, Adiga SK. Sperm processing by swim-up and density gradient is effective in elimination of sperm with DNA damage. *J Assist Reprod Genet*. 2012;29(6):557-63.
353. Aitken RJ, Finnie JM, Muscio L, Whiting S, Connaughton HS, Kuczera L et al. Potential importance of transition metals in the induction of DNA damage by sperm preparation media. *Hum Reprod*. 2014;29(10):2136-47.
354. Muratori M, Tarozzi N, Cambi M, Boni L, Iorio AL, Passaro C et al. Variation of DNA Fragmentation Levels During Density Gradient Sperm Selection for Assisted Reproduction Techniques: A Possible New Male Predictive Parameter of Pregnancy? *Medicine (Baltimore)*. 2016;95(20):e3624.
355. Björndahl L, Mohammadi M, Pourian M, Soderlund I, Kvist U. Contamination by seminal plasma factors during sperm selection. *J Androl*. 2005;26(2):170-3.
356. Oseguera-Lopez I, Ruiz-Diaz S, Ramos-Ibeas P, Perez-Cerezales S. Novel Techniques of Sperm Selection for Improving IVF and ICSI Outcomes. *Front Cell Dev Biol*. 2019;7:298.
357. International Standards Organization. ISO 15189:2012 Medical Laboratories – Requirements for Quality and Competence. Geneva 2012.
358. Lepine S, McDowell S, Searle LM, Kroon B, Glujovsky D, Yazdani A. Advanced sperm selection techniques for assisted reproduction. *Cochrane Database Syst Rev*. 2019;7:CD010461.
359. Bucar S, Goncalves A, Rocha E, Barros A, Sousa M, Sa R. DNA fragmentation in human sperm after magnetic-activated cell sorting. *J Assist Reprod Genet*. 2015;32(1):147-54.
360. Zafer M, Horvath H, Mmeje O, van der Poel S, Semprini AE, Rutherford G et al. Effectiveness of semen washing to prevent human immunodeficiency virus (HIV) transmission and assist pregnancy in HIV-discordant couples: a systematic review and meta-analysis. *Fertil Steril*. 2016;105(3):645-55 e2.
361. Gilling-Smith C, Nicopoullou JD, Semprini AE, Frodsham LC. HIV and reproductive care--a review of current practice. *BJOG*. 2006;113(8):869-78.
362. Savasi V, Ferrazzi E, Lanzani C, Oneta M, Parrilla B, Persico T. Safety of sperm washing and ART outcome in 741 HIV-1-serodiscordant couples. *Hum Reprod*. 2007;22(3):772-7.
363. Fourie JM, Loskutoff N, Huyser C. Semen decontamination for the elimination of seminal HIV-1. *Reprod Biomed Online*. 2015;30(3):296-302.

364. Gilling-Smith C, Emiliani S, Almeida P, Liesnard C, Englert Y. Laboratory safety during assisted reproduction in patients with blood-borne viruses. *Hum Reprod.* 2005;20(6):1433-8.
365. Loutfy MR, Wu W, Letchumanan M, Bondy L, Antoniou T, Margolese S et al. Systematic review of HIV transmission between heterosexual serodiscordant couples where the HIV-positive partner is fully suppressed on antiretroviral therapy. *PLoS One.* 2013;8(2):e55747.
366. LeMessurier J, Traversy G, Varsaneux O, Weekes M, Avey MT, Niragira O et al. Risk of sexual transmission of human immunodeficiency virus with antiretroviral therapy, suppressed viral load and condom use: a systematic review. *CMAJ.* 2018;190(46):E1350-E60.
367. Rodger AJ, Cambiano V, Bruun T, Vernazza P, Collins S, van Lunzen J et al. Sexual Activity Without Condoms and Risk of HIV Transmission in Serodifferent Couples When the HIV-Positive Partner Is Using Suppressive Antiretroviral Therapy. *JAMA.* 2016;316(2):171-81.
368. Del Romero J, Rio I, Castilla J, Baza B, Paredes V, Vera M et al. Absence of transmission from HIV-infected individuals with HAART to their heterosexual serodiscordant partners. *Enferm Infecc Microbiol Clin.* 2015;33(10):666-72.
369. Mahadevan M, Leeton JF, Trounson AO. Noninvasive method of semen collection for successful artificial insemination in a case of retrograde ejaculation. *Fertil Steril.* 1981;36(2):243-7.
370. Bunge RG, Keettel WC, Sherman JK. Clinical use of frozen semen: report of four cases. *Fertil Steril.* 1954;5(6):520-9.
371. Bunge RG, Sherman JK. Fertilizing capacity of frozen human spermatozoa. *Nature.* 1953;172(4382):767-8.
372. Polge C, Smith AU, Parkes AS. Revival of spermatozoa after vitrification and dehydration at low temperatures. *Nature.* 1949;164(4172):666.
373. Clarke GN, Bourne H, Hill P, Johnston WI, Speirs A, McBain JC et al. Artificial insemination and in-vitro fertilization using donor spermatozoa: a report on 15 years of experience. *Hum Reprod.* 1997;12(4):722-6.
374. David G, Czyglik F, Mayaux MJ, Martin-Boyce A, Schwartz D. Artificial insemination with frozen sperm: protocol, method of analysis and results for 1188 women. *Br J Obstet Gynaecol.* 1980;87(11):1022-8.
375. Leibo SP, Songsasen N. Cryopreservation of gametes and embryos of non-domestic species. *Theriogenology.* 2002;57(1):303-26.
376. Perloff WH, Steinberger E, Sherman JK. Conception with Human Spermatozoa Frozen by Nitrogen Vapor Technic. *Fertil Steril.* 1964;15:501-4.
377. Mortimer D. Current and future concepts and practices in human sperm cryobanking. *Reprod Biomed Online.* 2004;9(2):134-51.

378. Keel BA, Webster BW. Semen cryopreservation methodology and results. In: Barratt CLR, Cooke ID, editors. Donor insemination. Cambridge: Cambridge University Press; 1993. p. 71-96.
379. Sherman JK. Cryopreservation of human semen. In: Keel BA, Webster BW, editors. CRC handbook of the laboratory diagnosis and treatment of infertility. Boca Raton: CRC Press 1990. p. 229-59.
380. Watson PF. Recent developments and concepts in the cryopreservation of spermatozoa and the assessment of their post-thawing function. *Reproduction, fertility, and development*. 1995;7(4):871-91.
381. Clarke GN, Liu DY, Baker HW. Improved sperm cryopreservation using cold cryoprotectant. *Reproduction, fertility, and development*. 2003;15(7-8):377-81.
382. Nijs M, Creemers E, Cox A, Janssen M, Vanheusden E, Castro-Sanchez Y et al. Influence of freeze-thawing on hyaluronic acid binding of human spermatozoa. *Reprod Biomed Online*. 2009;19(2):202-6.
383. Guan HT, Zheng Y, Wang JJ, Meng TQ, Xia W, Hu SH et al. Relationship between donor sperm parameters and pregnancy outcome after intrauterine insemination: analysis of 2821 cycles in 1355 couples. *Andrologia*. 2016;48(1):29-36.
384. Clarke GN, Liu DY, Baker HW. Recovery of human sperm motility and ability to interact with the human zona pellucida after more than 28 years of storage in liquid nitrogen. *Fertil Steril*. 2006;86(3):721-2.
385. Feldschuh J, Brassel J, Durso N, Levine A. Successful sperm storage for 28 years. *Fertil Steril*. 2005;84(4):1017.
386. Sharma R, Kattoor AJ, Ghulmiyyah J, Agarwal A. Effect of sperm storage and selection techniques on sperm parameters. *Syst Biol Reprod Med*. 2015;61(1):1-12.
387. Oktay K, Harvey BE, Partridge AH, Quinn GP, Reinecke J, Taylor HS et al. Fertility Preservation in Patients With Cancer: ASCO Clinical Practice Guideline Update. *J Clin Oncol*. 2018;36(19):1994-2001.
388. Corona G, Minhas S, Giwercman A, Bettocchi C, Dinkelman-Smit M, Dohle G et al. Sperm recovery and ICSI outcomes in men with non-obstructive azoospermia: a systematic review and meta-analysis. *Hum Reprod Update*. 2019;25(6):733-57.
389. Kuczyński W, Dhont M, Grygoruk C, Grochowski D, Wołczyński S, Szamatowicz M. The outcome of intracytoplasmic injection of fresh and cryopreserved ejaculated spermatozoa—a prospective randomized study. *Hum Reprod*. 2001;16(10):2109-13.
390. Nicopoulos JD, Gilling-Smith C, Ramsay JW. Does the cause of obstructive azoospermia affect the outcome of intracytoplasmic sperm injection: a meta-analysis. *BJU Int*. 2004;93(9):1282-6.
391. Hezavehei M, Sharafi M, Kouchesfahani HM, Henkel R, Agarwal A, Esmaili V et al. Sperm cryopreservation: A review on current molecular cryobiology and advanced approaches. *Reprod Biomed Online*. 2018;37(3):327-39.

392. Li K, Rodriguez D, Gabrielsen JS, Centola GM, Tanrikut C. Sperm cryopreservation of transgender individuals: trends and findings in the past decade. *Andrology*. 2018;6(6):860-4.
393. Starmer BZ, Baird A, Lucky MA. Considerations in fertility preservation in cases of testicular trauma. *BJU Int*. 2018;121(3):466-71.
394. Kamischke A, Jürgens H, Hertle L, Berdel WE, Nieschlag E. Cryopreservation of Sperm From Adolescents and Adults With Malignancies. *J Androl*. 2004;25(4):586-92.
395. Bourne H, Richings N, Liu DY, Clarke GN, Harari O, Baker HW. Sperm preparation for intracytoplasmic injection: methods and relationship to fertilization results. *Reproduction, fertility, and development*. 1995;7(2):177-83.
396. Hawksworth DJ, Szafran AA, Jordan PW, Dobs AS, Herati AS. Infertility in Patients With Klinefelter Syndrome: Optimal Timing for Sperm and Testicular Tissue Cryopreservation. *Rev Urol*. 2018;20(2):56-62.
397. Kirkman-Brown JC, Martins MV. 'Genes versus children': if the goal is parenthood, are we using the optimal approach? *Hum Reprod*. 2020;35(1):5-11.
398. Parmegiani L, Accorsi A, Bernardi S, Arnone A, Cognigni GE, Filicori M. A reliable procedure for decontamination before thawing of human specimens cryostored in liquid nitrogen: three washes with sterile liquid nitrogen (SLN2). *Fertil Steril*. 2012;98(4):870-5.
399. Tedder RS, Zuckerman MA, Goldstone AH, Hawkins AE, Fielding A, Briggs EM et al. Hepatitis B transmission from contaminated cryopreservation tank. *Lancet*. 1995;346(8968):137-40.
400. Tomlinson M. Managing risk associated with cryopreservation. *Hum Reprod*. 2005;20(7):1751-6.
401. Perez-Sanchez F, Cooper TG, Yeung CH, al. e. Improvement in quality of cryopreserved human spermatozoa by swim-up before freezing. *Int J Androl*. 1994;17(3):115-20.
402. Machen GL, Harris SE, Bird ET, Brown ML, Ingalsbe DA, East MM et al. Utilization of cryopreserved sperm cells based on the indication for storage. *Investig Clin Urol*. 2018;59(3):177-81.
403. Liu S, Li F. Cryopreservation of single-sperm: where are we today? *Reprod Biol Endocrinol*. 2020;18(1):41.
404. Isachenko V, Rahimi G, Mallmann P, Sanchez R, Isachenko E. Technologies of cryoprotectant-free vitrification of human spermatozoa: asepticity as criterion of effectiveness. *Andrology*. 2017;5(6):1055-63.
405. Berkovitz A, Miller N, Silberman M, Belenky M, Itsykson P. A novel solution for freezing small numbers of spermatozoa using a sperm vitrification device. *Hum Reprod*. 2018;33(11):1975-83.



406. Li YX, Zhou L, Lv MQ, Ge P, Liu YC, Zhou DX. Vitrification and conventional freezing methods in sperm cryopreservation: A systematic review and meta-analysis. *Eur J Obstet Gynecol Reprod Biol.* 2019;233:84-92.
407. Sánchez, R., Risopatrón, J., Schulz, M., Villegas, J. V., Isachenko, V., & Isachenko, E. Vitrified sperm banks: the new aseptic technique for human spermatozoa allows cryopreservation at -86 °C. *Andrologia.* 2012; 44(6):433-435.
408. Schulz, M., Risopatrón, J., Uribe, P., Isachenko, E., Isachenko, V., & Sánchez, R. Human sperm vitrification: A scientific report. *Andrology.* 2020;8(6):1642-1650.
409. Cooper TG, Atkinson AD, Nieschlag E. Experience with external quality control in spermatology. *Hum Reprod.* 1999;14(3):765-9.
410. Cooper TG, Björndahl L, Vreeburg J, Nieschlag E. Semen analysis and external quality control schemes for semen analysis need global standardization. *Int J Androl.* 2002;25(5):306-11.
411. Matson PL. External quality assessment for semen analysis and sperm antibody detection: results of a pilot scheme. *Hum Reprod.* 1995;10(3):620-5.
412. Mortimer D, Björndahl L, Barratt CLR, Castilla JA, Menkveld R, Kvist U et al. A practical guide to basic laboratory andrology. 1st ed. Cambridge, UK ; New York: Cambridge University Press; In Press.
413. Neuwinger J, Behre HM, Nieschlag E. External quality control in the andrology laboratory: an experimental multicenter trial. *Fertil Steril.* 1990;54(2):308-14.
414. Mortimer ST, Mortimer D. Quality and Risk Management in the IVF Laboratory. 2nd ed. Cambridge: Cambridge University Press; 2015:402.
415. Westgard JO. Foreword to the second edition. In: Westgard JO, editor. Basic QC practices: training in statistical quality control for healthcare laboratories. Madison, WI, USA: QC Publishing; 2002.
416. Bohring C, Krause W. The intra- and inter-assay variation of the indirect mixed antiglobulin reaction test: is a quality control suitable? *Hum Reprod.* 1999;14(7):1802-5.
417. Kuster CE, Singer RS, Althouse GC. Determining sample size for the morphological assessment of sperm. *Theriogenology.* 2004;61(4):691-703.
418. Bland JM, Altman DG. Statistical methods for assessing agreement between two methods of clinical measurement. *Lancet.* 1986;1(8476):307-10.
419. Armitage P, Berry G, Matthews J. Statistical methods in medical research. Oxford: Blackwell Science; 2002:826
420. Motulsky H. Intuitive Biostatistics - A nonmathematical guide to statistical thinking. 4th ed. Oxford: Oxford University Press; 2017:608
421. Burtis CA, Ashwood ER. Tietz textbook of clinical chemistry. Philadelphia London Toronto Montreal Sydney Tokyo W.B. SAUNDERS COMPANY 1999:1917

422. Plaut DA, Westgard JOW. DC external quality assessment. In: Westgard JO, editor. Basic QC practices: training in statistical quality control for healthcare laboratories. Madison, WI, USA: QC Publishing; 2002. p. 125-63.
423. Cembrowski GS, Carey RN. Laboratory quality management. Chicago: ASCP Press; 1989.
424. Cooper TG, Noonan E, von Eckardstein S, Auger J, Baker HW, Behre HM et al. World Health Organization reference values for human semen characteristics. Hum Reprod Update. 2010;16(3):231-45.
425. Ford WC. Comments on the release of the 5th edition of the WHO Laboratory Manual for the Examination and Processing of Human Semen. Asian J Androl. 2010;12(1):59-63.
426. MacLeod J, Gold RZ. The male factor in fertility and infertility. II. Spermatozoon counts in 1000 men of known fertility and in 1000 cases of infertile marriage. The Journal of urology. 1951;66(3):436-49.
427. Boyd JC. Defining laboratory reference values and decision limits: populations, intervals, and interpretations. Asian J Androl. 2010;12(1):83-90.
428. Björndahl L, Barratt CL, Mortimer D, Jouannet P. 'How to count sperm properly': checklist for acceptability of studies based on human semen analysis. Human reproduction (Oxford, England). 2016;31(2):227-32.
429. Ozarda Y, Sikaris K, Streichert T, Macri J, intervals ICoR, Decision L. Distinguishing reference intervals and clinical decision limits - A review by the IFCC Committee on Reference Intervals and Decision Limits. Crit Rev Clin Lab Sci. 2018;55(6):420-31.
430. Ceriotti F, Henny J. "Are my Laboratory Results Normal?" Considerations to be Made Concerning Reference Intervals and Decision Limits. EJIFCC. 2008;19(2):106-14.
431. Gomez E, Aitken J. Impact of in vitro fertilization culture media on peroxidative damage to human spermatozoa. Fertil Steril. 1996;65(4):880-2.
432. Mortimer D, Mortimer ST. Essential features in media development for spermatozoa, oocytes and embryos. In: Quinn P, editor. Culture Media, Solutions and Systems in Human ART. Cambridge: Cambridge University Press; 2014. p. 47-67.
433. Biggers JD, Whitten WK, Whittingham DG. The culture of mouse embryos in vitro. In: Daniel JC, editor. Methods in Mammalian Embryology. San Francisco, CA, USA: Freeman; 1971. p. 86-116.
434. Quinn P, Kerin JF, Warnes GM. Improved pregnancy rate in human in vitro fertilization with the use of a medium based on the composition of human tubal fluid. Fertil Steril. 1985;44(4):493-8.
435. Hotchkiss RS. Fertility in man. London: William Heineman Medical Books; 1945.
436. Eliasson R. Standards for investigation of human semen. Andrologia. 1971;3:49-64.
437. Lentner C. Geigy scientific tables. Vol. 1: Units of measurement, body fluids, composition of the body, nutrition. Basle: Ciba-Geigy Ltd; 1981:50.



9789240030787



9 789240 030787